

“C”

Glare Impact Study

Memorandum

Date: November 12, 2019
To: Aaron Halimi, RP Napa Solar 2, LLC
From: Thomas Cleveland
Subject: Project ID P19-00338-UP: RP Napa Solar 2, LLC Conditional Use Permit County of Napa Planning Division Response to Additional Questions Regarding the Glare Study

Summary of Findings

In sum, the solar glare analysis determined the project will not produce glare that would result in a safety hazard to aviation, regardless of the time of year or day.

In response to questions raised by Staff via email on November 5th, 2019, please see below:

1. What are the glare consultant's qualifications for, and past experience in conducting aviation hazard and airport land use compatibility evaluations?

I have worked as a technical expert and engineer in solar energy for 15 years. I have provided expert testimony for over 100 solar projects throughout the United States, analyzing (among other things) potential aesthetic, glare, or safety hazard impacts from those projects. Over the past four years, I have conducted glare impact analyses and studies for approximately 20 utility-scale photovoltaic system near public and military airports.

Before joining the private sector, I worked at North Carolina State University's Clean Energy Technology Center. I received a B.S. and M.S. degrees in mechanical engineering from North Carolina State University, where I studied optics, radiation energy transfer, and solar energy.

2. What are the applicable local, state and federal thresholds/criteria for glare impact significance to aviation?

The Federal Aviation Administration (FAA) is the governing body regulating all aspects of civil aviation, including air safety and the use of navigable airspace. The FAA developed guidelines specific to assessing the potential for glare impacts to airports from solar facilities. These guidelines are set forth in *Interim Policy, FAA Review of Solar Energy System Projects on Federally Obligated Airports* (78 Fed. Reg. 63276; the "FAA Solar Guidelines").

The FAA Solar Guidelines set forth the criteria whether solar glare impacts from a PV facility impact air safety and the use of navigable airspace:

To obtain FAA approval to revise an airport layout plan to depict a solar installation and/or a 'no objection' to a [solar installation], the airport sponsor will be required to demonstrate that the proposed solar energy system meets the following standards:

1. No potential for glint or glare in the existing or planned Airport Traffic Control Tower (ATCT) cab, and

2. *No potential for glare or 'low potential for after-image' . . . along the final approach path for any existing landing threshold* or future landing thresholds . . . as shown on the current FAA-approved Airport Layout Plan (ALP). The final approach path is defined as two (2) miles from fifty (50) feet above the landing threshold using a standard three (3) degree glidepath. (Emphasis added.)

The FAA Solar Guidelines "requires the use of the Solar Glare Hazard Analysis Tool (SGHAT) to demonstrate compliance with the standards for measuring ocular impact stated above for any proposed solar energy system." (*Ibid.*) The project glare analysis used SGHAT.

3. How does this project compare to glare evaluations conducted for projects within other airport influence areas where studies have been performed and no impacts resulted?

The studies that I have performed on solar facilities with single-axis trackers and in close proximity to airports showed no glare to ATCTs or pilots. There are PV systems installed on airports throughout the world, including several notable examples of large-scale ground-mounted PV systems installed at some of the largest airports in the country. For example, Denver and Indianapolis International Airports incorporate large PV systems directly underneath or just offset from aviation runways. The FAA found there were no glare impacts from these systems, which have continued to operate without any issues.

There are also countless solar arrays located on land near airports and in closer proximity to runways than the project. As depicted below, the FAA has provided case studies evaluating PV systems in close proximity and directly underneath flight pathways in California, including the Fresno Yosemite and Metropolitan Oakland International Airports.

Fresno Yosemite International Airport (FYI) – California

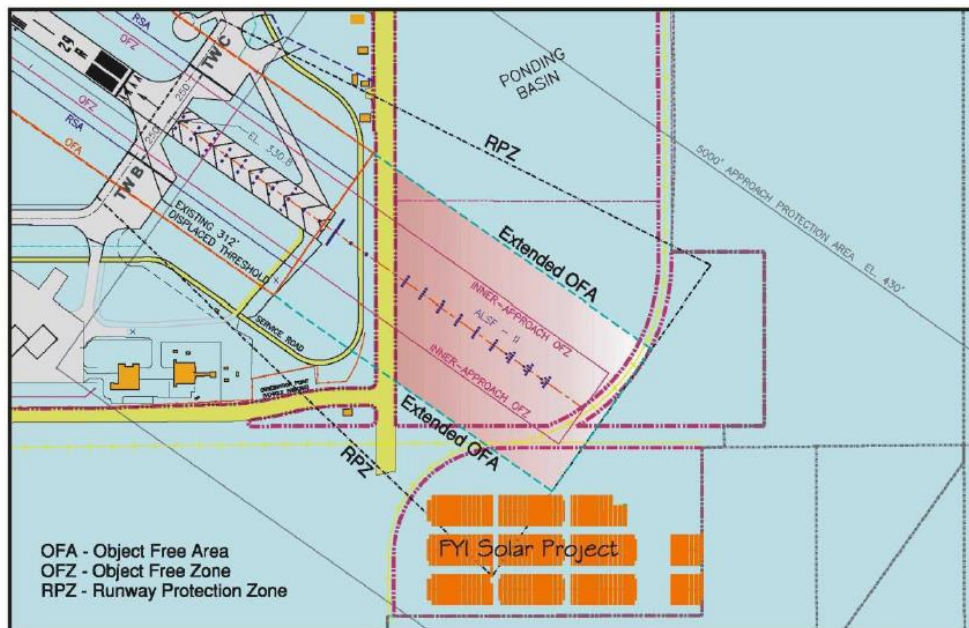

The City of Fresno constructed a 2.4 MW ground-mounted solar generation system in June 2008. The project consists of 11,700 solar panels on a single axis tracking system, which are located near the end of Runway 29. Specifically, the site is adjacent to the Object Free Area and inside a portion of the Runway Protection Zone. There have been no glare issues associated with this project.

Metropolitan Oakland International Airport – California



Oakland International's Airport is host to a 756 kW ground-mounted system, developed in 2007. The panels are located approximately 400 feet from the runway. The project has been operational since November 2007 and there have been no reports of airspace impacts from radar or glare on the air traffic control tower or on pilots.

4. Does an ILS vs. visual approach/departure affect the analysis?

No, the analysis methodology and acceptance criteria are the same regardless of instrument or visual approach. Further, the analysis methodology and acceptance criteria were developed to account for the potential glare impact to a wide range of aircraft and airports.

5. Why are the 6 flight tracks modeled in the analysis fully representative of all potentially significant glare occurrences within the flight pattern? It appears modeling only evaluated the straight-in approach on a single elevation glide path. What about departure paths, circling to land patterns, characteristics of the various aircraft making overflight – speed, elevation, proximity to the overflight, vulnerability/recoverability in the pattern for various aircraft types.

The 6 flight tracks modeled were chosen based on the requirements set forth in the FAA Solar Guidelines. As provided above, the FAA Solar Guidelines specifically states that the assessment criteria for pilot impact is limited to the final approach path, with the final approach path defined as "a straight path two (2) miles from fifty (50) feet above the landing threshold using a standard three (3) degree glidepath."

The FAA report entitled *Evaluation of Glare as a Hazard for General Aviation Pilots on Final Approach* presents research on the potential for glare at various locations during various portions of a flight to create a hazard for a pilot. Based on various studies, including personal interview with various pilots throughout the country, the FAA determined that the final approach is the only area of flight where solar panel glare could impair a pilot's ability to fly. Specifically, a pilot's ability to fly was only impaired on the final approach when the glare is straight ahead and for more than five seconds. (See FAA, *Evaluation of Glare as a Hazard for General Aviation Pilots on Final Approach*, p. 9 (July 2015).)

6. Are helicopters potentially impacted?

While the FAA Solar Guidelines do not address helicopters, this is an indication that the risk for glare impact to helicopters is dramatically lower than the risk of glare to airplane pilots. Helicopters have a slow approach speed and can change approach angles and speeds, which mitigates the potential for impact from solar glare or glare of any kind for that matter.

7. Why is the modeling evaluation period 1 minute? It is possible that glare could occur for less than one minute and the model isn't capturing that?

The FAA Solar Guidelines state: "Ocular impact must be analyzed over the entire calendar year in one (1) minute intervals from when the sun rises above the horizon until the sun sets below the horizon." As the sun slowly moves across the sky it is not possible that there is a glare-producing solar position between two non-glare-producing positions one minute apart.

8. Do the seasonal changes in sun angle (summer tracking more overhead, winter tracking more toward the south) create a potential for glare at some point during the year relative to various applicable flight patterns even for single-axis tracking systems?

The software model is able to accurately model the solar radiation angles and the appropriate PV panel reflectivity. While it is theoretically possible for there to be some glare from a single-axis tracking, the SGHAT analysis of the project did not find any glare at any minute of the year, regardless of the season. Any glare created from a single-axis tracking system would be of a low intensity that would not have any impacts for pilots on their final approach. It is much more likely that pilots would experience glare from nearby waterbodies during any season of the year compared with the project. I am not aware of any safety incidents at the Napa County Airport related to the waterbodies nearby.

9. Study says that severe glare earlier in the flight pattern is generally not a hazard. What is the basis or criteria for this determination? It seems that any severe glare to pilots is a hazard.

The FAA made this determination, which was based on FAA and national laboratory studies and reports on the potential for solar glare impacts on pilots. Those reports include *Evaluation of Glare as a Hazard for General Aviation Pilots on Final Approach*, which presents research on the potential for glare at various locations during various portions of a flight pattern to create a hazard for pilots. The report concluded that solar glare only creates meaningful risk (i.e. a safety hazard) during the final approach portion of a flight. Any glare earlier in the flight pattern does not create a safety hazard. The FAA's conclusions have been confirmed by several interviews I have had with pilots.

It is very common for pilots to experience intense glare from water surfaces or direct viewing of the sun during a flight, both of which are much more intense than the worst possible glare from a PV facility. Because aircraft typically travel at a higher rate of speed than vehicles, the effect is momentary, lasting only as long as the angle between the sun, water body, and aircraft is maintained.

As noted above, it is much more likely that pilots would be impacted by glare from nearby waterbodies during any season of the year compared with the project. I am not aware of any safety incidents at the Napa County Airport due to glare from the waterbodies nearby. Further, I am not aware of any safety incidents at the Napa County Airport due to any of the fixed solar panels on the adjacent industrial buildings.

Glare Impact Study of Soscol Ferry Solar Facility



Thomas Cleveland, PE
Raleigh, NC
July 31, 2019

Table of Contents

Executive Summary.....	2
Background	3
Glare Impact Analysis.....	3
Modeling the Soscol Ferry Solar Facility	3
Analysis of the Napa County Airport (KAPC).....	6
Analysis of Potential Glare Impacts to Nearby Motorists.....	8
Analysis of Residential and Commercial/Industrial Neighbors.....	12
SGHAT Results.....	13
Conclusion.....	14
Appendix A: SGHAT/ForgeSolar Results Report.....	15
Appendix B: SGHAT/ForgeSolar Results Report for Sunrise Backtrack Simulation.....	30
Appendix C: SGHAT/ForgeSolar Results Report for Sunset Backtrack Simulation.....	41
Appendix D: Thomas Cleveland’s CV	50



Executive Summary

Photovoltaic (PV) modules (aka solar panels) are designed to absorb, and thus not reflect, close to 100% of the solar energy that strikes them. However, when sunlight strikes the glass front of a solar panel at a glancing angle a significant portion of the solar radiation is reflected, which can potentially lead to solar glint or glare impacting a person's vision, including pilots landing aircraft. Thankfully, the conditions required for a PV project to create hazardous glare rarely occur. Also, it is possible to use specialized 3-D modeling software to predict when and where glare may be produced, which allows adjustment of solar project designs before they are constructed in order to avoid the potential for glare hazards.

To avoid construction of solar PV projects that could create a solar glare hazard for aircraft, the Federal Aviation Administration (FAA) and the US Department of Energy's Sandia National Laboratories partnered to develop a software to calculate the potential for a PV project to create glare intense enough to be a hazard to nearby aviation. The software, called Solar Glare Hazard Analysis Tool (SGHAT), may also be used to assess the potential for a PV project to cause solar glare for other viewers, such as vehicle drivers on nearby roads and neighbors looking out of their windows.

The analysis presented in this report used a privately licensed version of the SGHAT software, called ForgeSolar, to conduct a detailed site-specific PV solar glare analysis of the proposed Soscol Ferry Road Solar project (Project). The software from ForgeSolar has been validated as effective for this type of solar glare analysis. The software analysis checks for the potential for solar glare of any intensity for every minute of the year at many user-defined observation points and/or routes. Specifically, the analysis of the Soscol Ferry Solar project included the final approach flight paths for the six runways at Napa County Airport (KAPC), the air traffic control tower at Napa County Airport, a 3-mile section of Hwy 12, Soscol Ferry Road, $\frac{3}{4}$ of a mile of Napa Valley Corporate Dr., and buildings within 1 mile of the site (see figure to the right for locations as modeled in ForgeSolar).

The analysis predicts **no glare** of any intensity at any time during the year at any of the analyzed observation locations.

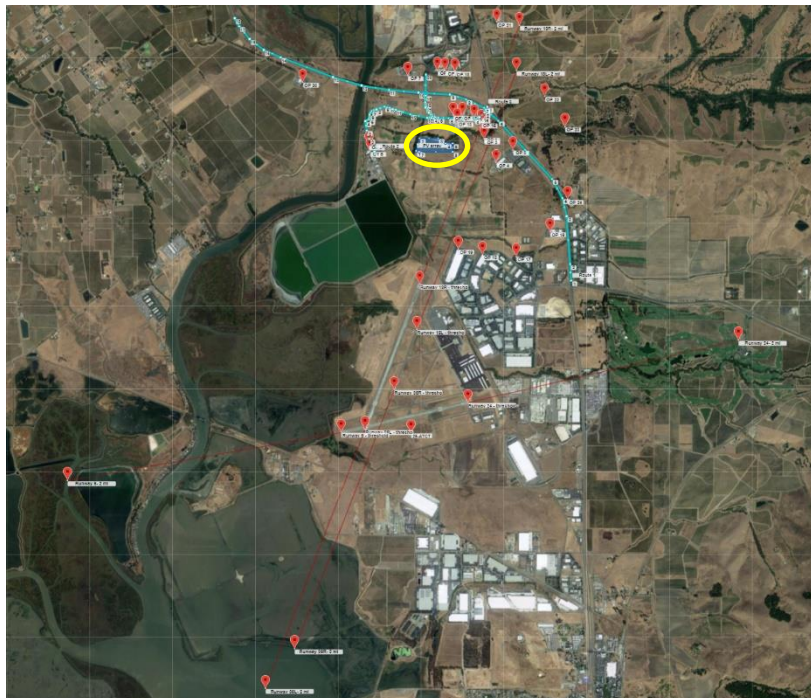

Napa County Airport in Center (red lines); Hwy 12, Soscol Ferry Road, and Napa County Corporate Dr. 2-way routes (aqua lines); and Buildings (red OP# markers) [PV site circled in yellow]

Background

At the request of RP Napa Solar 2, LLC, I conducted an analysis of the potential for solar glare impacts by the proposed 1.98 MW_{AC} Soscol Ferry Solar facility located about 4 miles south of downtown Napa, California. The study analyzed the potential for glare impacts to drivers on all nearby roads, pilots and air traffic controllers at Napa County Airport, and residential and commercial/industrial neighbors within one mile.

Glare Impact Analysis

Intense glare can create a visual hazard. Every experienced driver is familiar with the type of glare shown in the photo to the right that occurs when an auto driver is heading directly into the rising or setting sun. Similarly, airplane and helicopter pilots often fly in the direction of the sun and thus experience very intense glare directly from the sun itself. Pilots also experience glare from reflections off a variety of objects on the ground, such as metal structures, bodies of water, and car windshields. Consequently, pilots fly with sunglasses and tinted visors to minimize



Figure 1: Glare coming directly from the Sun

this hazard. The reflected glare produced by these objects is not nearly as intense as direct sunlight, but they can be intense enough to have a hazardous impact on vision. Like many other objects on or near the ground, solar panels (aka PV modules) can reflect sunlight and cause glare visible to pilots. There is also the potential for solar panels on or very near the airport to cause distracting glare for air traffic controllers. Due to these potential hazards, the Federal Aviation Administration (FAA) and the US Department of Energy's Sandia National Laboratories collaborated to create an online software tool, known as the Solar Glare Hazard Analysis Tool, or SGHAT, to analyze solar photovoltaic projects for their potential to create hazardous solar glare. After multiple years of free public availability, access to the SGHAT tool was ended in 2017 and the SGHAT technology was licensed to a private company, ForgeSolar. ForgeSolar improved upon the original SGHAT technology and offers a private solar glare hazard analysis tool, which is the only such tool available today. The analysis presented in this report used the current professional ForgeSolar software.

The software calculates the potential for glare at each modeled observer (e.g., approaching pilot, passing motorist, neighbor) for every minute of the year. The model knows the position of the sun each minute, assumes a cloud-free sky, and calculates the potential for glare from each section of the proposed solar facility. The software can calculate not only whether there is a possibility for glare each minute, but also the intensity of the glare. Thus, it can assess the degree of hazard any glare may present to pilots and motorists.

Modeling the Soscol Ferry Solar Facility

The models presented in this report use the default SGHAT values for model variables that are not site specific, such as the sun subtended angle of 9.3 milliradians and 0.017 meter eye focal length. All the model variables are visible in the ForgeSolar results reports included in Appendix A of this report.

Figure 2 shows the location of the PV array modeled in the ForgeSolar. The modeled array covers the entire parcel on which the Project is located in order to assess the potential glare impact of a PV array located anywhere on the parcel. A satellite image of the site area containing an outline of the parcel was overlaid over the ForgeSolar software so that the PV array location in the model accurately represents the location of the Project. To be conservative the array in ForgeSolar extends to the site's perimeter fence.



Figure 2. Soscol Ferry Solar PV Array in ForgeSolar (blue area with numbered vertices) with Overlay of the Parcel Outline (yellow line) of the Entire Parcel on which the Soscol Ferry Solar Site is Located

The entire project uses single-axis tracking raking to mount the PV modules. As is typical for this type of PV module racking, the array at the Soscol Ferry site consists of 1-module-wide rows that are each oriented along a North-South line. This North-South line is also the axis of rotation of each row. The basic motion is that each row slowly rotates over the course of every day from a 60-degree tilt toward the east at sunrise to a 60-degree tilt toward the west by sunset. Around midday when the sun is at its highest position in the sky the rows of modules are horizontal, with each module facing straight up. The ForgeSolar analysis assumes that the rows remain tilted 60 degrees to the west from the time of sunset each day until the time of sunrise the next day. In actuality the tracking system is likely to be more sophisticated and implement automatic backtracking, which means that near sunrise and sunset the rows will tilt less than the full 60 degrees in order to avoid each row partially shading the row behind it.

Solar module electricity production is very sensitive to partial shading, so the system can produce more power by facing the modules a little more horizontal than otherwise optimal if it means avoiding one row shading another. This backtracking will increase the incidence angle of the sunlight on the modules which increases the reflectivity of the modules and thus the potential for glare impacts. Unfortunately, the ForgeSolar software is not currently able to model automatic backtracking, however additional ForgeSolar simulations were conducted to assess the glare impact of backtracking. Four additional ForgeSolar simulations were conducted, two with the PV array facing west with fixed-tilts of 45 and 30 degrees from

horizontal, and another two facing east also with tilts of 45 and 30 degrees. The west-facing models represent a backtracked array near sunset and the east-facing models represent a backtracked array near sunrise. The only portion of the SGHAT results from the fixed-tilt array models that is meaningful is the time period near sunrise (for the east-facing arrays) or sunset (for the west-facing arrays).

For all SGHAT models in this report, the solar array is modeled at a height of 5 feet, representing a typical height for the center of each PV module. Models were also run with array heights of 2 feet and 8 feet, representing the bottom and top of the array, as recommended in the SGHAT user manual. The results of the 2-ft and 8-ft height models were exactly the same as the model with a 5-foot array height, so for simplicity only the 5-foot array data is presented in this report.

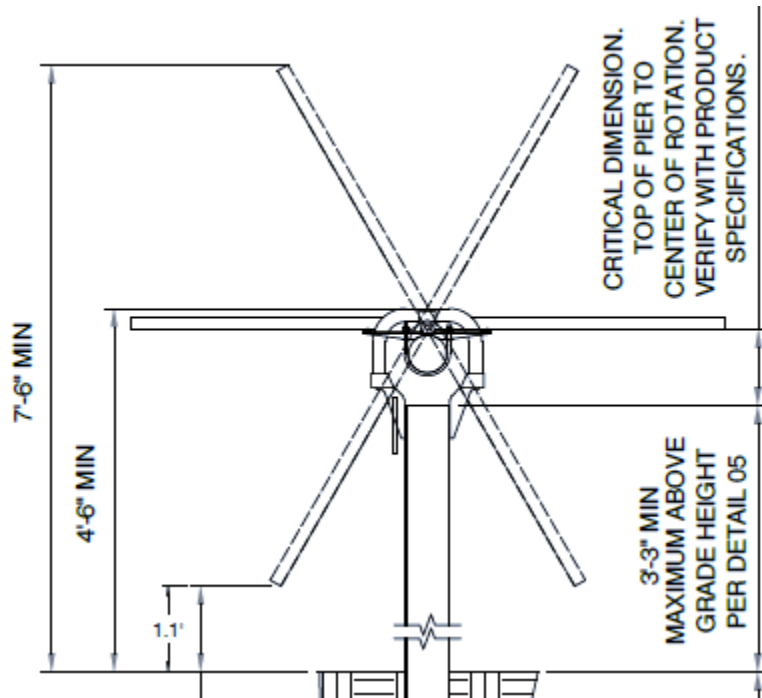

Figure 3. Diagram of PV Module Racking from the Soscol Ferry Solar Site Plan, Including Minimum Height Above Grade For Horizontal and Extreme Angles of Rotation

It is vital to realize that the ForgeSolar software does not take into account visual obstructions between the solar array and the observer. This includes both topographical barriers, such as a hill, and living or man-made barriers such as a forest or building. A comprehensive analysis of the visibility of the solar array from each observation route or point is not included in this report, although aerial 3D surface models show that the buildings to the north of Hwy 12 do not have a view of the solar array, and thus any glare it may produce, due to Hwy 12 being elevated on a berm 50-75 taller than the flat land on either side. For simplicity, no relevant observation points were omitted from the ForgeSolar analysis due to having its line of sight to the array blocked. However, some potential building observation points were omitted from the ForgeSolar analysis due to other building blocking their sight of the array and/or because other modeled observation points represent a closer observation point along the same or similar line of sight.

Analysis of the Napa County Airport (KAPC)

This analysis modeled the potential for glare hazards for Napa County Airport (KAPC), which is located about 1.0 mile south of the Soscol Ferry Solar project (measured from the threshold of the closest runway to the closest solar module). The Napa County Airport Land Use Compatibility Plan classifies all the land around the base as one of several impact zones (Zones A to E) depending on its potential to impact operations at the base with Zone A having the most potential for impact. The proposed site for the Soscol Ferry PV project is in Zone C (approach path) of the Napa County Airport Land Use Compatibility Use Plan, which requires that any development not produce a hazard to aircraft in flight. Based on the FAA guidance on glare impacts, to comply with this requirement the solar project must not create glare along any final approach path that is more intense than glare that has a “low potential for after-image”. Napa County Airport has six runways: Runway 18R/36L, Runway 6/24, and a shorter, narrower strip Runway 36R/18L. Each set of runways share the same physical runway but represent approaches from opposite ends. The specifics of the typical approach for each runway were set based on FAA data for Napa County Airport¹. The airport also has an air traffic control tower located just to the south of the runways that was included in the solar glare analysis as Observation Point 25.

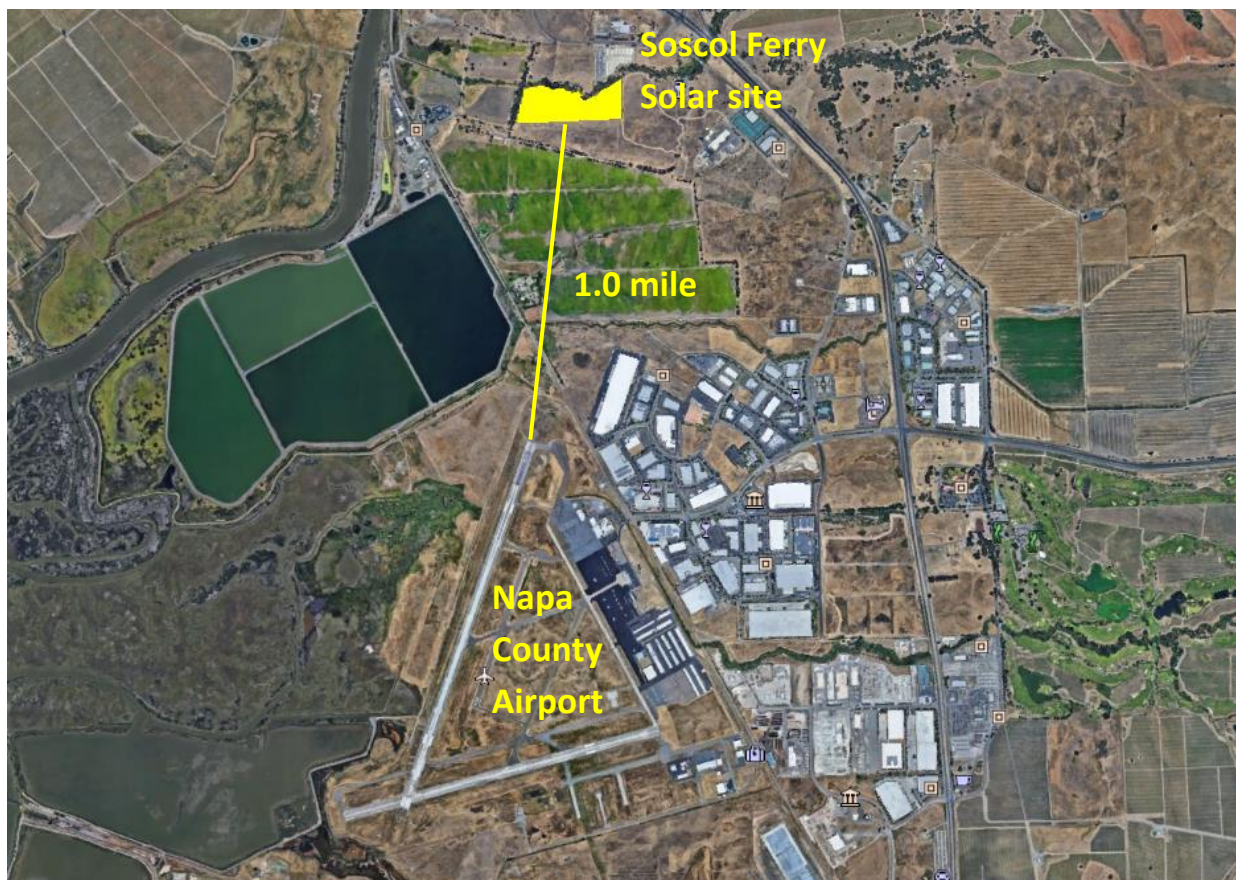

Figure 4. Location of Napa County Airport in Relation to the Soscol Ferry Solar Project Site; 1.0 Miles Between Them Along the Yellow Line (Image is Oriented with North Toward the Top)

¹ Sourced from <http://maps.avnwx.com/airport/KAPC> which presents the current airport data provided by FAA (https://aeronav.faa.gov/afd/20jun2019/sw_172_20JUN2019.pdf) in a user-friendly format



Figure 5. Approach Flight Paths (Red Lines) to Napa County Airport’s Six Runways and Air Traffic Control Tower (“25 – ATCT” just south of the center of runway 6/24) as Modeled in ForgeSolar

As specified in the Interim Policy for the FAA Review of Solar Energy System Projects on Federally Obligated Airports², the ForgeSolar software examines the last two miles of the landing approach to each runway. The analysis is limited to this portion of the flight path because severe glare during the final approach has the potential to create a hazard for the pilot, whereas severe glare earlier in the flight is generally not a hazard.

The SGHAT airport results were **no glare** of any intensity during any minute of the year for any of the flight paths and for the air traffic control tower. The four additional ForgeSolar models representing intelligent backtracking of the array near sunrise and sunset predicted **no glare** from a backtracking array.

² “Interim Policy for the FAA Review of Solar Energy System Projects on Federally Obligated Airports.”, <http://www.gpo.gov/fdsys/pkg/FR-2013-10-23/pdf/2013-24729.pdf>

Analysis of Potential Glare Impacts to Nearby Motorists

The proposed project is over 250 yards from the closest public road, Soscol Ferry Road, but does have several roads nearby. So, the three roads (Hwy 12, Soscol Ferry Road, and Napa Valley Corporate Dr.) in the vicinity of the proposed solar project were included in the ForgeSolar analysis. Soscol Ferry Road is the closest road to the site, but its views of the site are nearly fully blocked by a row of heavy vegetation. Napa Valley Corporate Drive is a U-shaped road to the north of the site and its views of the site are also well buffered by the vegetation to the north of the solar site. Hwy 12 is about 1/3 of a mile to the north and east of the site and has some views of the site as it approaches from the east. Despite the very limited views of the solar site, the full lengths of the nearby roads were included in the solar glare hazard analysis to make the analysis as simple and conservative as possible. The following few images from a 3D model of the site in Google Earth use elevated views from above the area to provide a sense of the views of the site for motorists on the nearby roadways. The yellow area seen in these images is the site footprint within the project's perimeter fence.



Figure 6. View from Southeast of the Project site from an Elevated Viewpoint across Hwy 12; The Yellow Area is the Project site Footprint within the Perimeter Fence.



Figure 7. View from an Elevated Viewpoint North of Hwy 12 above Napa Valley Corporate Drive



Figure 8. View from an Elevated Viewpoint Northwest of the Site, Above Soscol Ferry Road

ForgeSolar provides a “route” type of observation location that is designed to model the potential for glare hazards along roads and other routes. Three route was modeled in ForgeSolar as shown in Figure

9, Figure 10Figure 11, which are each analyzed by ForgeSolar for motorists traveling in both directions. The routes were modeled at 3.5 feet above the ground, to represent the height of a driver, per the American Association of State Highway and Transportation Officials (AASHTO) eye height of a driver of a passenger vehicle³. The software checks for glare from up to 50 degrees from the direction of travel. Studies of pilots have shown that glare from beyond 45 degrees from their direction of travel does not present any glare hazard, and it is reasonable to assume that the same holds true for motor vehicle drivers as well.

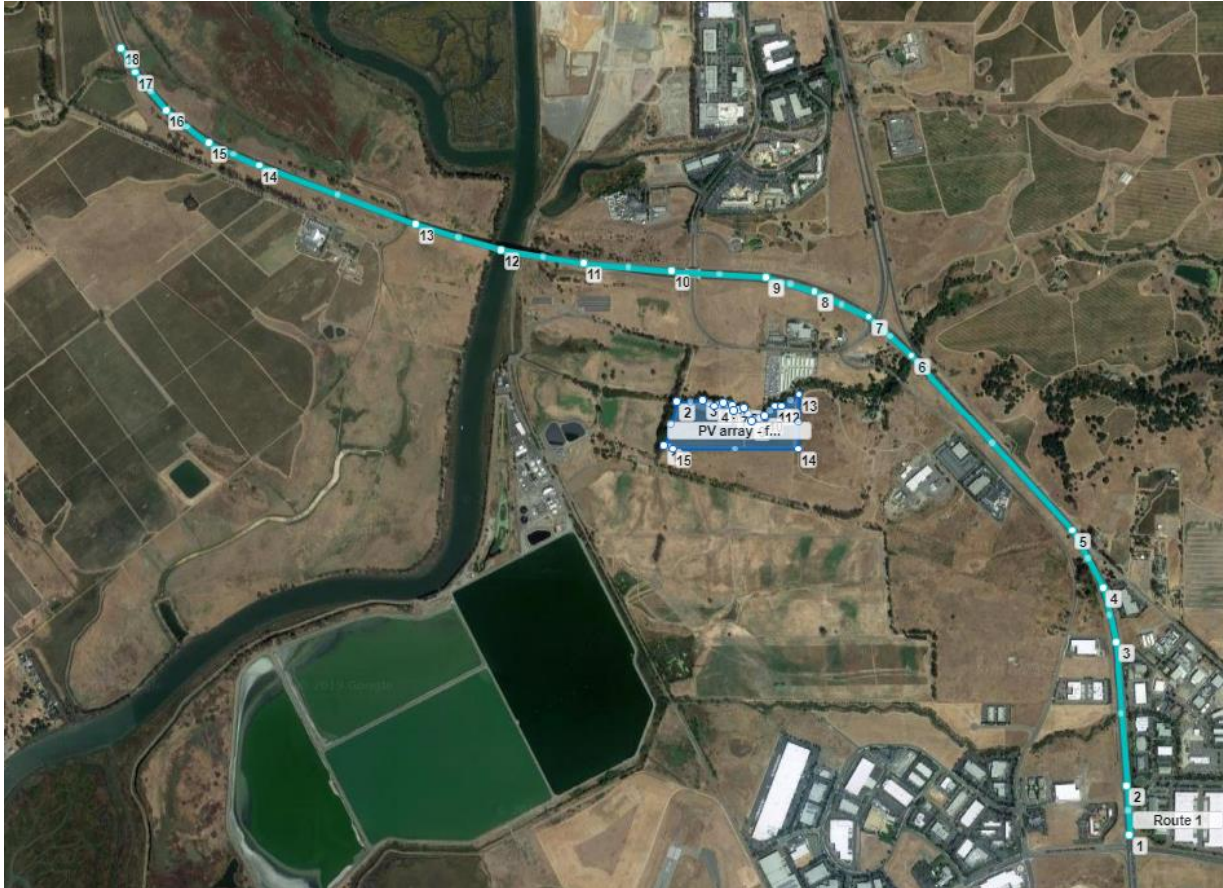

Figure 9. Observation Route (Route 1) on Hwy 12 as Modeled in ForgeSolar, Over 3 Miles End-to-End

³ A Policy on Geometric Design of Highways and Streets. American Association of State Highway and Transportation Officials, Washington, D. C., 2004 edition



Figure 10. Observation Route (Route 2) on Soscol Ferry Road and Napa Valley Corporate Drive as Modeled in ForgeSolar, Over 1 Mile End-to-End



Figure 11. Observation Route (Route 3) on Napa Valley Corporate Drive as Modeled in ForgeSolar, Close to ½ Mile End-to-End

The SGHAT motorist results were **no glare** of any intensity during any minute of the year for motorists on Hwy 12, Soscol Ferry Road, or Napa Valley Corporate Drive. The four additional ForgeSolar models representing intelligent backtracking of the array near sunrise and sunset predicted **no glare** from a backtracking array for motorists on these roadways.

Analysis of Residential and Commercial/Industrial Neighbors

The closest buildings to the project site are nearly a ¼ of a mile from the site fence. There are numerous residential, industrial, and commercial buildings between about 1/4 and 1 mile from the PV site. Twenty-four of these buildings were included in the ForgeSolar model (Observation Points 1 through 24. Observation Point 25 is the air traffic control tower at Napa County Airport). There are additional buildings within a 1-mile radius of the solar facility that are not included in the ForgeSolar model, but these buildings are either unoccupied, have their view blocked by a building included in the analysis, or their potential for glare is represented by the analysis results of a nearby building included in the analysis. Most of the buildings have their view of the solar project at least partially blocked by either a hill between the building and the site or heavy vegetation. The buildings north of Hwy 12 have their view of the solar site fully blocked by the berm that elevates this portion of Hwy 12. Rather than include a line-of-site study to justify not modeling some buildings, all appropriate buildings (with the limitations listed above) were simply included in the ForgeSolar analysis.

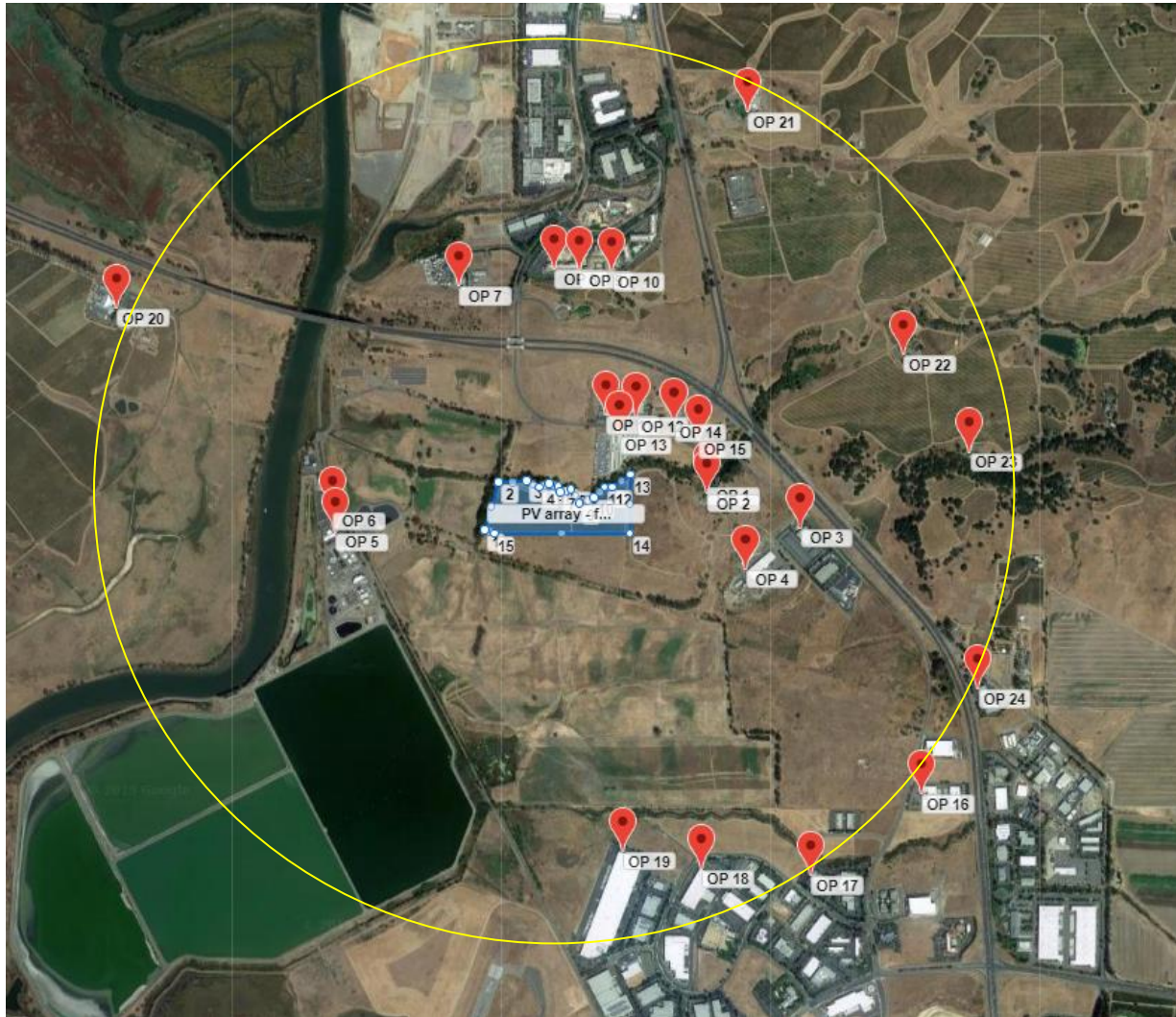

Figure 12. Building Observation Points (OP 1 to OP 24) at Residential and Commercial/Industrial Buildings within 1 Mile Radius (Yellow Circle) of the Center of the Proposed Solar Facility as Modeled in ForgeSolar

The SGHAT building glare results were **no glare** of any intensity during any minute of the year for any of the observation points located at buildings. The four additional ForgeSolar models representing intelligent backtracking of the array near sunrise and sunset predicted **no glare** from a backtracking array for any of the observation points located at buildings.

SGHAT Results

As described above, the ForgeSolar SGHAT software was used to conduct a glare hazard analysis of pilots landing at Napa County Airport; air traffic controllers at Napa County Airport; motorists on Soscol Ferry Road, Napa County Corporate Drive, and Hwy 12; and people at nearby buildings. A summary of results is presented in this section of the report and the full ForgeSolar-generated report is provided in Appendix A.

The ForgeSolar SGHAT defines two intensities of glare, “green” and “yellow”. Green glare represents a “Low Potential for Temporary After-Image” and is about 1/1000th the intensity of looking directly into the sun (based on Hazards Plot in the SGHAT User’s Manual)⁴. According to the FAA Interim solar policy⁵, which defines the requirements for solar projects constructed on airport property, glare visible to pilots on their final landing approach that is classified in this green range is acceptable. In other words, any amount of green glare is considered non-hazardous. Yellow glare has a “Potential for Temporary After-Image”; such glare could affect the pilot’s ability to see clearly even after looking away from the glare. The FAA Interim solar policy (which only has authority for solar built on airports) does not allow solar arrays that produce yellow glare visible to pilots on final approach to be built on airport property. The ForgeSolar results use the same green and yellow glare classifications for glare visible at other types of observation points as well, such as to motorists and pedestrians.

The ForgeSolar SGHAT results were **no glare** of any intensity during any minute of the year for every flight path, air traffic control tower, roadway route, and land-based observation point. As described in the *Modeling the Soscol Ferry Road Solar Facility* section, additional ForgeSolar models were constructed to simulate intelligent backtracking by the tracking system early and late in the day to avoid inter-row shading. When backtracking the PV modules are turned slightly away from the sun and thus have more potential to create a glare hazard. The results of these simulations showed that backtracked rows (45 and 30 degrees from horizontal) did not produce any glare during the hours near sunrise and sunset in which backtracking may be used. The models did predict some glare near noon, but this glare result is meaningless because the array will be tracking the sun at this time of day and will not be in a backtracked position at that time. The ForgeSolar-generated reports for the 30-degree fixed-tilt east-facing and west-facing are provided in Appendix B and Appendix C respectively. The 45-degree tilt results were similar to the 30-degree results and thus not included in the report.

⁴ *Solar Glare Hazard Analysis Tool Users Manual version 2.0*,
https://share.sandia.gov/phlux/static/references/glint-glare/SGHAT_Users_Manual_v2-0_final.pdf

⁵ *Interim Policy for the FAA Review of Solar Energy System Projects on Federally Obligated Airports*,
<http://www.gpo.gov/fdsys/pkg/FR-2013-10-23/pdf/2013-24729.pdf>

Conclusion

The solar glare hazard analysis of the proposed Soscol Ferry Road Solar facility finds that the PV system will not produce any glare hazards. ForgeSolar, a detailed, proven solar glare hazard analysis software, was used to model the potential for the proposed solar array to cause glare for approaching motorists, people at nearby buildings, and pilots and air traffic controllers at Napa County Airport. In fact, the software analysis found **no glare of any intensity at any time during the year at any of the analyzed locations**. The proposed PV project uses a single-axis tracking racking system to support the solar modules/panels which keeps the solar modules facing generally toward the sun. This design avoids situations where the sunlight hits the solar panels with a glancing angle, which is the only condition when the glass of a solar panel is very reflective and thus the only condition likely to cause visible glare to an observer.



Appendix A: SGHAT/ForgeSolar Results Report

ForgeSolar Glare Analysis Report – Page 1 of 15



FORGESOLAR GLARE ANALYSIS

Project: **Soscol Ferry**

A proposed 2 MW PV facility on Soscol Ferry Rd. in Napa, California. The array is single-axis tracking.

Site configuration: **baseline of full parcel area**

Analysis conducted by Tommy Cleveland (thcleveland@gmail.com) at 03:43 on 31 Jul, 2019.

U.S. FAA 2013 Policy Adherence

The following table summarizes the policy adherence of the glare analysis based on the 2013 U.S. Federal Aviation Administration Interim Policy 78 FR 63276. This policy requires the following criteria be met for solar energy systems on airport property:

- No "yellow" glare (potential for after-image) for any flight path from threshold to 2 miles
- No glare of any kind for Air Traffic Control Tower(s) ("ATCT") at cab height.
- Default analysis and observer characteristics (see list below)

ForgeSolar does not represent or speak officially for the FAA and cannot approve or deny projects. Results are informational only.

COMPONENT	STATUS	DESCRIPTION
Analysis parameters	PASS	Analysis time interval and eye characteristics used are acceptable
Flight path(s)	PASS	Flight path receptor(s) do not receive yellow glare
ATCT(s)	PASS	Receptor(s) marked as ATCT do not receive glare

Default glare analysis parameters and observer eye characteristics (for reference only):

- Analysis time interval: 1 minute
- Ocular transmission coefficient: 0.5
- Pupil diameter: 0.002 meters
- Eye focal length: 0.017 meters
- Sun subtended angle: 9.3 milliradians

FAA Policy 78 FR 63276 can be read at <https://www.federalregister.gov/d/2013-24729>

SITE CONFIGURATION

Analysis Parameters

DNI: peaks at 1,000.0 W/m²
 Time interval: 1 min
 Ocular transmission coefficient: 0.5
 Pupil diameter: 0.002 m
 Eye focal length: 0.017 m
 Sun subtended angle: 9.3 mrad
 Site Config ID: 29959.5354



PV Array(s)

Name: PV array - full parcel area
Axis tracking: Single-axis rotation
Tracking axis orientation: 180.0°
Tracking axis tilt: 0.0°
Tracking axis panel offset: 0.0°
Max tracking angle: 60.0°
Resting angle: 60.0°
Rated power: 1980.0 kW
Panel material: Smooth glass without AR coating
Reflectivity: Vary with sun
Slope error: correlate with material



Vertex	Latitude (")	Longitude (")	Ground elevation (ft)	Height above ground (ft)	Total elevation (ft)
1	38.237104	-122.278527	25.01	5.00	30.01
2	38.238651	-122.277958	21.79	5.00	26.80
3	38.238672	-122.276784	24.58	5.00	29.58
4	38.238490	-122.276295	26.05	5.00	31.05
5	38.238583	-122.275909	26.42	5.00	31.42
6	38.238511	-122.275534	25.23	5.00	30.23
7	38.238330	-122.275410	29.51	5.00	34.51
8	38.238427	-122.274961	28.15	5.00	33.15
9	38.237976	-122.274659	34.12	5.00	39.12
10	38.238132	-122.274064	42.34	5.00	47.34
11	38.238490	-122.273619	38.53	5.00	43.53
12	38.238474	-122.273345	45.58	5.00	50.58
13	38.238878	-122.272556	47.27	5.00	52.27
14	38.236986	-122.272610	45.63	5.00	50.64
15	38.237007	-122.278119	26.08	5.00	31.08

Flight Path Receptor(s)

Name: Runway 18L
Description:
Threshold height: 50 ft
Direction: 201.0°
Glide slope: 3.0°
Pilot view restricted? Yes
Vertical view: 30.0°
Azimuthal view: 50.0°



Point	Latitude (°)	Longitude (°)	Ground elevation (ft)	Height above ground (ft)	Total elevation (ft)
Threshold	38.218450	-122.278381	21.13	50.00	71.14
Two-mile	38.245442	-122.265178	111.30	513.29	624.59

Name: Runway 18R
Description:
Threshold height: 52 ft
Direction: 201.0°
Glide slope: 3.0°
Pilot view restricted? Yes
Vertical view: 30.0°
Azimuthal view: 50.0°

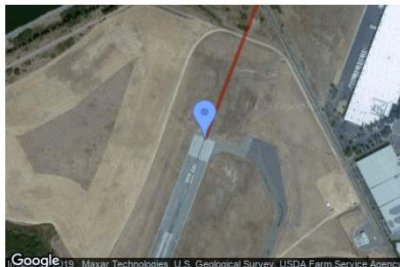

Point	Latitude (°)	Longitude (°)	Ground elevation (ft)	Height above ground (ft)	Total elevation (ft)
Threshold	38.223162	-122.278005	29.12	52.00	81.13
Two-mile	38.250155	-122.264800	131.38	503.21	634.58

ForgeSolar Glare Analysis Report – Page 4 of 15

Name: Runway 24
Description:
Threshold height: 50 ft
Direction: 257.0°
Glide slope: 3.0°
Pilot view restricted? Yes
Vertical view: 30.0°
Azimuthal view: 50.0°



Point	Latitude (°)	Longitude (°)	Ground elevation (ft)	Height above ground (ft)	Total elevation (ft)
Threshold	38.210852	-122.271618	35.66	50.00	85.66
Two-mile	38.217356	-122.235722	157.07	482.04	639.11

Name: Runway 36L
Description:
Threshold height: 50 ft
Direction: 21.0°
Glide slope: 3.0°
Pilot view restricted? Yes
Vertical view: 30.0°
Azimuthal view: 50.0°



Point	Latitude (°)	Longitude (°)	Ground elevation (ft)	Height above ground (ft)	Total elevation (ft)
Threshold	38.208032	-122.285264	14.27	50.00	64.27
Two-mile	38.181040	-122.298466	2.17	615.56	617.73

Name: Runway 36R
Description:
Threshold height: 50 ft
Direction: 21.0°
Glide slope: 3.0°
Pilot view restricted? Yes
Vertical view: 30.0°
Azimuthal view: 50.0°



Point	Latitude (°)	Longitude (°)	Ground elevation (ft)	Height above ground (ft)	Total elevation (ft)
Threshold	38.212176	-122.281407	13.28	50.00	63.28
Two-mile	38.185186	-122.294609	2.58	614.16	616.74

ForgeSolar Glare Analysis Report – Page 5 of 15

Name: Runway 6
Description:
Threshold height: 50 ft
Direction: 80.0°
Glide slope: 3.0°
Pilot view restricted? Yes
Vertical view: 30.0°
Azimuthal view: 50.0°



Point	Latitude (°)	Longitude (°)	Ground elevation (ft)	Height above ground (ft)	Total elevation (ft)
Threshold	38.207728	-122.288439	13.93	50.00	63.93
Two-mile	38.202707	-122.324718	4.48	612.90	617.38



ForgeSolar Glare Analysis Report – Page 6 of 15

Discrete Observation Receptors

Name	ID	Latitude (°)	Longitude (°)	Elevation (ft)	Height (ft)
OP 1	1	38.238531	-122.269469	66.04	6.00
OP 2	2	38.238271	-122.269454	65.27	6.00
OP 3	3	38.237167	-122.265653	61.21	6.00
OP 4	4	38.235844	-122.267874	54.88	6.00
OP 5	5	38.237030	-122.284632	16.46	6.00
OP 6	6	38.237717	-122.284761	12.92	6.00
OP 7	7	38.244907	-122.279598	29.05	6.00
OP 8	8	38.245461	-122.275703	32.79	6.00
OP 9	9	38.245427	-122.274651	30.34	6.00
OP 10	10	38.245368	-122.273343	31.57	6.00
OP 11	11	38.240774	-122.273588	49.35	6.00
OP 12	12	38.240728	-122.272357	53.53	6.00
OP 13	13	38.240128	-122.273030	43.38	6.00
OP 14	14	38.240546	-122.270788	60.17	6.00
OP 15	15	38.240015	-122.269790	60.68	6.00
OP 16	16	38.228644	-122.260730	57.37	6.00
OP 17	17	38.226031	-122.265236	41.93	6.00
OP 18	18	38.226250	-122.269699	41.50	6.00
OP 19	19	38.226823	-122.272918	24.91	6.00
OP 20	20	38.244218	-122.293553	17.13	6.00
OP 21	21	38.250486	-122.267803	58.28	6.00
OP 22	22	38.242743	-122.261441	152.55	6.00
OP 23	23	38.239569	-122.258716	297.97	6.00
OP 24	24	38.232024	-122.258410	76.08	6.00
25-ATCT	25	38.207659	-122.279153	20.73	50.00

Map image of 25-ATCT



Route Receptor(s)

Name: Route 1
 Path type: Two-way
 Observer view angle: 50.0°



Vertex	Latitude (°)	Longitude (°)	Ground elevation (ft)	Height above ground (ft)	Total elevation (ft)
1	38.223573	-122.257910	71.78	3.50	75.28
2	38.225295	-122.258058	67.71	3.50	71.21
3	38.230284	-122.258530	63.04	3.50	66.54
4	38.232189	-122.259088	65.92	3.50	69.42
5	38.234178	-122.260461	71.37	3.50	74.87
6	38.240245	-122.267583	72.47	3.50	75.97
7	38.241576	-122.269452	78.26	3.50	81.76
8	38.242470	-122.271876	87.59	3.50	91.09
9	38.242975	-122.274022	97.61	3.50	101.11
10	38.243161	-122.278164	113.19	3.50	116.69
11	38.243447	-122.282069	127.44	3.50	130.94
12	38.243902	-122.285717	3.20	3.50	6.70
13	38.244795	-122.289493	6.45	3.50	9.95
14	38.246851	-122.296467	18.98	3.50	22.48
15	38.247610	-122.298699	20.68	3.50	24.18
16	38.248755	-122.300587	19.59	3.50	23.09
17	38.250070	-122.301960	20.18	3.50	23.68
18	38.250912	-122.302540	19.07	3.50	22.57



ForgeSolar Glare Analysis Report – Page 8 of 15

Name: Route 2
Path type: Two-way
Observer view angle: 50.0°



Vertex	Latitude (°)	Longitude (°)	Ground elevation (ft)	Height above ground (ft)	Total elevation (ft)
1	38.237033	-122.284001	10.07	3.50	13.57
2	38.238339	-122.284698	5.64	3.50	9.14
3	38.239224	-122.285063	5.00	3.50	8.50
4	38.240210	-122.285224	8.64	3.50	12.14
5	38.240395	-122.284741	12.50	3.50	16.00
6	38.240875	-122.284645	14.69	3.50	18.19
7	38.241255	-122.284419	13.39	3.50	16.89
8	38.241415	-122.283776	15.31	3.50	18.81
9	38.241710	-122.282681	30.24	3.50	33.74
10	38.241600	-122.282016	38.74	3.50	42.24
11	38.241373	-122.281201	41.28	3.50	44.78
12	38.240909	-122.279248	25.36	3.50	28.86
13	38.240547	-122.277006	29.49	3.50	33.00
14	38.240538	-122.276480	34.34	3.50	37.84
15	38.240715	-122.276298	36.39	3.50	39.89
16	38.241095	-122.276802	40.61	3.50	44.11
17	38.241634	-122.277220	52.59	3.50	56.09
18	38.242148	-122.277296	64.06	3.50	67.56
19	38.242864	-122.277231	76.65	3.50	80.15
20	38.245046	-122.277206	56.07	3.50	59.57

Name: Route 3
Path type: Two-way
Observer view angle: 50.0°



Vertex	Latitude (°)	Longitude (°)	Ground elevation (ft)	Height above ground (ft)	Total elevation (ft)
1	38.241686	-122.269042	81.72	3.50	85.22
2	38.241105	-122.269439	72.51	3.50	76.01
3	38.240616	-122.270093	63.08	3.50	66.58
4	38.240422	-122.270758	57.29	3.50	60.79
5	38.240506	-122.274181	42.25	3.50	45.75
6	38.240548	-122.275585	37.13	3.50	40.63
7	38.240717	-122.276316	36.46	3.50	39.96

GLARE ANALYSIS RESULTS

Summary of Glare

PV Array Name	Tilt (°)	Orient (°)	"Green" Glare min	"Yellow" Glare min	Energy kWh
PV array - full parcel area	SA tracking	SA tracking	0	0	6,134,000.0

Total annual glare received by each receptor

Receptor	Annual Green Glare (min)	Annual Yellow Glare (min)
Runway 18L	0	0
Runway 18R	0	0
Runway 24	0	0
Runway 36L	0	0
Runway 36R	0	0
Runway 6	0	0
OP 1	0	0
OP 2	0	0
OP 3	0	0

ForgeSolar Glare Analysis Report – Page 10 of 15

Receptor	Annual Green Glare (min)	Annual Yellow Glare (min)
OP 4	0	0
OP 5	0	0
OP 6	0	0
OP 7	0	0
OP 8	0	0
OP 9	0	0
OP 10	0	0
OP 11	0	0
OP 12	0	0
OP 13	0	0
OP 14	0	0
OP 15	0	0
OP 16	0	0
OP 17	0	0
OP 18	0	0
OP 19	0	0
OP 20	0	0
OP 21	0	0
OP 22	0	0
OP 23	0	0
OP 24	0	0
25-ATCT	0	0
Route 1	0	0
Route 2	0	0
Route 3	0	0

Results for: PV array - full parcel area

Receptor	Green Glare (min)	Yellow Glare (min)
Runway 18L	0	0
Runway 18R	0	0
Runway 24	0	0
Runway 36L	0	0
Runway 36R	0	0
Runway 6	0	0
OP 1	0	0
OP 2	0	0
OP 3	0	0
OP 4	0	0
OP 5	0	0

ForgeSolar Glare Analysis Report – Page 11 of 15

Receptor	Green Glare (min)	Yellow Glare (min)
OP 6	0	0
OP 7	0	0
OP 8	0	0
OP 9	0	0
OP 10	0	0
OP 11	0	0
OP 12	0	0
OP 13	0	0
OP 14	0	0
OP 15	0	0
OP 16	0	0
OP 17	0	0
OP 18	0	0
OP 19	0	0
OP 20	0	0
OP 21	0	0
OP 22	0	0
OP 23	0	0
OP 24	0	0
25-ATCT	0	0
Route 1	0	0
Route 2	0	0

Flight Path: Runway 18L

0 minutes of yellow glare
 0 minutes of green glare

Flight Path: Runway 18R

0 minutes of yellow glare
 0 minutes of green glare

Flight Path: Runway 24

0 minutes of yellow glare
 0 minutes of green glare

Flight Path: Runway 36L

0 minutes of yellow glare
 0 minutes of green glare



ForgeSolar Glare Analysis Report – Page 12 of 15

Flight Path: Runway 36R

0 minutes of yellow glare
0 minutes of green glare

Flight Path: Runway 6

0 minutes of yellow glare
0 minutes of green glare

Point Receptor: OP 1

0 minutes of yellow glare
0 minutes of green glare

Point Receptor: OP 2

0 minutes of yellow glare
0 minutes of green glare

Point Receptor: OP 3

0 minutes of yellow glare
0 minutes of green glare

Point Receptor: OP 4

0 minutes of yellow glare
0 minutes of green glare

Point Receptor: OP 5

0 minutes of yellow glare
0 minutes of green glare

Point Receptor: OP 6

0 minutes of yellow glare
0 minutes of green glare

Point Receptor: OP 7

0 minutes of yellow glare
0 minutes of green glare

Point Receptor: OP 8

0 minutes of yellow glare

ForgeSolar Glare Analysis Report – Page 13 of 15

0 minutes of green glare

Point Receptor: OP 9

0 minutes of yellow glare

0 minutes of green glare

Point Receptor: OP 10

0 minutes of yellow glare

0 minutes of green glare

Point Receptor: OP 11

0 minutes of yellow glare

0 minutes of green glare

Point Receptor: OP 12

0 minutes of yellow glare

0 minutes of green glare

Point Receptor: OP 13

0 minutes of yellow glare

0 minutes of green glare

Point Receptor: OP 14

0 minutes of yellow glare

0 minutes of green glare

Point Receptor: OP 15

0 minutes of yellow glare

0 minutes of green glare

Point Receptor: OP 16

0 minutes of yellow glare

0 minutes of green glare

Point Receptor: OP 17

0 minutes of yellow glare

0 minutes of green glare

ForgeSolar Glare Analysis Report – Page 14 of 15

Point Receptor: OP 18

0 minutes of yellow glare
0 minutes of green glare

Point Receptor: OP 19

0 minutes of yellow glare
0 minutes of green glare

Point Receptor: OP 20

0 minutes of yellow glare
0 minutes of green glare

Point Receptor: OP 21

0 minutes of yellow glare
0 minutes of green glare

Point Receptor: OP 22

0 minutes of yellow glare
0 minutes of green glare

Point Receptor: OP 23

0 minutes of yellow glare
0 minutes of green glare

Point Receptor: OP 24

0 minutes of yellow glare
0 minutes of green glare

Point Receptor: 25-ATCT

0 minutes of yellow glare
0 minutes of green glare

Route: Route 1

0 minutes of yellow glare
0 minutes of green glare

Route: Route 2

0 minutes of yellow glare

0 minutes of green glare

Assumptions

"Green" glare is glare with low potential to cause an after-image (flash blindness) when observed prior to a typical blink response time.

"Yellow" glare is glare with potential to cause an after-image (flash blindness) when observed prior to a typical blink response time.

Times associated with glare are denoted in Standard time. For Daylight Savings, add one hour.

Glare analyses do not account for physical obstructions between reflectors and receptors. This includes buildings, tree cover and geographic obstructions.

Several calculations utilize the PV array centroid, rather than the actual glare spot location, due to algorithm limitations. This may affect results for large PV footprints. Additional analyses of array sub-sections can provide additional information on expected glare.

The subtended source angle (glare spot size) is constrained by the PV array footprint size. Partitioning large arrays into smaller sections will reduce the maximum potential subtended angle, potentially impacting results if actual glare spots are larger than the sub-array size.

Additional analyses of the combined area of adjacent sub-arrays can provide more information on potential glare hazards. (See previous point on related limitations.)

Glare locations displayed on receptor plots are approximate. Actual glare-spot locations may differ.

Glare vector plots are simplified representations of analysis data. Actual glare emanations and results may differ.

The glare hazard determination relies on several approximations including observer eye characteristics, angle of view, and typical blink response time. Actual results and glare occurrence may differ.



Hazard zone boundaries shown in the Glare Hazard plot are an approximation and visual aid based on aggregated research data. Actual ocular impact outcomes encompass a continuous, not discrete, spectrum.

2016-2019 © Sims Industries d/b/a ForgeSolar, All Rights Reserved.

Appendix B: SGHAT/ForgeSolar Results Report for Sunrise Backtrack Simulation

ForgeSolar Report (Sunrise Backtrack Simulation, only applicable in early AM) – Pages 1-2 of 21

SITE CONFIGURATION

Analysis Parameters

DNI peaks at: 1,000.0 Wh/m²
 Time interval: 1 min
 Ocular transmission coefficient: 0.5
 Pupil diameter: 0.002 m
 Eye focal length: 0.017 m
 Sun subtended angle: 9.3 mrad
 Site Config ID: 28982-5354

PV Array(s)

Name: PV array - full parcel area
 Description: modeled to represent only auto-backtracking near sunrise
 Axis tracking: Fixed (no rotation)
 Tilt: 30.0°
 Orientation: 90.0°
 Rated power: 1990.0 kW
 Panel material: Smooth glass without AR coating
 Reflectivity: Vary with sun
 Slope error: correlate with material

Vertex	Latitude (°)	Longitude (°)	Ground elevation (ft)	Height above ground (ft)	Total elevation (ft)
1	38.227104	-122.278527	25.01	5.00	30.01
2	38.228165	-122.277958	21.79	5.00	26.80
3	38.228972	-122.278394	24.48	5.00	29.48
4	38.228460	-122.278285	26.05	5.00	31.05
5	38.228563	-122.278219	26.62	5.00	31.62
6	38.228511	-122.278554	25.23	5.00	30.23
7	38.228530	-122.279410	28.01	5.00	34.91
8	38.228427	-122.278681	28.15	5.00	33.15
9	38.227976	-122.278659	34.12	5.00	39.12
10	38.228132	-122.278654	42.34	5.00	47.34
11	38.228490	-122.278119	38.53	5.00	43.53
12	38.228474	-122.273456	45.88	5.00	50.88
13	38.228878	-122.272556	47.27	5.00	52.27
14	38.228986	-122.272610	45.63	5.00	50.64
15	38.227007	-122.278119	26.08	5.00	31.08

FORGESOLAR GLARE ANALYSIS

Project: Soscol Ferry
 A proposed 2 MW PV facility on Soscol Ferry Rd. in Napa, California. The array is single axis tracking.
 Site configuration: **baseline on full parcel 30-tilt facing East**
 Analysis conducted by Tommy Cleveland (thcleveland@gmail.com) at 03:33 on 31 Jul, 2019.

U.S. FAA 2013 Policy Adherence

The following table summarizes the policy adherence of the glare analysis based on the 2013 U.S. Federal Aviation Administration Interim Policy 76 FR 63276. This policy requires the following criteria be met for solar energy systems on airport property:

- No "yellow" glare (potential for after-image) for any flight path from threshold to 2 miles
- No glare of any kind for Air Traffic Control Tower(s) ("ATCT") at cab height.
- Default analysis and observer characteristics (see list below)

ForgeSolar does not represent or speak officially for the FAA and cannot approve or deny projects. Results are informational only.

COMPONENT	STATUS	DESCRIPTION
Analysis parameters	PASS	Analysis time interval and eye characteristics used are acceptable
Flight path(s)	FAIL	Flight path receptor(s) receive yellow glare
ATCT(s)	PASS	Receptor(s) marked as ATCT do not receive glare

Default glare analysis parameters and observer eye characteristics (for reference only):

- Analysis time interval: 1 minute
- Ocular transmission coefficient: 0.5
- Pupil diameter: 0.002 meters
- Eye focal length: 0.017 meters
- Sun subtended angle: 9.3 milliradians

FAA Policy 76 FR 63276 can be read at <https://www.federalregister.gov/2013-24729>

July 31, 2019

ForgeSolar Report (Sunrise Backtrack Simulation, only applicable in early AM) – Pages 3-4 of 21

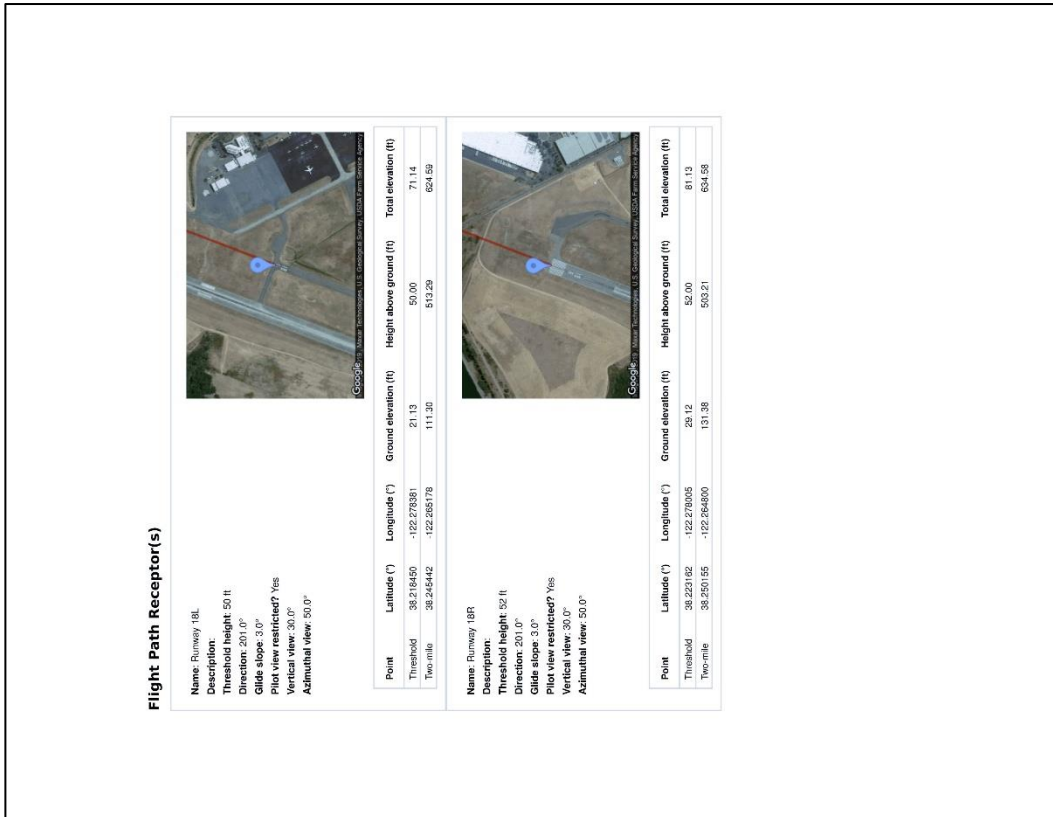
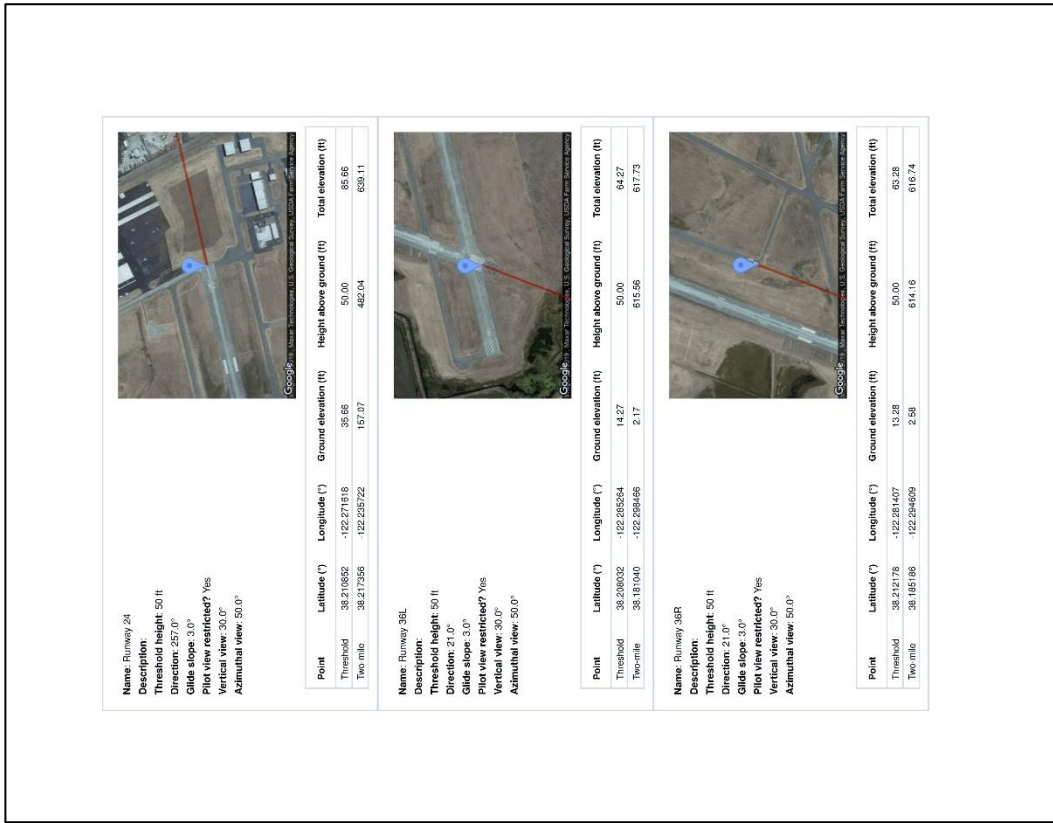

ForgeSolar Report (Sunrise Backtrack Simulation, only applicable in early AM) – Pages 5-6 of 21

Discrete Observation Receptors

Name	ID	Latitude (°)	Longitude (°)	Elevation (ft)	Height (ft)
OP 1	1	38.238531	-122.288469	66.04	6.00
OP 2	2	38.238271	-122.288454	66.27	6.00
OP 3	3	38.237167	-122.285653	61.21	6.00
OP 4	4	38.235844	-122.287674	54.88	6.00
OP 5	5	38.237930	-122.284432	16.46	6.00
OP 6	6	38.237717	-122.284161	12.92	6.00
OP 7	7	38.244807	-122.279569	29.05	6.00
OP 8	8	38.245461	-122.275703	32.79	6.00
OP 9	9	38.245427	-122.274651	30.34	6.00
OP 10	10	38.245369	-122.273343	31.57	6.00
OP 11	11	38.240774	-122.275969	49.35	6.00
OP 12	12	38.240728	-122.272557	55.53	6.00
OP 13	13	38.240128	-122.273030	43.38	6.00
OP 14	14	38.240249	-122.270769	60.17	6.00
OP 15	15	38.240015	-122.269700	60.88	6.00
OP 16	16	38.238644	-122.260720	57.37	6.00
OP 17	17	38.235931	-122.255235	41.93	6.00
OP 18	18	38.236550	-122.256669	41.50	6.00
OP 19	19	38.236623	-122.272918	24.91	6.00
OP 20	20	38.244218	-122.265653	17.13	6.00
OP 21	21	38.250468	-122.267603	56.28	6.00
OP 22	22	38.242743	-122.281441	152.95	6.00
OP 23	23	38.238589	-122.285716	297.97	6.00
OP 24	24	38.230324	-122.288410	76.08	6.00
25-ATCT	25	38.207859	-122.279153	20.73	50.00



Name: Runway 6
Description:
Threshold height: 50 ft
Direction: 80.0°
Glide slope: 3.0°
Pilot view restricted? Yes
Vertical view: 30.0°
Azimuthal view: 50.0°



Point	Latitude (°)	Longitude (°)	Ground elevation (ft)	Height above ground (ft)	Total elevation (ft)
Threshold	38.207728	-122.288439	13.93	50.00	63.93
Two mile	38.202707	-122.324718	4.48	612.90	617.38

ForgeSolar Report (Sunrise Backtrack Simulation, only applicable in early AM) – Pages 7-8 of 21

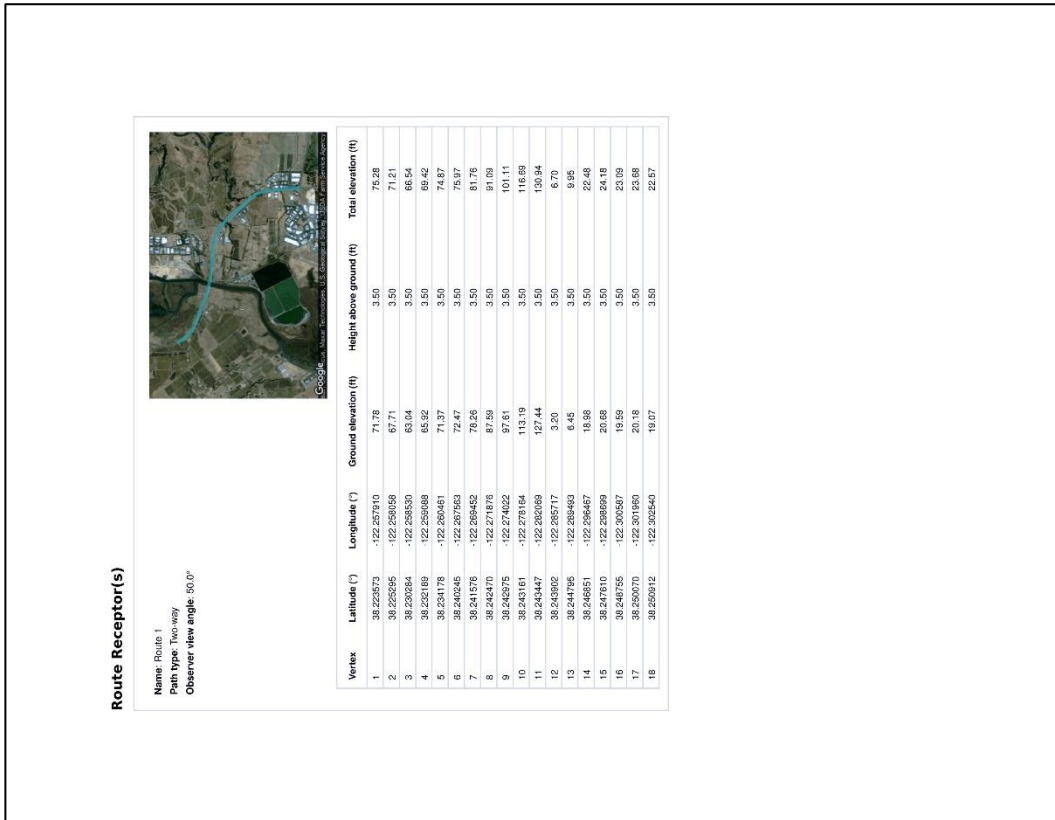

ForgeSolar Report (Sunrise Backtrack Simulation, only applicable in early AM) – Pages 9-10 of 21

Receptor	Annual Green Glare (min)	Annual Yellow Glare (min)
OP 5	0	0
OP 6	0	0
OP 7	0	0
OP 8	0	0
OP 9	0	0
OP 10	0	27
OP 11	304	3609
OP 12	776	3301
OP 13	934	3190
OP 14	1341	3313
OP 15	1878	1487
OP 16	0	0
OP 17	0	0
OP 18	0	0
OP 19	0	0
OP 20	0	0
OP 21	0	960
OP 22	1366	0
OP 23	1544	0
OP 24	0	0
25-ATCT	0	0
Route 1	118	284
Route 2	6	98
Route 3	193	525

Receptor	Green Glare (min)	Yellow Glare (min)
Runway 18L	6780	0
Runway 18R	14199	1333
Runway 24	0	0
Runway 36L	0	0
Runway 36R	0	0
Runway 6	1639	33
OP 1	664	1
OP 2	0	0
OP 3	0	0
OP 4	0	0
OP 5	0	0
OP 6	0	0

Results for: PV array - full parcel area

Name: Route 3
Path type: Two-way
Observer view angle: 50.0°



Vertex	Latitude (°)	Longitude (°)	Ground elevation (ft)	Height above ground (ft)	Total elevation (ft)
1	38.241868	-122.285642	81.72	3.50	85.22
2	38.241105	-122.289459	72.51	3.50	76.01
3	38.240616	-122.270093	63.08	3.50	66.58
4	38.240422	-122.270758	57.29	3.50	60.79
5	38.240566	-122.274181	42.25	3.50	45.75
6	38.240548	-122.275985	37.13	3.50	40.63
7	38.240717	-122.276518	36.46	3.50	39.96

GLARE ANALYSIS RESULTS

Summary of Glare

PV Array Name	Tilt (°)	Orient (°)	"Green" Glare		"Yellow" Glare		Energy kWh
			min	min	min	min	
PV array - full parcel area	30.0	90.0	31,742	18,161	3,637,000.0		

Total annual glare received by each receptor

Receptor	Annual Green Glare (min)	Annual Yellow Glare (min)
Runway 18L	6780	0
Runway 18R	14199	1333
Runway 24	0	0
Runway 36L	0	0
Runway 36R	0	0
Runway 6	1639	33
OP 1	664	1
OP 2	0	0
OP 3	0	0
OP 4	0	0

ForgeSolar Report (Sunrise Backtrack Simulation, only applicable in early AM) – Pages 11-12 of 21

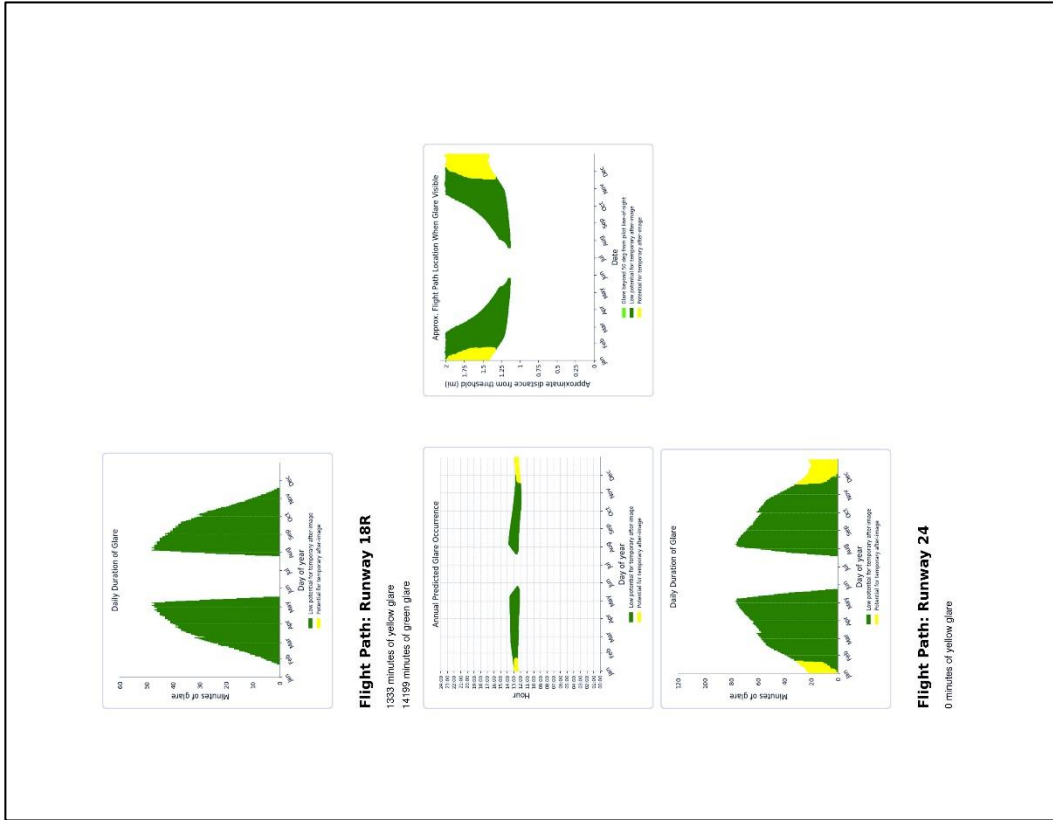
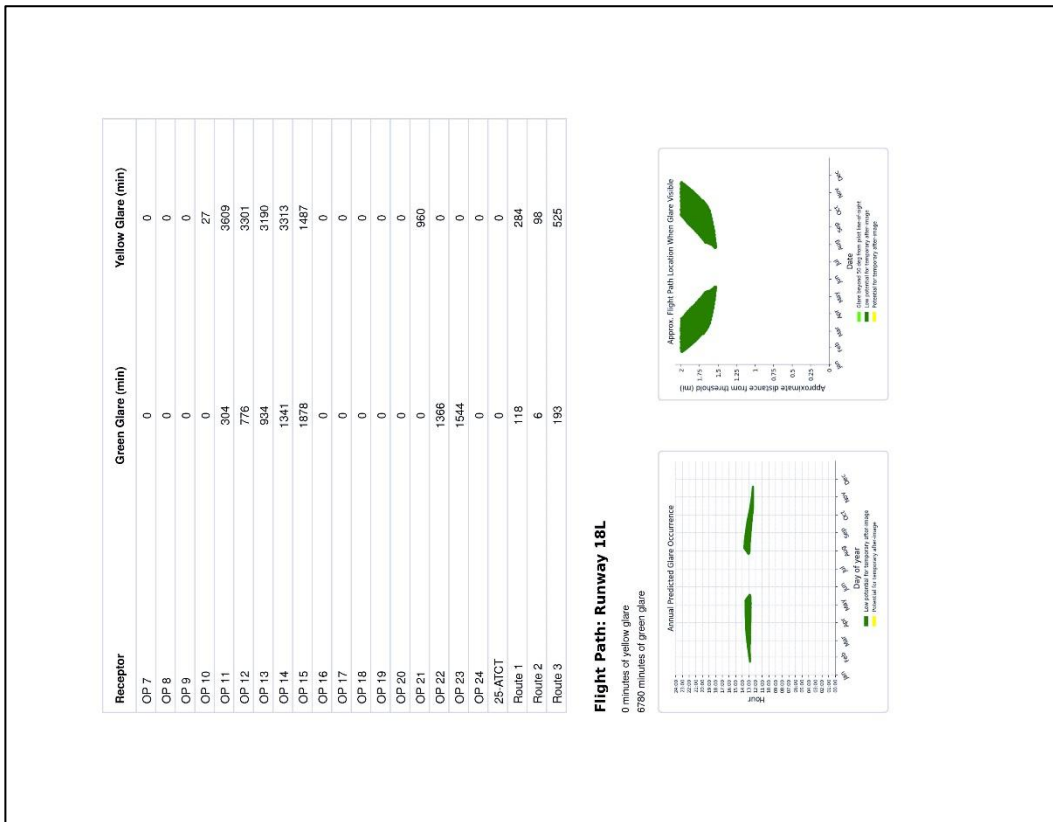

ForgeSolar Report (Sunrise Backtrack Simulation, only applicable in early AM) – Pages 13-14 of 21

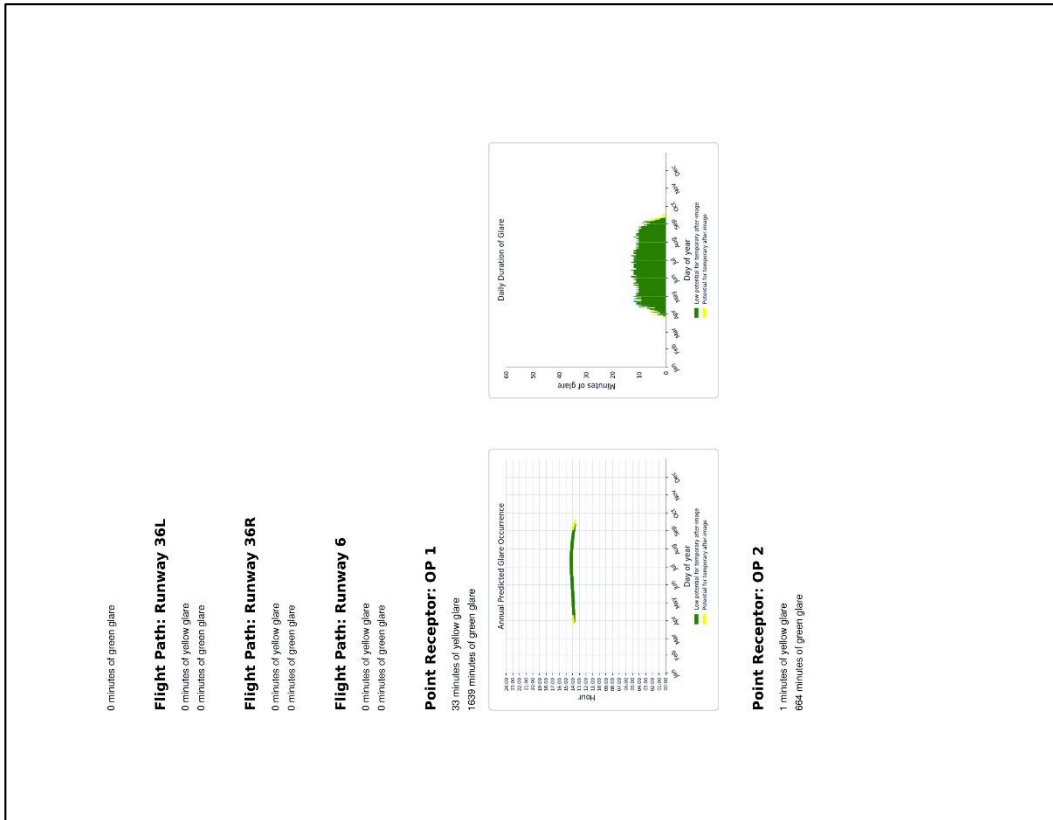
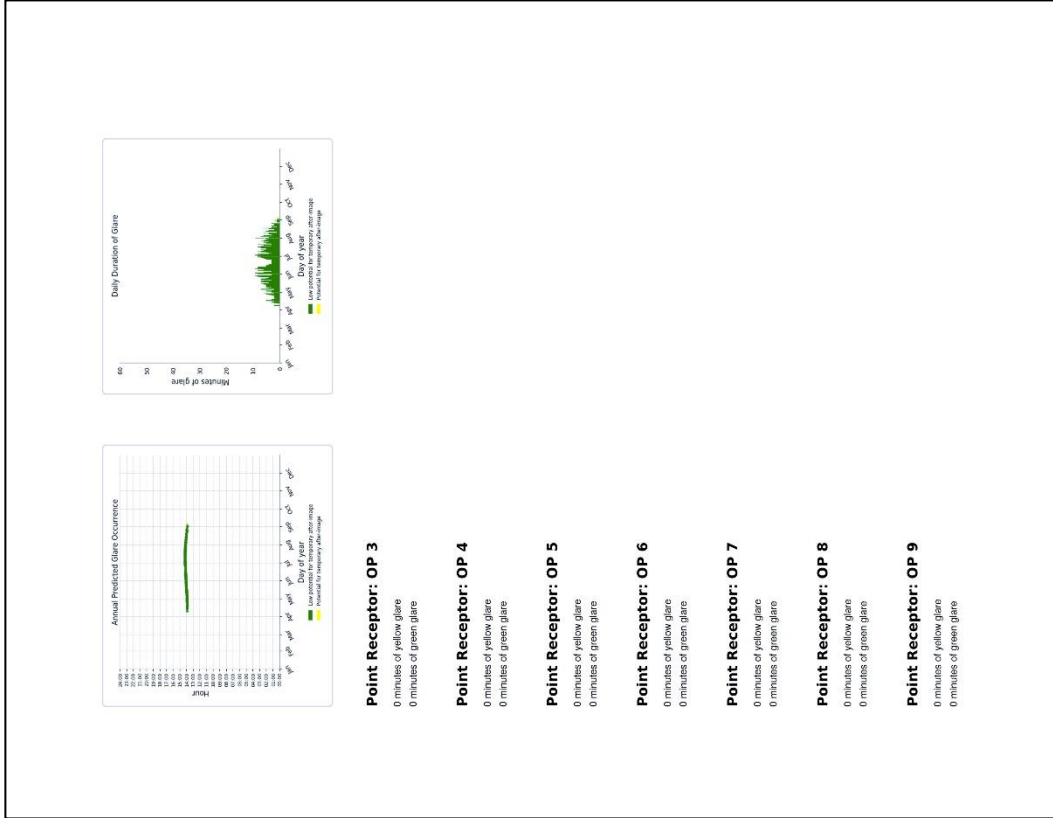

ForgeSolar Report (Sunrise Backtrack Simulation, only applicable in early AM) – Page 15-16 of 21

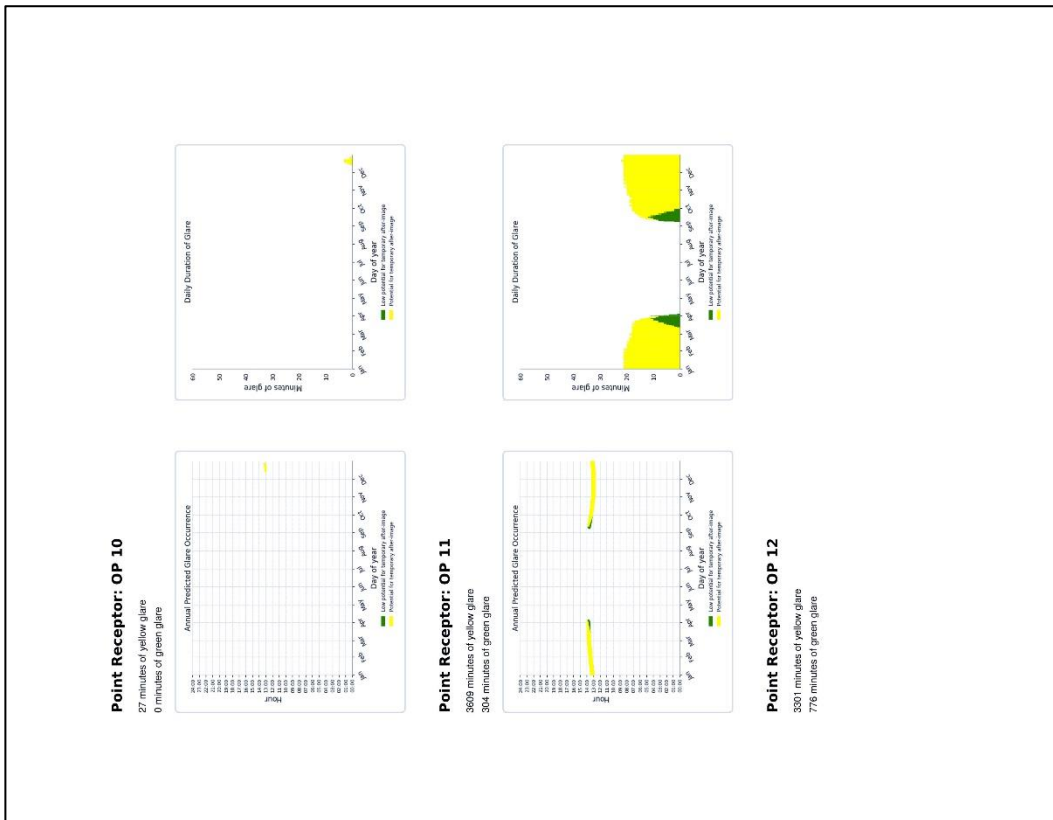
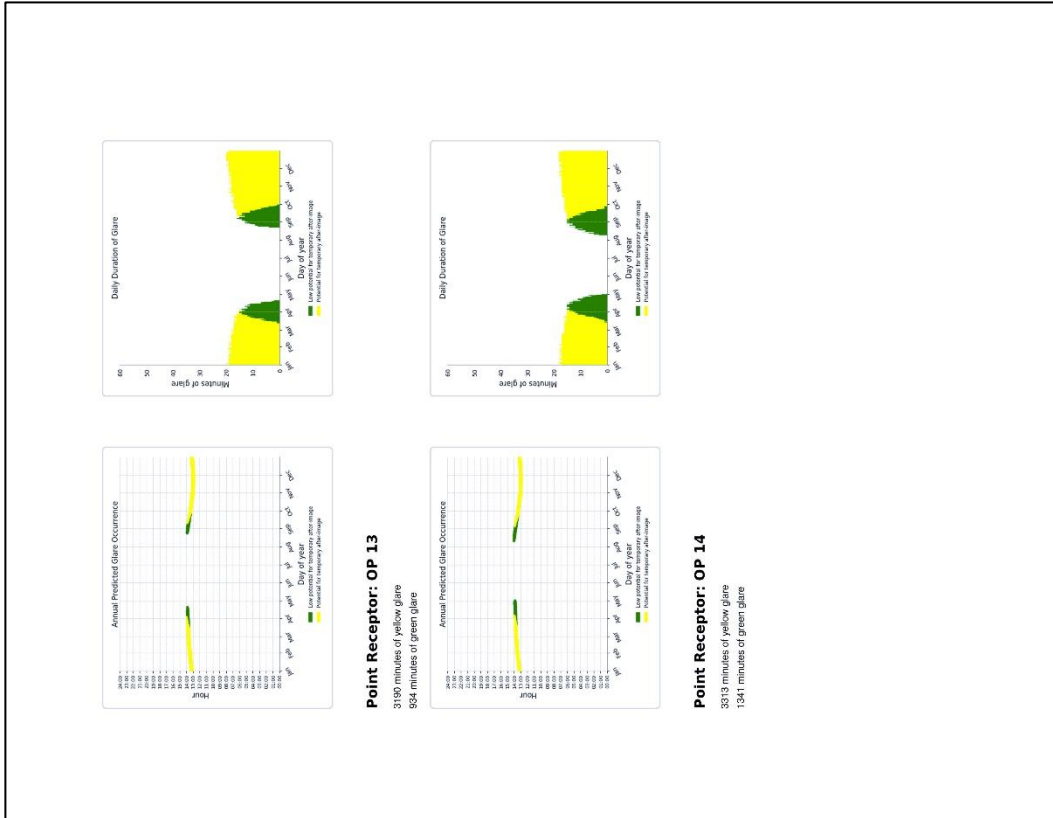

ForgeSolar Report (Sunrise Backtrack Simulation, only applicable in early AM) – Pages 17-18 of 21

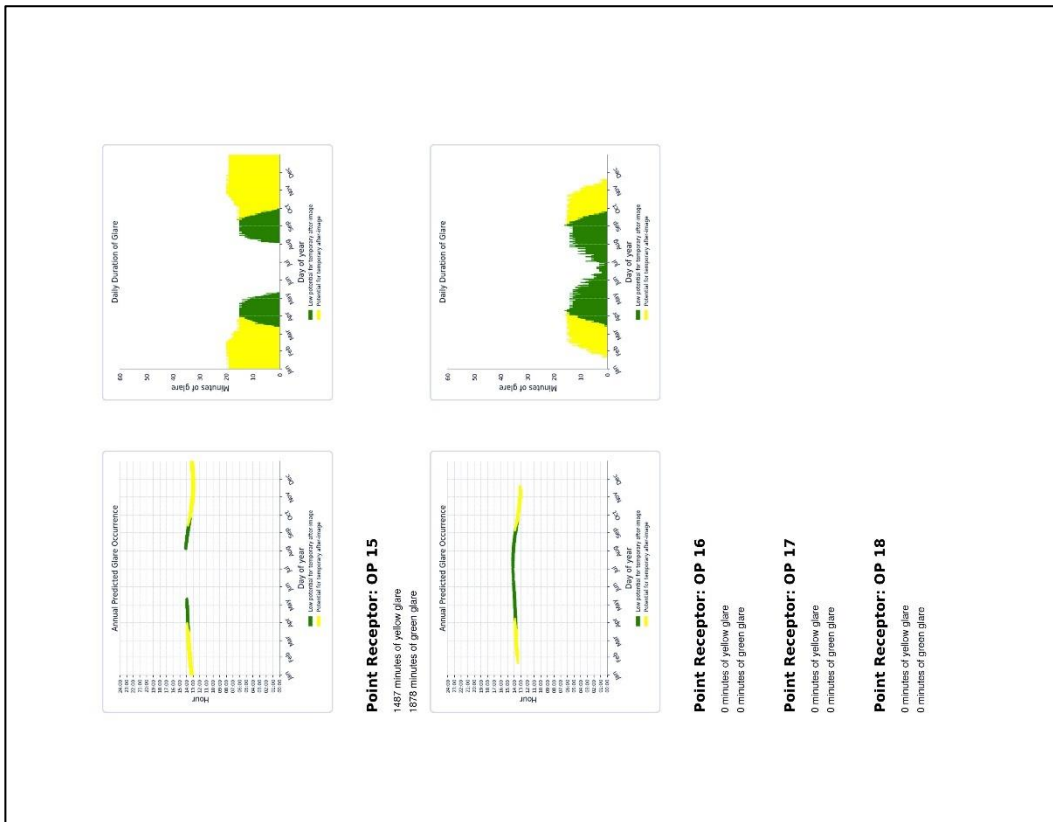
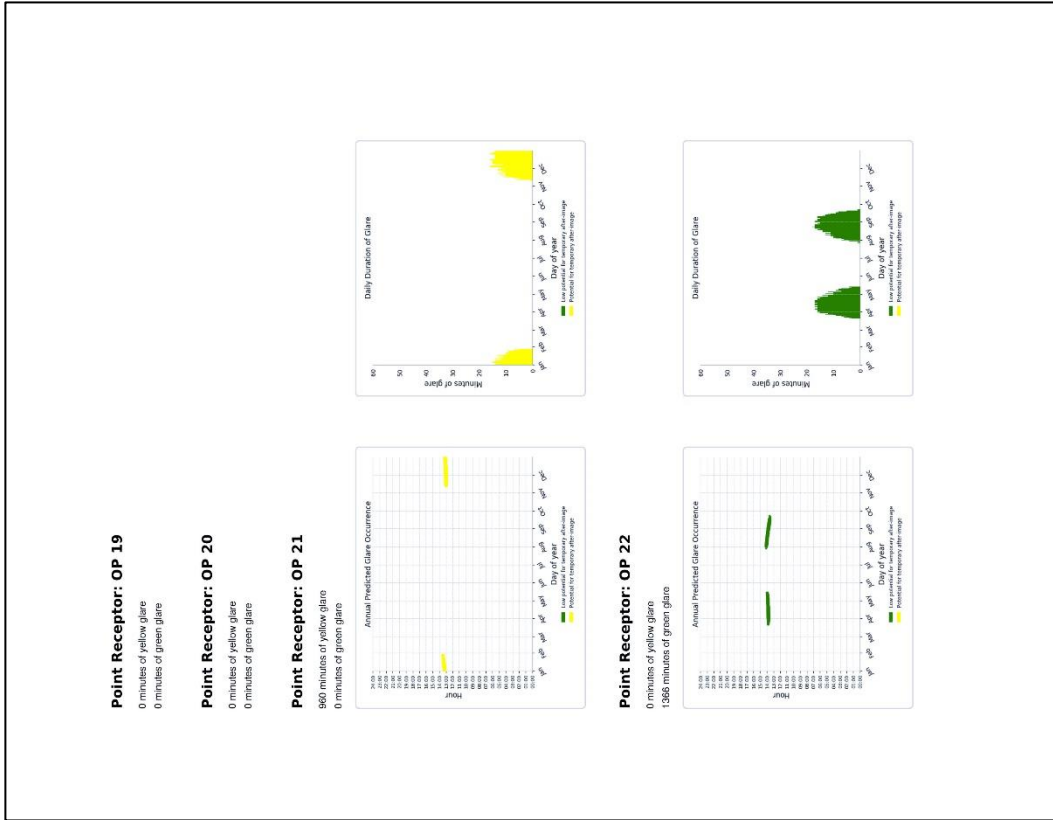

ForgeSolar Report (Sunrise Backtrack Simulation, only applicable in early AM) – Pages 19-20 of 21

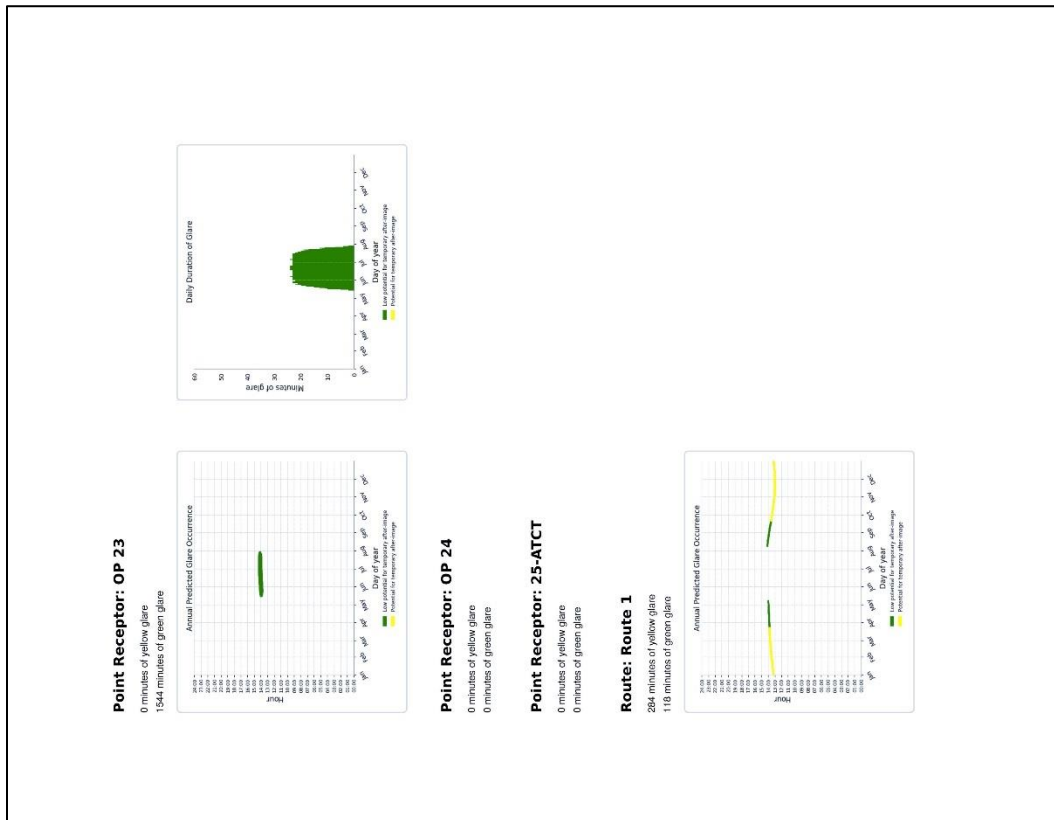
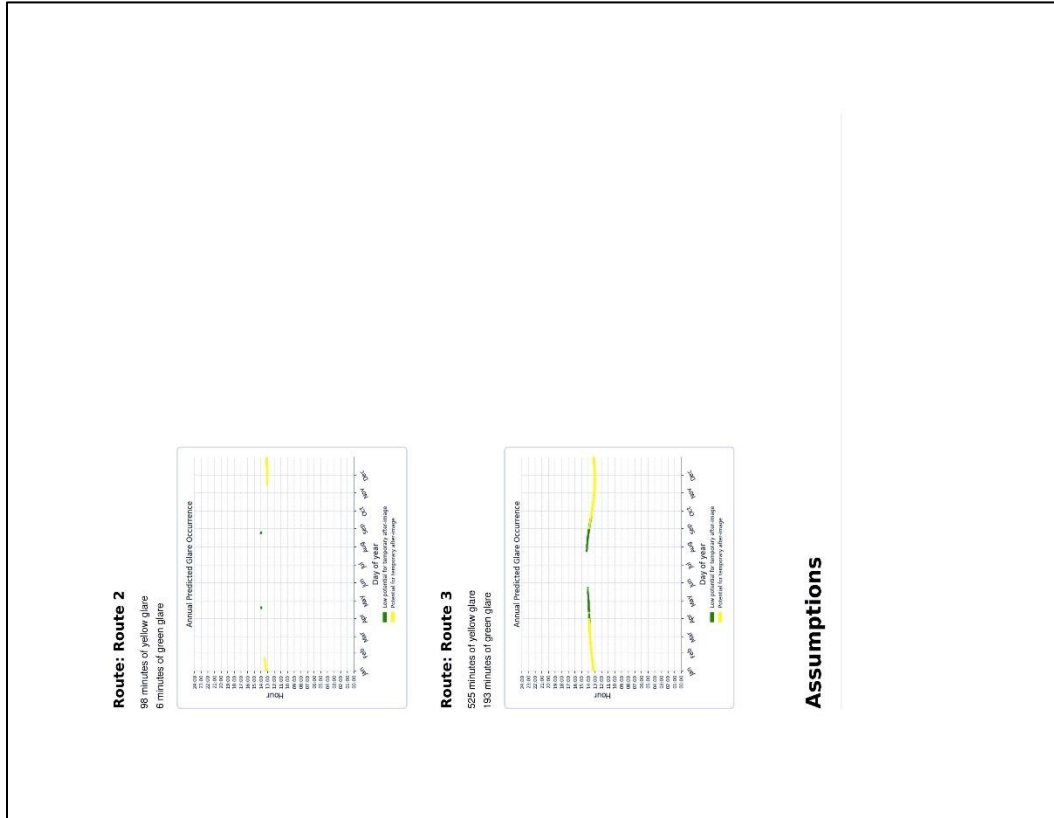

ForgeSolar Report (Sunrise Backtrack Simulation, only applicable in early AM) – Page 21 of 21

Green glare is glare with low potential to cause an after image (flash blindness) when observed prior to a typical blink response time.
Yellow glare is glare with potential to cause an after image (flash blindness) when observed prior to a typical blink response time.
Red glare is glare with potential to cause an after image (flash blindness) when observed prior to a typical blink response time.
Times associated with glare are denoted in Standard time. For Daylight Savings, add one hour.
Glare analyses do not account for physical obstructions between reflectors and receptors. This includes buildings, tree cover and geographic obstructions.
Several calculations utilize the PV array centroid, rather than the actual glare spot location, due to algorithm limitations. This may affect results for large PV footprints. Additional analyses of array sub-sections can provide additional information on expected glare.
The subtended source angle (glare spot size) is constrained by the PV array footprint size. Partitioning large arrays into smaller sections will reduce the maximum potential subtended angle, potentially impacting results if actual glare spots are larger than the sub-array size.
Additional analyses of the combined area of adjacent sub-arrays can provide more information on potential glare hazards. (See previous point on related limitations.)
Glare locations displayed on receptor plots are approximate. Actual glare-spot locations may differ.
Glare vector plots are simplified representations of analysis data. Actual glare emanations and results may differ.
The glare hazard determination relies on several approximations including observer eye characteristics, angle of view, and typical blink response time. Actual results and glare occurrence may differ.
Hazard zone boundaries shown in the Glare Hazard plot are an approximation and visual aid based on aggregated research data. Actual ocular impact outcomes encompass a continuous, not discrete, spectrum.

2016-2019 © Sims Industries dba ForgeSolar. All Rights Reserved.

Appendix C: SGHAT/ForgeSolar Results Report for Sunset Backtrack Simulation

ForgeSolar Report (Sunset Backtrack Simulation, only applicable in late PM) – Pages 1-2 of 17

SITE CONFIGURATION



Analysis Parameters

DNI peaks at 1,000.0 W/m²
 Time interval: 1 min
 Ocular transmission coefficient: 0.5
 Pixel diameter: 0.002 m
 Eye focal length: 0.017 m
 Sun subtended angle: 9.3 mrad
 Site Config ID: 28969.5354



PV Array(s)

Name: PV array - full parcel area
Description: modified to represent only auto-backtracking near sunset
Axis tracking: Fixed (no rotation)
Tilt: 30.0°
Orientation: 270.0°
Rated power: 1890.0 kW
Panel material: Smooth glass without AR coating
Reflectivity: Vary with sun
Slope error: correlate with material

Vertex	Latitude (°)	Longitude (°)	Ground elevation (ft)	Height above ground (ft)	Total elevation (ft)
1	38.237104	-122.278527	25.01	5.00	30.01
2	38.238951	-122.277958	21.79	5.00	26.80
3	38.238972	-122.276784	24.88	5.00	29.88
4	38.238490	-122.276295	26.05	5.00	31.05
5	38.238953	-122.275969	26.42	5.00	31.42
6	38.238511	-122.275534	25.23	5.00	30.23
7	38.238330	-122.275410	29.51	5.00	34.51
8	38.238427	-122.274881	28.15	5.00	33.15
9	38.237976	-122.274659	34.12	5.00	39.12
10	38.238132	-122.274064	42.34	5.00	47.34
11	38.238490	-122.273619	38.53	5.00	43.53
12	38.238474	-122.273345	45.88	5.00	50.88
13	38.238878	-122.272556	47.27	5.00	52.27
14	38.238986	-122.272610	45.63	5.00	50.64
15	38.237007	-122.278119	28.08	5.00	31.08



FORGESOLAR GLARE ANALYSIS

Project: Soscol Ferry
 A proposed 2 MW PV facility on Soscol Ferry Rd. in Napa, California. The array is single axis tracking.

Site configuration: **baseline on full parcel 30-tilt facing West**
 Analysis conducted by Tommy Cleveland (thcleveand@gmail.com) at 11:34 on 31. Jul. 2019.

U.S. FAA 2013 Policy Adherence

The following table summarizes the policy adherence of the glare analysis based on the 2013 U.S. Federal Aviation Administration Interim Policy 78 FR 63276. This policy requires the following criteria be met for solar energy systems on airport property:

- No "yellow" glare (potential for close images) for any flight path from thresholds to 2 miles
- No glare of any kind for Air Traffic Control Towers ("ATCT") at cab height.
- Default analysis and observer characteristics (see list below)

ForgeSolar does not represent or speak officially for the FAA and cannot approve or deny projects. Results are informational only.

COMPONENT	STATUS	DESCRIPTION
Analysis parameters	PASS	Analysis time interval and eye characteristics used are acceptable
Flight path(s)	PASS	Flight path receptor(s) do not receive yellow glare
ATCT(s)	PASS	Receptor(s) marked as ATCT do not receive glare

Default glare analysis parameters and observer eye characteristics (for reference only):

- Analysis time interval: 1 minute
- Ocular transmission coefficient: 0.5
- Pixel diameter: 0.002 meters
- Eye focal length: 0.017 meters
- Sun subtended angle: 9.3 milliradians

FAA Policy 78 FR 63276 can be read at <https://www.federalregister.gov/d/2013-24729>

July 31, 2019

ForgeSolar Report (Sunset Backtrack Simulation, only applicable in late PM) – Pages 3-4 of 17

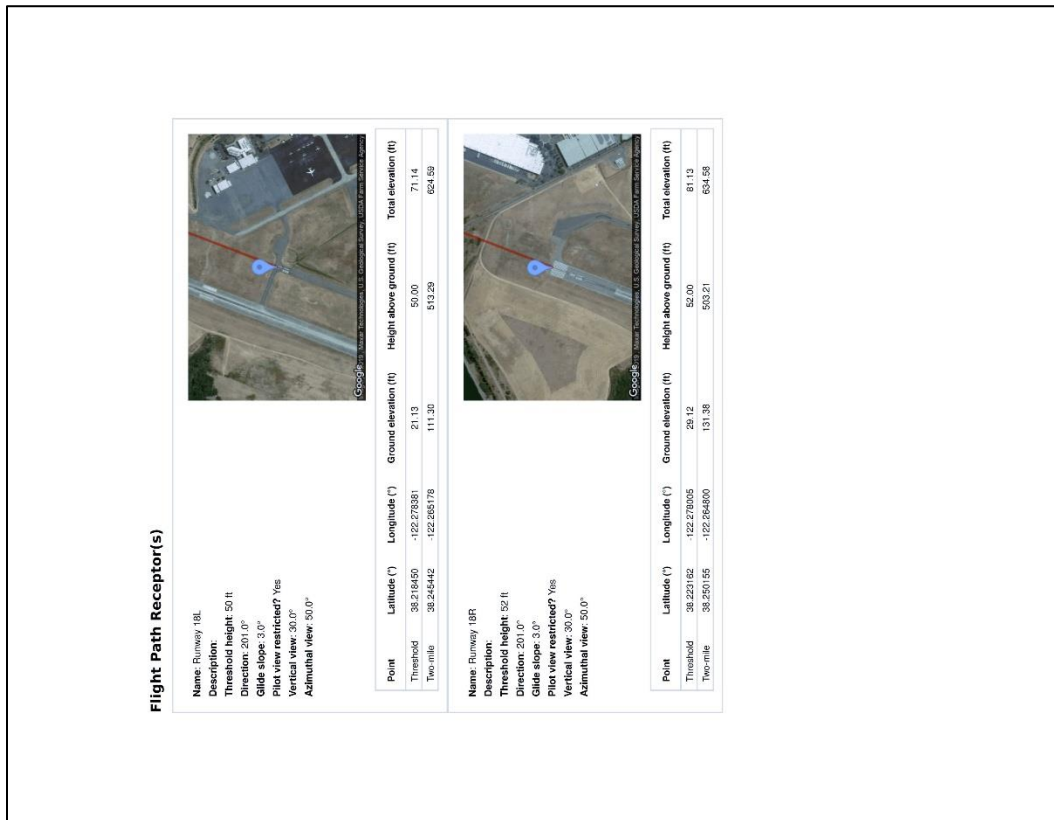
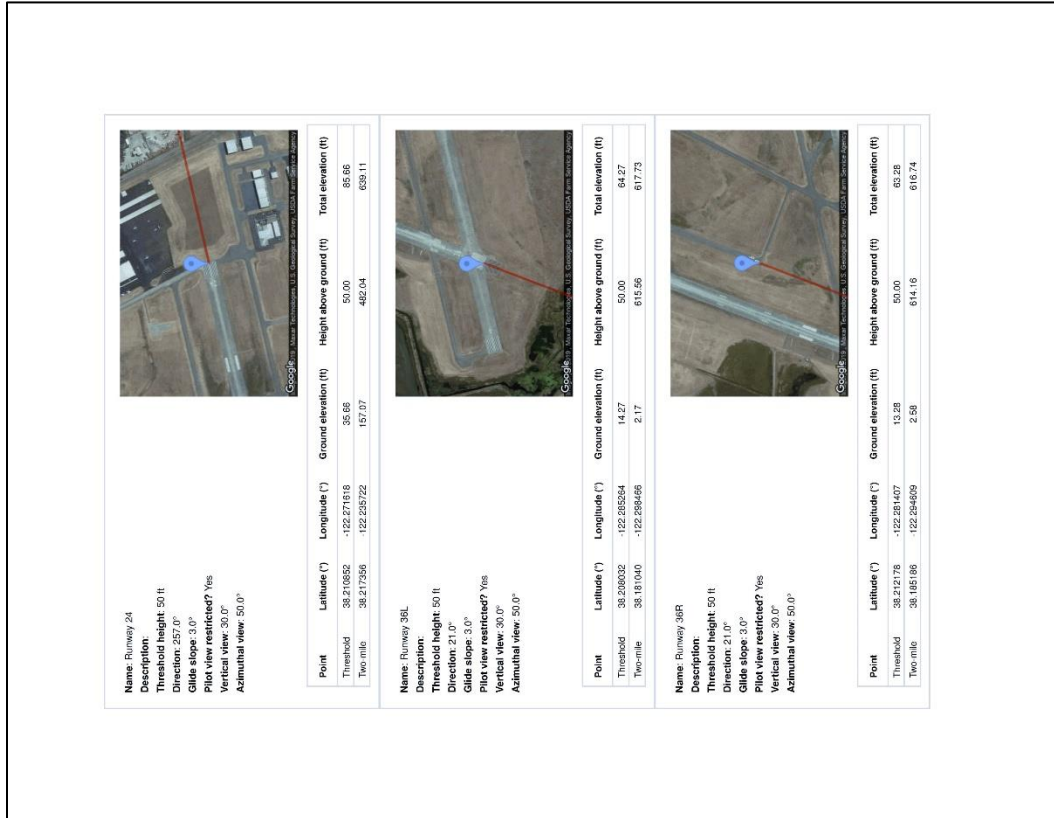

ForgeSolar Report (Sunset Backtrack Simulation, only applicable in late PM) – Pages 5-6 of 17

Discrete Observation Receptors

Name	ID	Latitude (°)	Longitude (°)	Elevation (ft)	Height (ft)
OP 1	1	38.238531	-122.289489	66.04	6.00
OP 2	2	38.238271	-122.289454	66.27	6.00
OP 3	3	38.237167	-122.286653	61.21	6.00
OP 4	4	38.235844	-122.287874	54.88	6.00
OP 5	5	38.237030	-122.284632	16.46	6.00
OP 6	6	38.237717	-122.284761	12.92	6.00
OP 7	7	38.244807	-122.279589	29.05	6.00
OP 8	8	38.244811	-122.275703	32.79	6.00
OP 9	9	38.245427	-122.274651	30.34	6.00
OP 10	10	38.245388	-122.273343	31.57	6.00
OP 11	11	38.240774	-122.273569	48.35	6.00
OP 12	12	38.240728	-122.272657	53.53	6.00
OP 13	13	38.241028	-122.270030	43.38	6.00
OP 14	14	38.240545	-122.270788	60.17	6.00
OP 15	15	38.240015	-122.269700	66.88	6.00
OP 16	16	38.238644	-122.269700	57.37	6.00
OP 17	17	38.236531	-122.265256	41.93	6.00
OP 18	18	38.236550	-122.268669	41.50	6.00
OP 19	19	38.236823	-122.272918	24.91	6.00
OP 20	20	38.244318	-122.269859	17.13	6.00
OP 21	21	38.256408	-122.287803	59.28	6.00
OP 22	22	38.247543	-122.281441	152.46	6.00
OP 23	23	38.236589	-122.283716	292.97	6.00
OP 24	24	38.238584	-122.288410	76.08	6.00
25 ATCT	25	38.207659	-122.279153	207.3	50.00



Name: Runway 6
Description:
Threshold height: 50 ft
Direction: 80.0°
Glide slope: 3.0°
Pilot view restricted? Yes
Vertical view: 30.0°
Azimuthal view: 50.0°



Point	Latitude (°)	Longitude (°)	Ground elevation (ft)	Height above ground (ft)	Total elevation (ft)
Threshold	38.207726	-122.288459	13.93	50.00	63.93
Two mls	38.232707	-122.324718	4.48	612.90	617.38

ForgeSolar Report (Sunset Backtrack Simulation, only applicable in late PM) – Pages 7-8 of 17

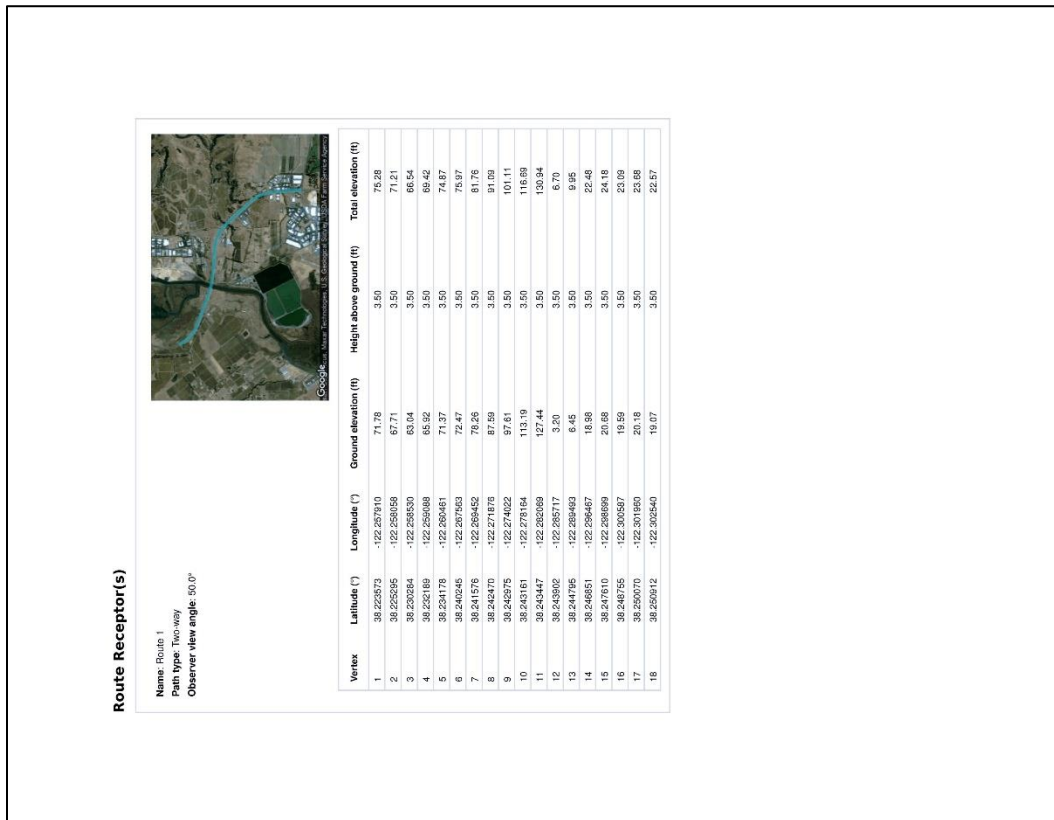

ForgeSolar Report (Sunset Backtrack Simulation, only applicable in late PM) – Pages 9-10 of 17

Receptor	Annual Green Glare (min)	Annual Yellow Glare (min)
OP 5	0	0
OP 6	95	0
OP 7	0	2238
OP 8	0	0
OP 9	0	0
OP 10	0	0
OP 11	0	0
OP 12	0	0
OP 13	0	0
OP 14	0	0
OP 15	0	0
OP 16	0	0
OP 17	0	0
OP 18	0	0
OP 19	0	0
OP 20	1287	0
OP 21	0	0
OP 22	0	0
OP 23	0	0
OP 24	0	0
25-ATCT	0	0
Route 1	1904	1967
Route 2	970	1066
Route 3	394	7

Receptor	Green Glare (min)	Yellow Glare (min)
Runway 18L	0	0
Runway 18R	0	0
Runway 24	0	0
Runway 36L	0	0
Runway 36R	0	0
Runway 6	0	0
OP 1	0	0
OP 2	0	0
OP 3	0	0
OP 4	0	0
OP 5	0	0
OP 6	95	0

Results for: PV array - full parcel area



Names: Route 3
 Path type: Two-way
 Observer view angle: 50.0°

Vertex	Latitude (°)	Longitude (°)	Ground elevation (ft)	Height above ground (ft)	Total elevation (ft)
1	38.241666	-122.289642	81.72	3.50	85.22
2	38.241105	-122.289439	72.51	3.50	76.01
3	38.240616	-122.270083	63.08	3.50	66.58
4	38.240422	-122.270758	57.29	3.50	60.79
5	38.240506	-122.274181	42.25	3.50	45.75
6	38.240548	-122.275585	37.13	3.50	40.63
7	38.240717	-122.276318	36.46	3.50	39.96

GLARE ANALYSIS RESULTS

Summary of Glare

PV Array Name	Tilt (°)	Orient (°)	"Green" Glare min	"Green" Glare max	"Yellow" Glare min	"Yellow" Glare max	Energy kWh
PV array - full parcel area	30.0	270.0	4,650	5,338	5,338	5,338	3,637,000.0

Total annual glare received by each receptor

Receptor	Annual Green Glare (min)	Annual Yellow Glare (min)
Runway 18L	0	0
Runway 18R	0	0
Runway 24	0	0
Runway 36L	0	0
Runway 36R	0	0
Runway 6	0	0
OP 1	0	0
OP 2	0	0
OP 3	0	0
OP 4	0	0



ForgeSolar Report (Sunset Backtrack Simulation, only applicable in late PM) – Pages 11-12 of 17

Flight Path: Runway 36R	0 minutes of yellow glare 0 minutes of green glare
Flight Path: Runway 6	0 minutes of yellow glare 0 minutes of green glare
Point Receptor: OP 1	0 minutes of yellow glare 0 minutes of green glare
Point Receptor: OP 2	0 minutes of yellow glare 0 minutes of green glare
Point Receptor: OP 3	0 minutes of yellow glare 0 minutes of green glare
Point Receptor: OP 4	0 minutes of yellow glare 0 minutes of green glare
Point Receptor: OP 5	0 minutes of yellow glare 0 minutes of green glare
Point Receptor: OP 6	0 minutes of yellow glare 0 minutes of green glare

Receptor	Green Glare (min)	Yellow Glare (min)
OP 7	0	2298
OP 8	0	0
OP 9	0	0
OP 10	0	0
OP 11	0	0
OP 12	0	0
OP 13	0	0
OP 14	0	0
OP 15	0	0
OP 16	0	0
OP 17	0	0
OP 18	0	0
OP 19	0	0
OP 20	1267	0
OP 21	0	0
OP 22	0	0
OP 23	0	0
OP 24	0	0
25-ATCT	0	0
Route 1	1904	1967
Route 2	970	1066
Route 3	394	7

Flight Path: Runway 18L	0 minutes of yellow glare 0 minutes of green glare
Flight Path: Runway 18R	0 minutes of yellow glare 0 minutes of green glare
Flight Path: Runway 24	0 minutes of yellow glare 0 minutes of green glare
Flight Path: Runway 36L	0 minutes of yellow glare 0 minutes of green glare



ForgeSolar Report (Sunset Backtrack Simulation, only applicable in late PM) – Pages 13-14 of 17

<p>Point Receptor: OP 11 0 minutes of yellow glare 0 minutes of green glare</p>
<p>Point Receptor: OP 12 0 minutes of yellow glare 0 minutes of green glare</p>
<p>Point Receptor: OP 13 0 minutes of yellow glare 0 minutes of green glare</p>
<p>Point Receptor: OP 14 0 minutes of yellow glare 0 minutes of green glare</p>
<p>Point Receptor: OP 15 0 minutes of yellow glare 0 minutes of green glare</p>
<p>Point Receptor: OP 16 0 minutes of yellow glare 0 minutes of green glare</p>
<p>Point Receptor: OP 17 0 minutes of yellow glare 0 minutes of green glare</p>
<p>Point Receptor: OP 18 0 minutes of yellow glare 0 minutes of green glare</p>
<p>Point Receptor: OP 19 0 minutes of yellow glare 0 minutes of green glare</p>
<p>Point Receptor: OP 20 0 minutes of yellow glare</p>

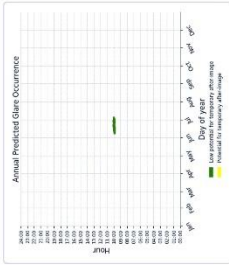
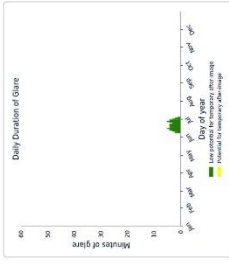
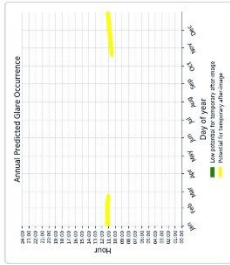
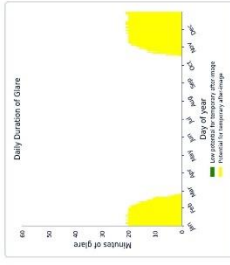
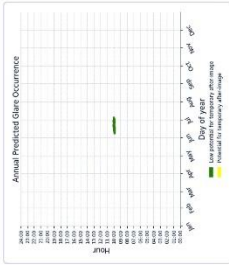
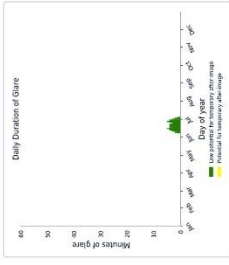
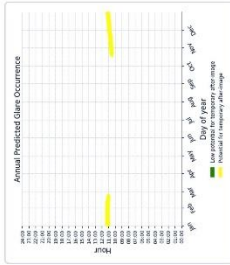
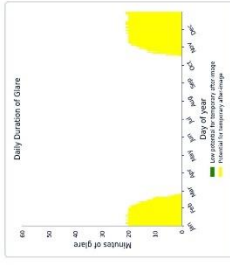
 <p>Point Receptor: OP 7 2398 minutes of yellow glare 0 minutes of green glare</p>	
 <p>Point Receptor: OP 8 0 minutes of yellow glare 0 minutes of green glare</p>	
 <p>Point Receptor: OP 9 0 minutes of yellow glare 0 minutes of green glare</p>	
 <p>Point Receptor: OP 10 0 minutes of yellow glare 0 minutes of green glare</p>	



ForgeSolar Report (Sunset Backtrack Simulation, only applicable in late PM) – Pages 15-16 of 17

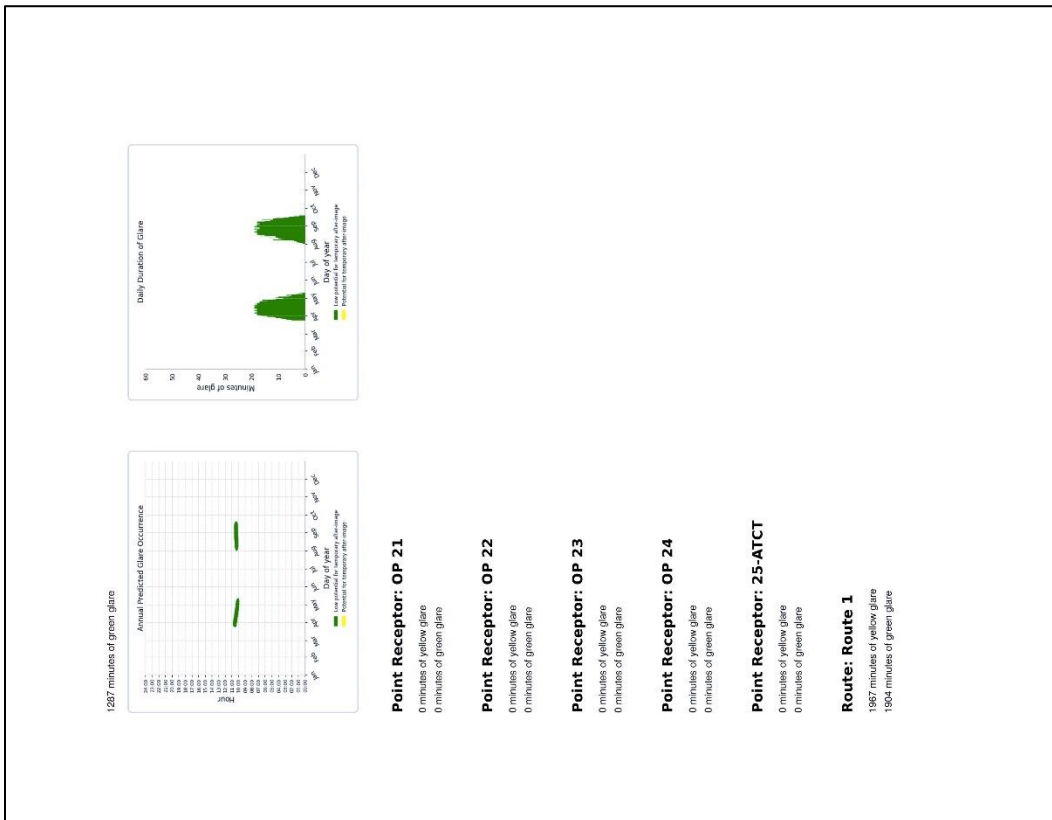
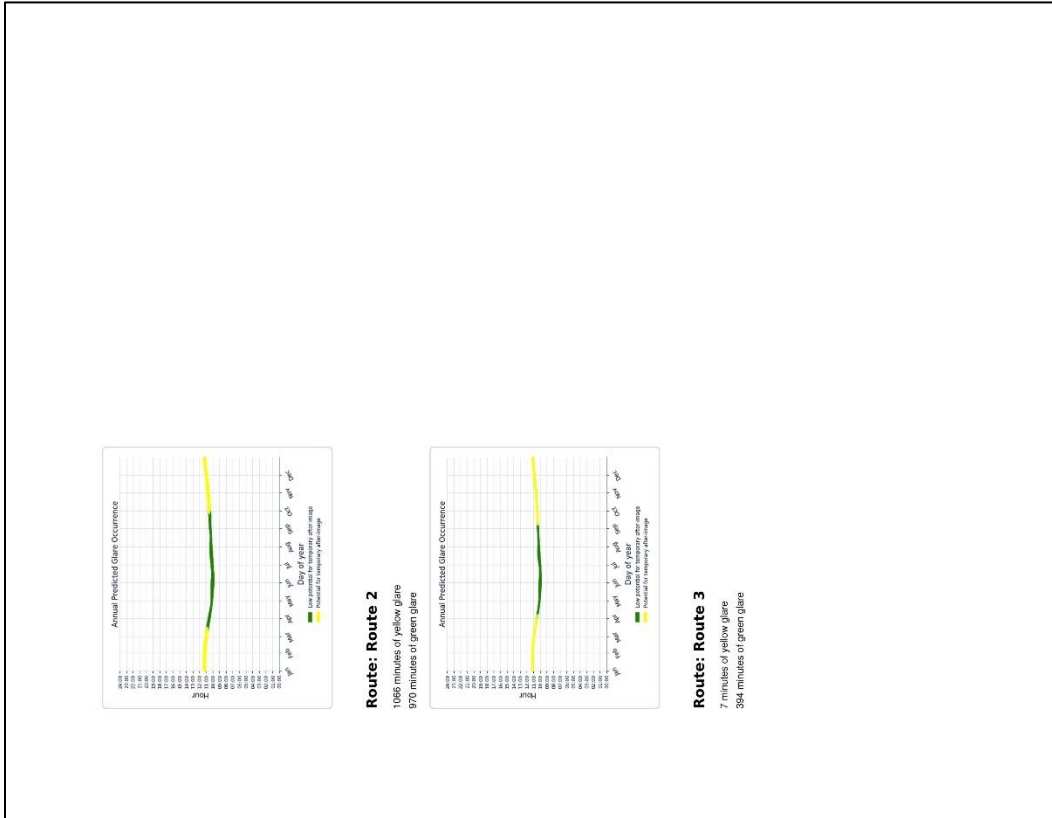

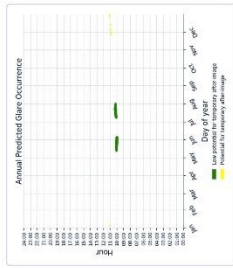

Assumptions

"Green" glare is glare with low potential to cause an after-image (flash blindness) when observed prior to a typical blink response time. "Yellow" glare is glare with potential to cause an after-image (flash blindness) when observed prior to a typical blink response time. Times associated with glare are denoted in Standard time. For Daylight Savings, add one hour. Glare analyses do not account for physical obstructions between reflectors and receptors. This includes buildings, tree cover and geographic obstructions. Several calculations utilize the PV array centroid, rather than the actual glare spot location, due to algorithm limitations. This may affect results for large PV footprints. Additional analyses of array sub-sections can provide additional information on expected glare. The subtended source angle (glare spot size) is constrained by the PV array footprint size. Partitioning large arrays into smaller sections will reduce the maximum potential subtended angle, potentially impacting results if actual glare spots are larger than the sub-array size. Additional analyses of the combined area of adjacent sub-arrays can provide more information on potential glare hazards. (See previous point on related limitations.) Glare locations displayed on receptor plots are approximate. Actual glare spot locations may differ. Glare vector plots are simplified representations of analysis data. Actual glare emanations and results may differ. The glare hazard determination relies on several approximations including observer eye characteristics, angle of view, and typical blink response time. Actual results and glare occurrence may differ. Hazard zone boundaries shown in the Glare Hazard plot are an approximation and visual aid based on aggregated research data. Actual ocular impact outcomes encompass a continuous, not discrete, spectrum.

2016-2019 © Sims Industries dba ForgeSolar. All Rights Reserved.



Appendix D: Thomas Cleveland's CV

Thomas (Tommy) H. Cleveland, P.E.

4141 Laurel Hills Rd. Raleigh, NC

thcleveland@gmail.com

919-923-5490

Education & Training

North Carolina State University, Mechanical Engineering M.S. 2004

North Carolina State University, Mechanical Engineering B.S., Business Mgmt. minor 2001 - Summa Cum Laude

Lumberton Sr. High School, Lumberton, NC, 1997 – Valedictorian

Professional Engineer, licensed in North Carolina (#033711), 2008 - Present

Professional Experience

Solar PV Engineer, Advanced Energy, Raleigh, NC, April 2017–Present

- Evaluation of commercial and utility scale solar PV facilities to assess the quality of design, construction, and operation
- Engineering analysis and concise presentation of results to customers

Solar Energy Engineer (various progressive titles), North Carolina Solar Center/NC Clean Energy Technology Center, North Carolina State University, 2005–April, 2017

- Lead solar engineer at the Center (2008-2017)
- Conducted detailed PV + storage feasibility study for community solar project for a NC municipal utility
- Provided quality assurance and technical support to development of in-house training program of every stage of solar farm construction for a leading regional utility-scale photovoltaic EPC firm
- Guided design of prototype residential Plug and Play PV system and collected AHJ feedback (Department of Energy SunShot project)
- Co-led stakeholder process to develop Template Solar Development Ordinance for North Carolina
- Led design and development of ISO-17025 accredited solar thermal collector testing lab
- Designed and installed PV field performance monitoring system, conducted performance analysis
- Conducted renewable energy site assessments for commercial, industrial, and institutional clients
- Presented to local government officials, community leaders, and general public on solar energy
- Provided technical support to a wide variety of energy consumers and stakeholders across North Carolina

Consultant/Expert Witness, Private consultant for over 15 solar developer clients, 2012–Present

- Provides expert witness testimony at special/conditional use and re-zoning public hearings regarding the health, safety, and environmental impact of utility-scale solar photovoltaic systems. Experience in NC, SC, VA, and FL (over 60 projects to date)
- Provides respectful clear answers to sometimes ill-informed and/or hostile questions
- Conduct site-specific studies of EMF, sound, and solar glare hazard for several projects

Instructor of ET 220 Solar Photovoltaic Assessment, Department of Forestry and Environmental Resources, North Carolina State University, 2014–Present

- Developed all course content for this new three credit hour online course
- Course covers all aspects of photovoltaic site assessment including energy use, solar resource, system design, utility tariffs, estimating, economics, and more
- Course is optional course for an Environmental Technology and Management degree
- Course is required for a Renewable Energy Assessment minor

Instructor of MAE 421 Design of Solar Energy Systems, Mechanical and Aerospace Engineering Department of North Carolina State University, 2009-2014

- Instructor of the solar energy engineering course, MAE 421, in the NC State University Mechanical and Aerospace Engineering department
- The course was offered during the spring semester and typically had 30 to 50 undergraduate and up to twelve graduate engineering students
- Previously co-instructor of the course for two years (2007, 2009)

Research Assistant, North Carolina Solar Center, North Carolina State University, 2003–2005

- Developed and validated a TRNSYS simulation model of a unique solar thermal concentrating collector
- Assisted with the installation of photovoltaic systems ranging in capacity from 1 kW to 5 kW

Selected Publications

“Balancing Agricultural Productivity with Ground-Based Photovoltaic Development”, NCCETC/NCSU white paper, August 2017, <https://nccleantech.ncsu.edu/wp-content/uploads/Balancing-Ag-and-Solar-final-version-update.pdf>

“Health and Safety Impacts of Photovoltaics”, NCCETC/NCSU white paper, May 2017, https://nccleantech.ncsu.edu/wp-content/uploads/Health-and-Safety-Impacts-of-Solar-Photovoltaics-2017_white-paper-1.pdf

“Community Solar (+ Storage) Program Design for Fayetteville Public Works Commission”, NCSU/NCCETC report, March 2017, (Public version) https://nccleantech.ncsu.edu/wp-content/uploads/FPWC_CommunitySolar_Public_Version.pdf

T. Cleveland, H. Tsai, “Charlotte-Mecklenburg Schools Roadmap to 100% Renewable Electricity” & “Durham Public Schools Roadmap to 100% Renewable Electricity”, NCCETC, February 2016

T. Cleveland, et al, “Template Solar Energy Development Ordinance for North Carolina”, NCCETC & NCSEA, December 2013, www.go.ncsu.edu/template-solar-ordinance

M. Sheehan, T. Cleveland, “Updated Recommendations for Federal Energy Regulatory Commission Small Generator Interconnection Procedures Screens”, Solar America Board for Codes and Standards Study Report, 64 p., July 2010, www.solarabcs.org/about/publications/reports/ferc-screens/pdfs/ABCS-FERC_studyreport.pdf

T. Cleveland, et al, “Optimizing Solar Thermal Resource Use at Commercial Buildings”, Solar 2010 – ASES National Solar Energy Conference 2010, 6 p., May 2010, www.ases.org/papers/101.pdf

T. Cleveland, “Description and Performance of a TRNSYS Model of the Solargenix Tracking Power Roof™”, Solar 2005 – ASES National Solar Energy Conference, 6 p.

T. Cleveland, K. Creamer, & Dr. R. Johnson, “Energy Metering of Solar Domestic Hot Water Systems for Inclusion in Green Power and Renewable Portfolio Standards Programs”, Solar 2004 – ASES National Solar Energy Conference 2004, 6 p.

T. Cleveland, “Effective Energy Metering of Solar Domestic Hot Water Systems for Inclusion in Green Power and Renewable Portfolio Standards”, Master’s Thesis, North Carolina State University, Raleigh, 191 p., April 2004, <http://repository.lib.ncsu.edu/ir/handle/1840.16/1152>

Selected Recent Presentations

T. Cleveland, A. Huang, “Plug and Play Residential PV System Innovation and Demonstration”, Solar Power International Conference 2015

T. Cleveland, “Make Solar Energy Economical”, recorded video lecture for E102: Grand Challenges of Engineering course at NC State University, January 2015

T. Cleveland, M. Clark, “Template Solar Ordinance for North Carolina”, Solar Power International Conference 2014