

“F”

Biological Assessment

**BIOLOGICAL RESOURCES RECONNAISSANCE SURVEY REPORT
FOR THE
SOSCOL FERRY SOLAR PROJECT,
NAPA COUNTY, CALIFORNIA**

PREPARED FOR:

Wildcat Renewables, LLC
and
RP Napa Solar 2, LLC
655 Montgomery Street, Suite 1430
San Francisco, California 94111
Contact: Stephanie Loucas
(415) 710-3834

PREPARED BY:

Garcia and Associates
140 Diamond Creek Place
Roseville, California 95747
Contact: Susan Dewar
(530) 521-2385



August 2019

Contents

	Page
Summary.....	1
Introduction	2
Project Description.....	2
Background and Objectives	2
Site Location	2
Methods	6
Desktop Review.....	6
Definition of Special-status Species	6
Field Surveys.....	8
Results	10
Biological Setting	10
Existing Habitats	10
Upland Habitats.....	10
Aquatic and Riparian Habitats	11
Special-status Wildlife with Potential to Occur in the Project Area.....	13
Special-status Birds.....	14
Special-status Plants with Potential to Occur in the Project Area	16
Critical Habitat	17
Recommended Avoidance and Minimization Measures (AMMs).....	18
General Construction Measures	18
Measures for Birds.....	18
Measures for Special-status Plants and Vegetation Communities.....	20
Wetland and Water Feature Measures	20
References Cited	21

Figures

Figure 1. Project Location 3
Figure 2. Vegetation Map of Project Area 5
Figure 3. Special-status CNDDDB Occurrences Within 1-mile of the Project Area 7
Figure 4. Project Area Boundary and Survey Route 9
Figure 5. Biological Survey Results..... 12

Appendices

Appendix A Special-status Species Identified from Background Research
Appendix B Wildlife Species Observed in the Project Area
Appendix C Plant Species Observed in the Project Area
Appendix D Vegetation Features in the Biological Resource Evaluation Area
Appendix E Representative Photos of the Project Area
Appendix F Preliminary Layout

Acronyms and Abbreviations

Acronym/Abbreviation	Meaning
AC	Alternating Current
AMM	Avoidance and Minimization Measure
APN	Assessor's Parcel Number
BMP	Best Management Practice
BREA	Biological Resources Evaluation Area
CDFW	California Department of Fish and Wildlife
CEQA	California Environmental Quality Act
CESA	California Endangered Species Act
CNDDB	California Natural Diversity Database
CNPS	California Native Plant Society
CRPR	California Rare Plant Rank
DC	Direct Current
DPS	Distinct Population Segment
ESA	Federal Endangered Species Act
FGC	Fish and Game Code
ft	Foot or feet
GANDA	Garcia and Associates
GIS	Geographic Information System
GPS	Global Positioning System
IPaC	Information for Planning and Consultation
MCE	Marin Clean Energy
MCV	Manual of California Vegetation
MCV1	Manual of California Vegetation, first edition (Sawyer and Keeler-Wolf 1995)
MCV2	Manual of California Vegetation, second edition (Sawyer et al. 2009)
MW	Megawatt
NFD	No Formal Designation
NRCS	Natural Resources Conservation Service
NWI	National Wetlands Inventory
PG&E	Pacific Gas and Electric Company
PPA	Power Purchase Agreement
Project	Soscol Ferry Solar Project
Project Area	26 acres on APN 057-170-001-000 and the associated access road, located south of Soscol Ferry Road in Napa, California
quad	USGS 7.5-minute topographic quadrangle map
SR	State Route
USGS	U.S. Geological Survey
USFWS	U.S. Fish and Wildlife Service
WICC	Watershed Information and Conservation Council
WSS	Web Soil Survey

Soscol Ferry Solar Project

Biological Resources Reconnaissance Report

Summary

The Soscol Ferry Solar Project (Project) is a small-scale utility solar project proposed for construction on approximately 15-acres within a 26-acre (Project Area; defined as 22-acre parcel plus existing access road surveyed with 4-acre buffer) in Napa County, California. Garcia and Associates biologists conducted background research and field surveys in order to identify biological resources with the potential to be affected by Project construction. Wildlife habitat suitability surveys and floristic surveys were conducted for special-status wildlife and plant species as designated by the United States Fish and Wildlife Service, California Department of Fish and Wildlife, and California Native Plant Society, or otherwise considered rare or threatened in the region.

On July 17, 2019, a survey of the Project Area, including a buffer extending 500 feet around the Project Area, was conducted. The biological resources reconnaissance report considered the Project Area and buffer (approximately 118 acres), as well as a larger Biological Resources Evaluation Area consisting of the associated Napa River watershed (approximately 234,031 acres). While the parcel is zoned Industrial Park, habitats within the Project Area include Eucalyptus alliance, Valley Oak – Fremont Cottonwood – [Coast Live Oak] Riparian Forest No Formal Designation Association, and Upland Annual Grasslands and Forbs Formation, and Agriculture. The riparian woodland and the associated Suscol Creek are located on the northern boundary of the Project Area, where direct impacts will be avoided during Project construction and operation.

Special-status wildlife species and migratory birds were evaluated for their potential to occur and be affected by the Project. Based on the presence of suitable habitat, known occurrences, and observations during the survey, three of the 39 special-status wildlife species identified from desktop research are known to, or have potential to occur in the Project Area: golden eagle (*Aquila chrysaetos*, State fully protected), Swainson's hawk (*Buteo swainsoni*, State threatened), and white-tailed kite (*Elanus leucurus*, State fully protected). Of these three species, Swainson's hawk and white-tailed kite were observed during field surveys.

Seventeen special-status plant taxa were evaluated for their potential to occur and be affected by the Project. Of these, none have potential to occur within the Project Area based on absence of suitable habitat.

Based on the results of the site assessment, and with implementation of the proposed Avoidance and Minimization Measures, the Project is not expected to cause impacts to sensitive biological communities, special-status wildlife or plant species, or aquatic features.

Introduction

Project Description

The Soscol Ferry Solar Project (Project) is a small-scale utility solar project proposed for construction on approximately 15 acres of a 22-acre (ac) parcel of land (assessor's parcel number [APN] 057-170-001-000) south of Soscol Ferry Road in Napa County, California. RP Napa Solar 2, LLC has entered into a purchase agreement with the property owners (Kimbal Griggs Giles and Therese Blodgett-Giles) to facilitate the development of a small-scale, utility solar power generation facility.

The Project consists of two phases and will generate a total of approximately 2 megawatts (MW) alternating current (AC) (equivalent of 3.0 MW direct current [DC]) of clean, reliable solar energy when complete. The Project will interconnect to Pacific Gas and Electric Company's (PG&E's) pre-existing electrical distribution system located on-site. The power generated from this facility will be sold to Marin Clean Energy (MCE) through a long-term Power Purchase Agreement (PPA).

The Soscol Ferry Project will utilize approximately 7,840 solar modules and 16 string inverters which convert the sun's energy into useable AC power. Single axis tracking technology will be utilized to allow the modules to efficiently track the sun throughout the day and maximize the efficiency of solar collection. The modules will be mounted on a steel racking system, which will be anchored into the ground using driven steel piers. The overall height of the array will be no more than 8 feet (ft) tall.

Background and Objectives

The purpose of this biological resources reconnaissance report is to evaluate the potential for special-status species and sensitive habitats to occur and be affected by the Project. This assessment identifies the habitat types present on and adjacent to the site; any wildlife movement corridors on the site; potential for the presence of special-status wildlife and plant species; and additional wildlife or botanical surveys needed to determine the presence of special-status species and the effects of the proposed Project.

For this analysis, a desktop review was performed to assess the potential presence of special-status species and their habitats in the vicinity of the Project Area. This was followed by a floristic survey for special-status plants and a habitat-level reconnaissance survey for special-status wildlife. Based on the results, recommendations for further surveys and avoidance and mitigation measures (AMMs) are provided herein.

Site Location

The Project Area encompasses 26 ac in Napa County (Figure 1), consisting of a single parcel (APN 057-170-001-000, 22 ac) and the existing access road and survey buffer from the parcel north to Soscol Ferry Road (4 acres). The Project Area is located approximately 0.25 mile (mi) southwest of the State Route (SR) 221 and SR 12 interchange, within the Napa River watershed in the Napa-Sonoma-Russian River Valleys Ecoregion (Griffith et al. 2016). Field surveys focused on the Project Area; an additional 500 ft boundary around the Project Area was evaluated for special-status wildlife and plants (approximately 118 ac).

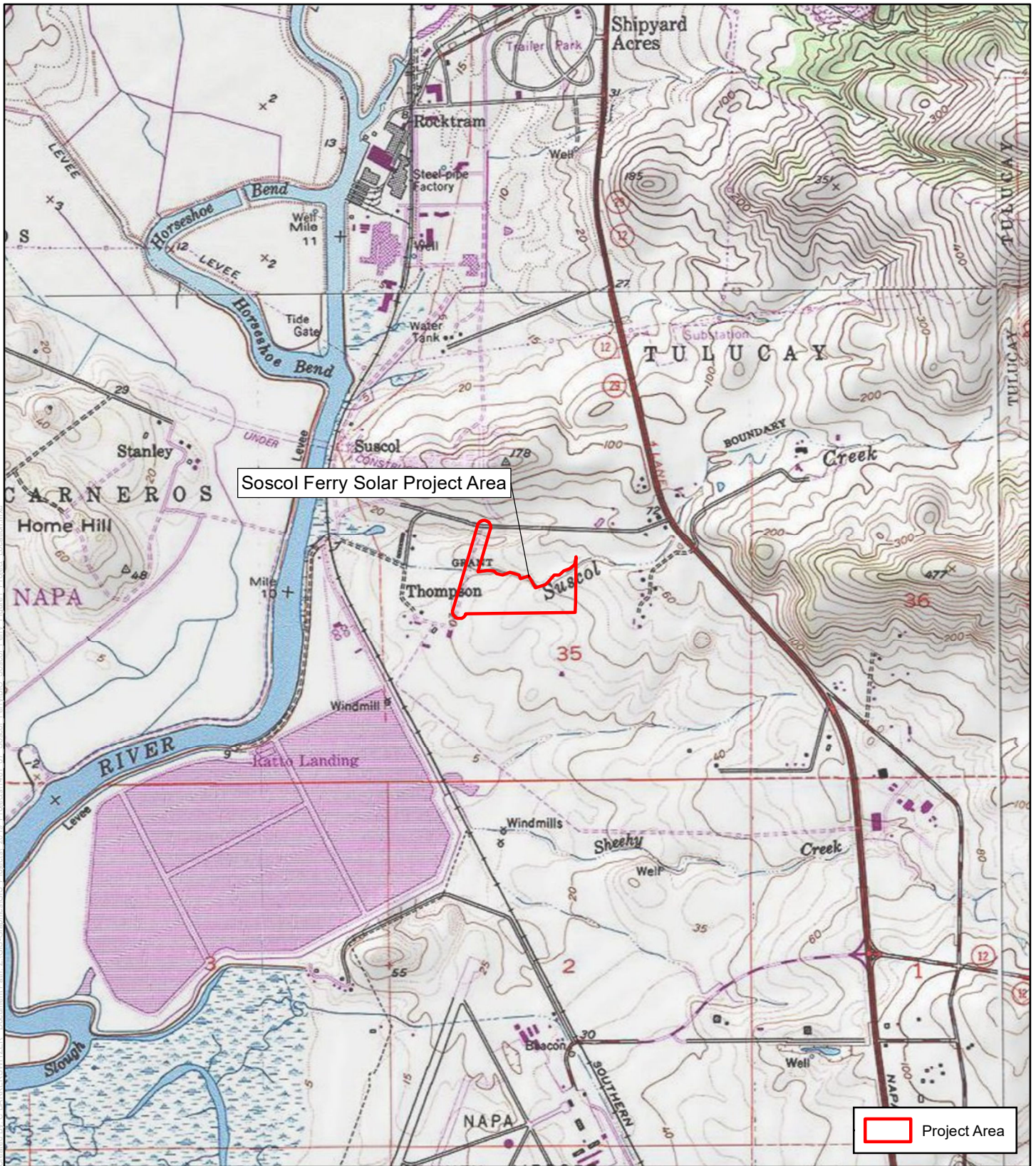

USGS 7.5' Quad: CUTTINGS WHARF (1981)

Legal Description: T05N, R04W, SEC 35

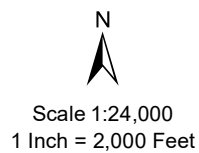
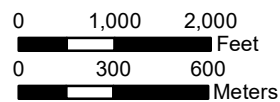

Figure 1. Project Location
 Soscol Ferry Solar Project
 Napa County, California
 August 2019



Habitat within a larger Biological Resources Evaluation Area (BREA) (all lands within 1.0 mi of the Project Area, and all lands in the Napa River watershed drainage [approximately 234,031 ac]) were also assessed.

The Project Area is currently being utilized as a vineyard that is parsed into three distinct plots (Figure 2). One plot covers the eastern portion of the Project Area, while the remaining two plots include the northwestern and southwestern areas of the vineyard. The northern boundary of the Project Area is approximately Suscol Creek and its surrounding riparian woodland. The western boundary of the Project Area is defined by a row of non-native/ornamental hardwood trees (*Eucalyptus* and *Robinia* species); there are no native trees within this row on the western boundary (Photo 1). The southern and eastern borders of the Project Area are defined by access roads separating the parcel from adjacent annual grassland (Photo 2 and Photo 3). The Project Area's eastern vineyard plot is divided from the northwestern and southwestern plots by an access road and another row of non-native/ornamental hardwood trees with two native oak trees that will be preserved (Photo 4 and Photo 5).

Two soil mapping units underly the Project Area: Bale clay loam and Cooms gravelly loam (NRCS 2019). Both soil types are characterized as loams.

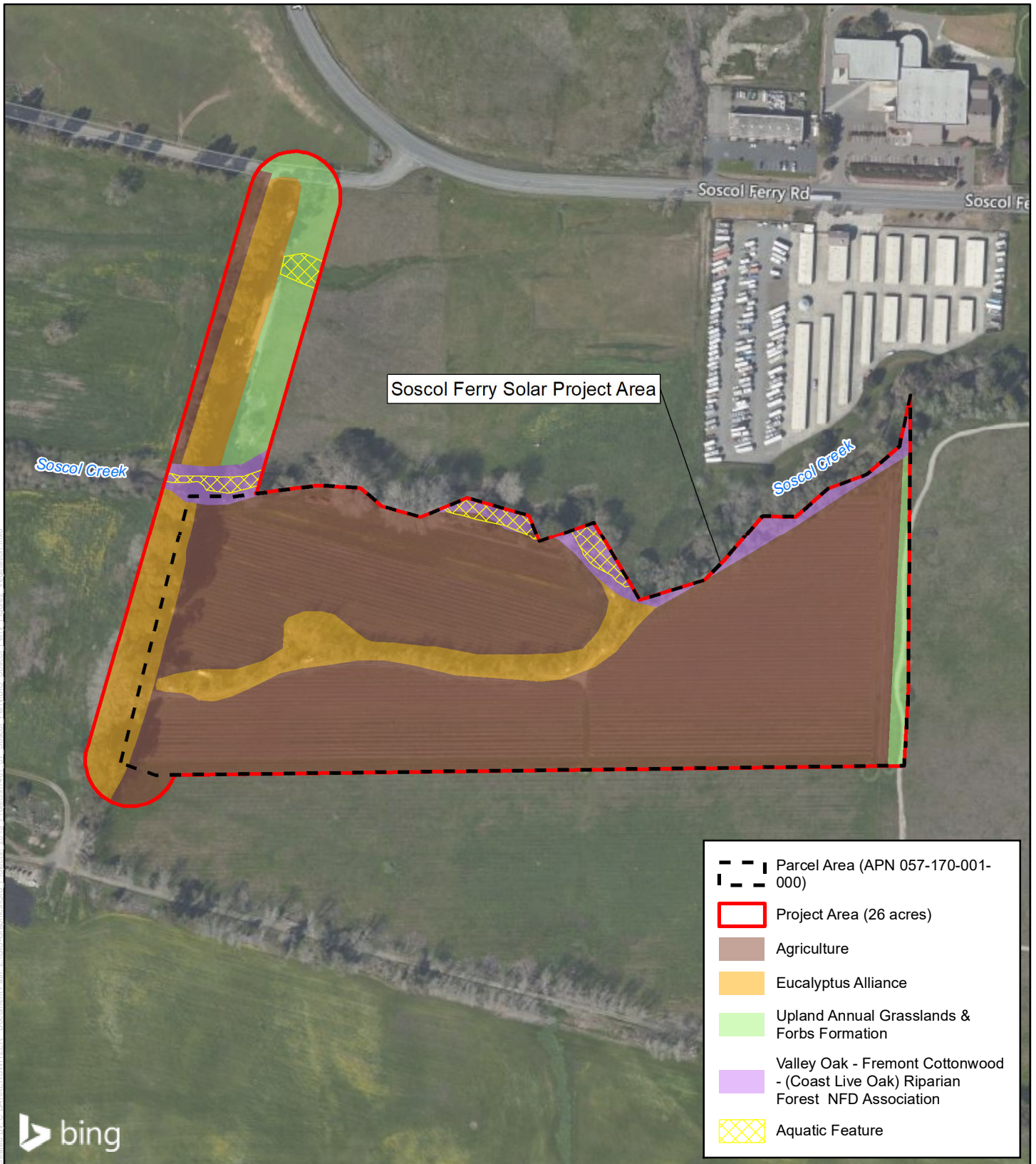

Source: Bing Aerial Hybrid; Ganda GIS 2019

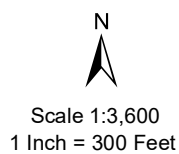

Figure 2. Vegetation Map of Project Area
 Soscol Ferry Solar Project
 Napa County, California
 August 2019



Methods

Desktop Review

Prior to field surveys, habitat types were reviewed using Napa County vegetation map data (M. Lamborn, Geographic Information Systems [GIS] Department Coordinator, pers. comm., March 2018 using Sawyer and Keeler-Wolf 1995¹). In addition, published information concerning special-status species that are known to, or have the potential to occur in the Project Area was collected from several sources and reviewed. Sources consulted included:

- The California Department of Fish and Wildlife's (CDFW's) California Natural Diversity Database (CNDDDB; CDFW 2019a);
- The California Native Plant Society's (CNPS's) Online Inventory of Rare and Endangered Vascular Plants of California (CNPS 2019);
- U.S. Fish and Wildlife Service (USFWS) Information for Planning and Consultation (IPaC) (USFWS 2019); and
- The Napa County Biological Resources Baseline Data Report (Watershed Information and Conservation Council [WICC] of Napa County 2005).

Queries of these databases were conducted for the United States Geological Survey (USGS) 7.5-minute quadrangle (quad) in which the site is located (*Cuttings Wharf, California*) and all directly-adjacent quads (nine-quad search) for wildlife and special-status plant species. The subset of the California Natural Diversity Database (CNDDDB) special-status occurrences located within 1.0 mi of the Project Area is presented in Figure 3. Information on reviewed species is presented in Appendix A. Background information regarding soil types (Web Soil Survey [WSS] NRCS 2019) and aquatic features (National Wetlands Inventory [NWI] USFWS 2019b) in the Project Area were also reviewed.

Definition of Special-status Species

Section 15380 of the California Environmental Quality Act (CEQA, September 1983) has a discussion regarding non-listed taxa. This section states that a plant or animal species must be treated as rare or endangered even if it is not officially listed. If a person or organization provides information showing that a taxon meets the State's definitions and criteria, then it should be treated as such. With this guidance in mind, the following definitions of special-status species are used in this analysis.

Special-status Wildlife Species

Special-status wildlife species include taxa designated as follows:

- Threatened, endangered, or candidate for listing under the Federal Endangered Species Act (ESA);
- Threatened, endangered, or rare under the California Endangered Species Act (CESA);

¹ Manual of California Vegetation (MCV), 1st edition (MCV1, Sawyer et al. 1995) is used rather than the more recent 2nd edition (MCV2, Sawyer et al. 2009) or online versions, because mapping for Napa County (WICC of Napa County 2005) utilizes Sawyer et al. 1995.

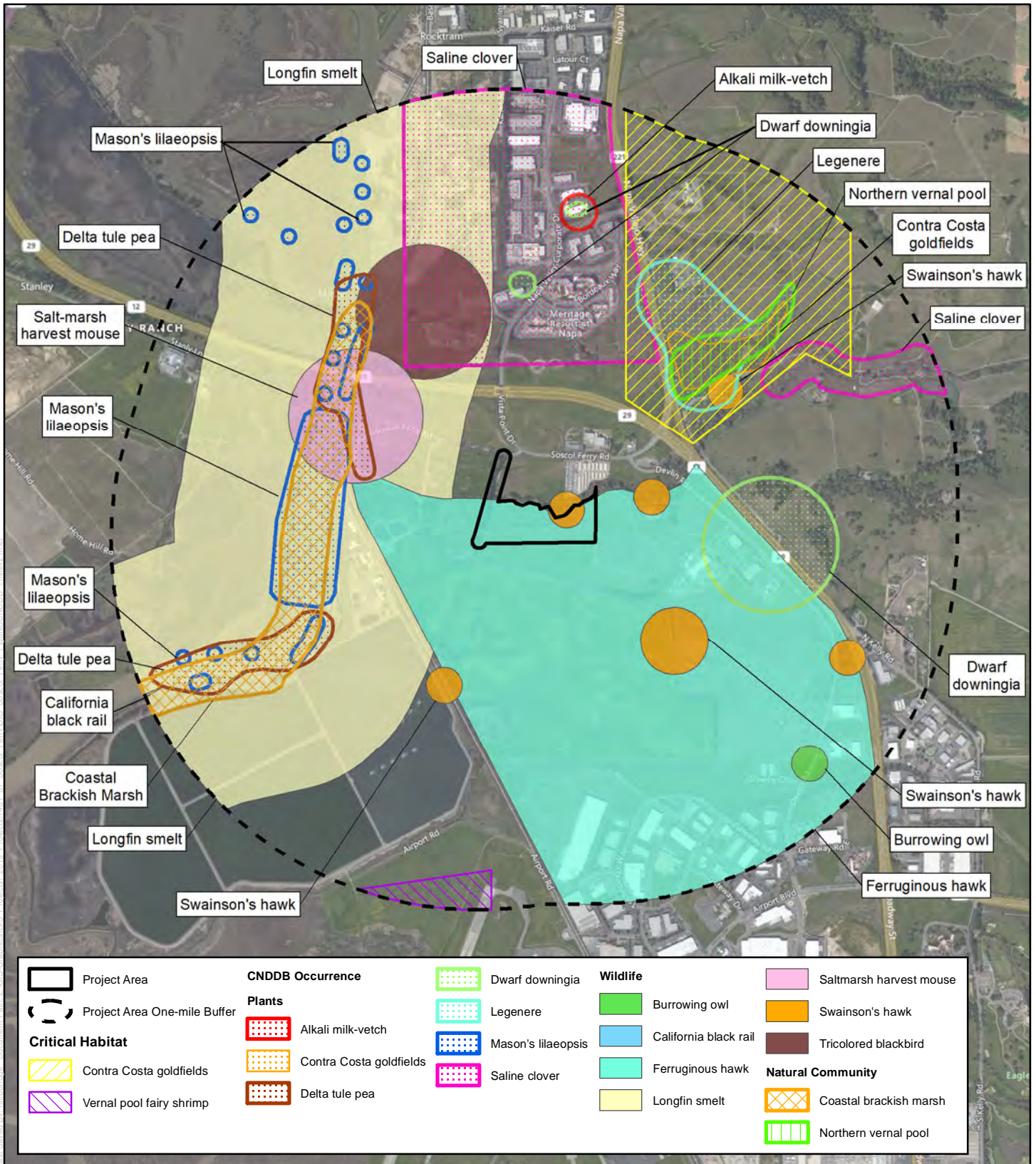

Source: CNDDB (August 2019); USFWS (2019)

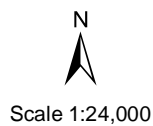
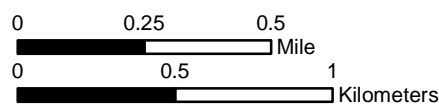

Figure 3. Special-status CNDDB Occurrences Within 1-mile of the Project Area
 Soscol Ferry Solar Project
 Napa County, California
 August 2019



- Fully protected species under the California Fish and Game Code (FGC) §3511 (birds), §4700 (mammals), §5050 (reptiles and amphibians), and §5515 (fish); and
- CDFW species of special concern or fully protected species.

Special-status Plant Species

Special-status plant species include taxa with the following designations:

- Threatened, endangered, or candidate for listing under the ESA;
- Threatened, endangered, or rare under the CESA; and/or
- California Rare Plant Ranks (CRPRs) as follows (CNPS 2019):
 - 1A – Plants presumed extinct in California;
 - 1B – Plants rare, threatened, or endangered in California and elsewhere;
 - 2 – Plants rare, threatened, or endangered in California, but more common elsewhere;
 - 3 – Plants about which more information is needed – a review list (if suitable habitat was present); and
 - 4 – Plants of limited distribution – a watch list (if suitable habitat was present).

Field Surveys

A field survey evaluating botanical and wildlife resources, including habitat suitability for special-status species and a floristic survey, was conducted on July 17, 2019, between the hours of 0800 and 1230. The survey was performed by Garcia and Associates (GANDA) biologist Justin Tortosa and GANDA botanist Steven Serkanic. This survey was performed by walking meandering transects to cover the full extent of the Project Area (Figure 4). Observations were made of current land use, nature and degree of existing disturbances, physical topography, site physiognomy (characteristic species and related features of the associated plant community or vegetation), current wildlife use, and presence or potential presence (permanent or transitional) of special-status wildlife. Adjacent parcels were evaluated for special-status taxa up to 500 ft outside the primary Project Area.

During the floristic botanical survey, all vascular plant species encountered were identified to the taxonomic rank necessary to determine conservation status (Appendix C). The *Jepson eFlora* (Jepson Flora Project 2019) was referenced for plant identification and nomenclature.

Resources of interest and survey transects were mapped with geographical positioning system (GPS) capable Apple iPad Mini devices equipped with 3meter-accurate GPS receivers running ESRI Collector for ArcGIS version 10.3.2 software.

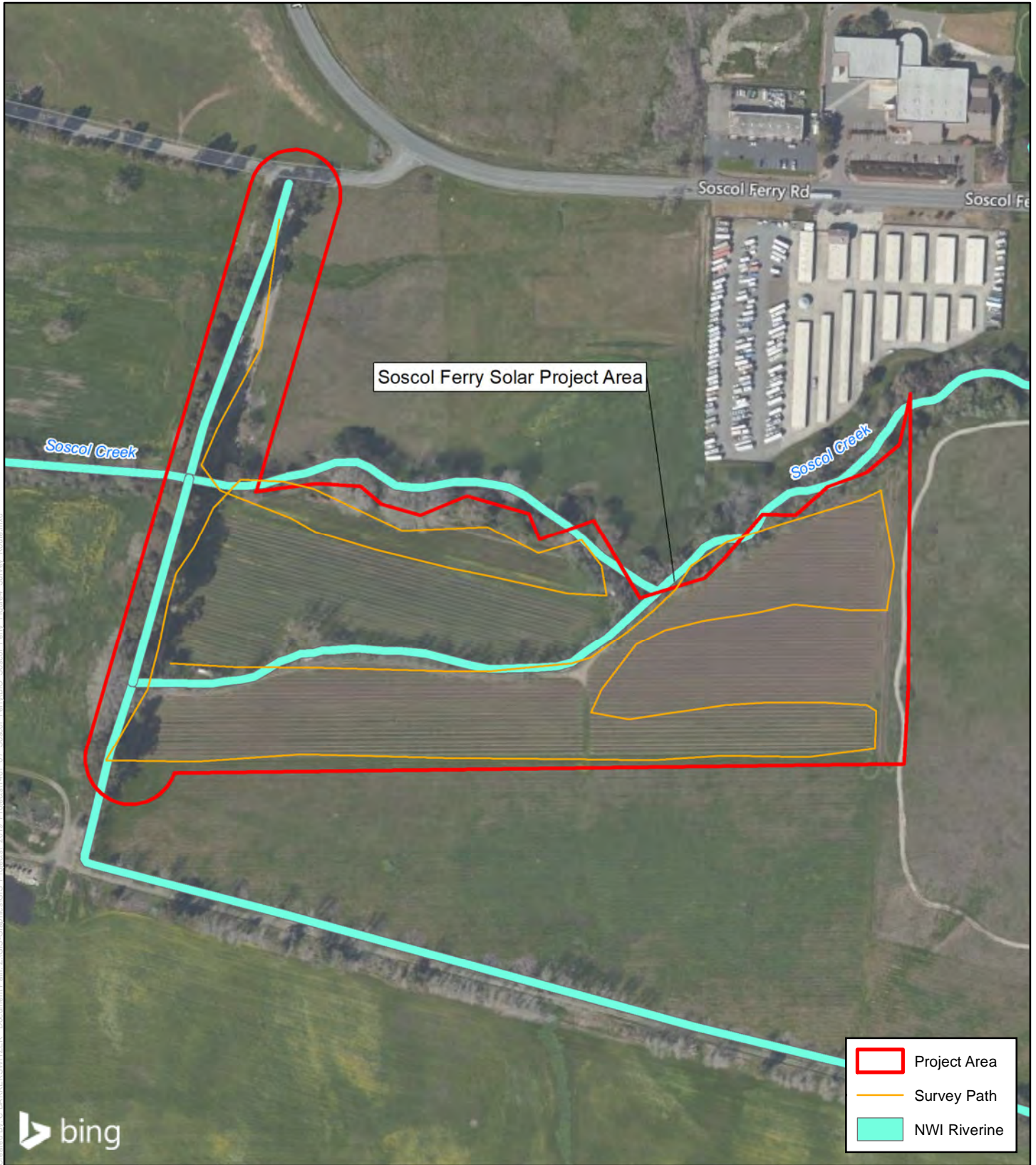

Created By: C:\BARKER\WITZEB... Document Path: Z:\GIS_Graphics\GIS_Projects_2019_Projects\14181_07_Soscol_Ferry\BIO_Soscol_Ferry_Equand_Survey_Route.mxd



Source: Bing Aerial Hybrid;
National Wetland Inventory (NWI); Ganda GIS 2019

0 150 300 Feet
0 50 100 Meters

N
Scale 1:3,600
1 Inch = 300 Feet

Figure 4. Project Area Boundary and Survey Route
 Soscol Ferry Solar Project
 Napa County, California
 August 2019



Results

Biological Setting

The BREA encompasses 59 of the 59 vegetation types within Napa County (WICC of Napa County 2005, and Appendix D). The Study Area is zoned Industrial Park; it is characterized by its flat topography dominated by current agricultural use (grape [*Vitis vinifera*] vineyard). The nearest aquatic resource feature is Suscol Creek (USFWS 2019b, Figure 1), located directly adjacent to the Project Area's northern boundary.

Existing Habitats

The Project Area supports four discrete vegetation types (Agriculture, Eucalyptus alliance, Valley Oak – Fremont Cottonwood – [Coast Live Oak] Riparian Forest No Formal Designation Association, and Upland Annual Grasslands and Forbs Formation). These types correspond with separate quantitatively circumscribed communities and distinct assemblages of plant species (Sawyer and Keeler-Wolf 1995).

Upland Habitats

Agriculture

A majority of the Project Area (19 ac) is occupied by agriculture habitat and used for production of wine grapes (Photo 6). Over 8,000 grape vines occupy this area (four varietals: ~6,000 chardonnay, ~2,000 pinot noir, ~300 zinfandel, and ~50 malbec) (K. Giles, property owner, pers. comm. 2019). Bindweed (*Convolvulus arvensis*), sharp leaved fluellin (*Kickxia elatine*), field marigold (*Calendula arvensis*), cultivated radish (*Raphanus sativus*), and turkey mullein (*Croton setiger*) also occur within vineyard grounds.

In the 1.0 mi surrounding the Project Area, 668 ac are mapped as agriculture vegetation. The entire BREA encompasses approximately 53,475 ac of this vegetation type.

Non-Native/Ornamental Hardwood Stands (Eucalyptus alliance)

Approximately 4.0 ac of the Project Area is occupied by non-native/ornamental hardwood stands of trees that can be classified as Eucalyptus alliance (Sawyer and Keeler-Wolf 1995) (Photo 1 and Photo 5). This alliance is generally used to describe non-native and ornamental trees in agricultural or urban settings. In the Project Area, these stands are dominated by black locust (*Robinia pseudoacacia*) and blue gum (*Eucalyptus globulus*), with oleander (*Nerium oleander*), and Italian stone pine (*Pinus pinea*) present in small numbers. In this habitat type, two native coast live oak trees (*Quercus agrifolia*) were also present (Figure 5).

In the 1.0 mi surrounding the Project Area, 13 ac of this vegetation type are present, and the entire BREA contains approximately 361 ac of Eucalyptus alliance in total.

During the field survey, some areas depicted in the NWI (USFWS 2019b) as riverine features were actually this upland vegetation type. The central row of trees separating the eastern vineyard plot from

the northwestern plot supports this upland vegetation type, and lacks characteristics indicative of wetland or aquatic conditions (Photos 4, 5, and 9).

Upland Annual Grasslands and Forbs Formation

Nearly 2.0 ac of the Project Area is vegetated with upland annual grassland and forbs formation (Photo 2 and Photo 3). Assorted bromes (*Bromus* spp.), oats (*Avena barbata*), curly dock (*Rumex crispus*), and Italian rye grass (*Festuca perennis*) dominate this vegetation type in the Project Area.

The broader region within 1.0 mi of the Project Area supports 431 ac of upland annual grassland and forbs formation, and the entire BREA contains approximately 5,855 ac in total.

Aquatic and Riparian Habitats

Seasonal Wetland

The existing access road passes a seasonal wetland occupying 0.11 ac of the Project Area (Figure 5). This wetland exhibits drainage-like features characteristic of habitat seasonally influenced by water (Photo 12).

The broader region within 1.0 mi of the Project Area supports 441 ac of similar freshwater wetland and aquatic habitat. The BREA itself contains roughly 7,462 ac in total.

No impacts to this aquatic feature type are expected as a result of Project construction or operation.

Intermittent Stream

Suscol Creek approximately parallels the northern boundary of the Project Area (Figure 4), and the top of bank (TOB) with and adjacent to the Project Area was mapped (Figure 5). Suscol Creek is a deeply incised intermittent stream. Approximately 0.44 ac and 620 linear ft of Suscol Creek is within the Project Area (but not within the area of the proposed solar array).

The broader region within 1.0 mi of the Project Area supports 441 ac of similar freshwater wetland and aquatic habitat. The BREA itself contains roughly 7,462 ac in total.

Stream setbacks outlined in Napa County's Water Quality and Tree Protection Ordinance (Napa County Board of Supervisors [NCBS] 2019) are measured from the TOB, and dependent on ground slope. The ground slope near the TOB is between 0 and 5 percent; per the ordinance, the setback from TOB is 35 ft in areas where the ground slope is less than 1 percent, and 45 ft in areas where the slope is 1 to 5 percent (NCBS 2019). This ordinance enhances stream, wetland, and municipal reservoir setbacks, while increasing tree canopy retention and preservation (NCBS 2019).

Suscol Creek, and the associated setbacks, will be avoided during Project construction and operation, and no impacts are expected to this creek. In general, the Project plans depict 150 ft stream setbacks in accordance with the Industrial Park Specific Plan (Appendix F).



Created By: C. BARBER/WITZEB. Document Path: Z:\GIS_Graphics\GIS_Productions_2019_Productions\1481_07_Soscol_Ferry\BIO_Soscol_Ferry_Equinox_Survey_Results.mxd



Source: Bing Aerial Hybrid; Ganda GIS 2019

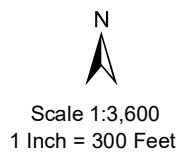
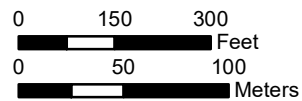

Figure 5. Biological Survey Results
 Soscol Ferry Solar Project
 Napa County, California
 August 2019



Riparian Woodland (Valley Oak – Fremont Cottonwood – [Coast Live Oak] Riparian Forest No Formal Designation Association)

The riparian woodland associated with Suscol Creek defines the northern boundary of the Project Area (Photo 7). The Project Area encompasses approximately 1.0 ac of riparian woodland classified as valley oak – Fremont cottonwood – (coast live oak) riparian forest no formal designation (NFD) association (Photo 8). Within the Project Area, the typical species of valley oak (*Quercus lobata*), Fremont cottonwood (*Populus fremontii*), and coast live oak were observed, along with, Pacific willow (*Salix lasiandra*), dotted smartweed (*Persicaria punctata*), tall cyperus (*Cyperus esculentus*), California buckeye (*Aesculus californica*), and lanceleaf water plantain (*Alisma lanceolatum*).

Within 1.0 mi of the Project Area, 23 ac of this vegetation type have been mapped, and the entire BREA supports approximately 407 ac in total.

The Project will avoid this vegetation type, and no impacts to riparian vegetation are anticipated during the course of this Project.

Special-status Wildlife with Potential to Occur in the Project Area

A review of special-status wildlife and their potential to occur in the Project Area, including status and habitats, is provided in Appendix A, Table 1. Thirty-nine special-status wildlife species were evaluated, seven of which have CNDDB occurrence records within a 1-mi radius of the Project Area (CDFW 2019a, Figure 3). Of those, three have reasonable potential to occur in the Project Area: Swainson's hawk (*Buteo swainsoni*) and white-tailed kite (*Elanus leucurus*) were observed and nesting was confirmed, and golden eagle (*Aquila chrysaetos*) has a high potential to occur. Life history accounts, significance, and potential impacts for these species are discussed below. Avoidance and Minimization Measures (AMMs) for species likely to occur or be impacted by the Project are discussed under AMMs.

No evidence of wildlife corridors was observed during the field survey, but active Swainson's hawk and white-tailed kite nests and small rodent (California ground squirrel [*Otospermophilus beecheyi*]) burrows are present. In addition, active tree swallow (*Tachycineta bicolor*) nests were observed in black locust trees along the Suscol Creek riparian corridor, and European starlings (*Sturnus vulgaris*) were nesting in the stand of trees dividing the northwestern vineyard plot from the southwestern and eastern plots. Tree swallow is a migratory bird with no special-status designation, while the European starling is an invasive species.

A list of 20 wildlife species observed in the Project Area during the field survey is provided in Appendix B.

Special-status Birds

Golden eagle (*Aquila chrysaetos*)

Federal Status: Unlisted.¹ State Status: Fully Protected.

The golden eagle is an uncommon permanent resident and migrant throughout California. This species inhabits a variety of habitats including forests, canyons, shrub lands, grasslands, and oak woodlands. Breeding occurs from late January through August. Nests are located in tall trees or cliffs usually adjacent to open areas (CDFW 2019b). Eggs are laid in early February to mid-May, with an incubation period of approximately 43-45 days. Clutch size is one to three eggs, with two eggs being typical (Zeiner et al. 1988-1990). Foraging habitat varies from grassland to oak woodland. The main prey species for golden eagles are Leporidae (hares and rabbits), but they will also take other mammals, birds, and reptiles. This species will also forage on carrion. Threats to golden eagles include loss of foraging areas and nesting habitat, urban development, pesticide poisoning, lead poisoning, and collision with man-made structures (CDFW 2019b).

According to the CNDDDB, a single occurrence of golden eagle is recorded within the nine-quad search area, but more than 1 mile west of the Project Area (CDFW 2019a). This occurrence describes the presence of birds at a nest from 2003 through 2005. In 2006, at that location, no nesting and an absence of birds at the nest was reported. In 2008, both the nest and nest tree were reported as removed. During the three years of occupancy only a single juvenile was reported. Golden eagles were not observed during the July, 17, 2019 biological survey of the Project Area.

The Project Area and surrounding parcels contain numerous large trees that could provide suitable nesting habitat for golden eagles. These large trees are most often associated with wind-breaks between agricultural fields and annual grasslands. Suitable foraging areas around the Project Area include open habitat such as annual grasslands and some of the agricultural areas, specifically those with low ground cover crops like alfalfa, cucumber, pumpkin, and pasture land. With the exception of access roads and unplanted areas, vineyards with grape vines supported 3-6 ft above the ground and arranged in long closely spaced rows do not provide open foraging habitat, and thus are unlikely foraging areas for golden eagles.

Conversion of the Project Area from its current use as a vineyard to solar energy production would not remove existing foraging habitat for the golden eagle. This conversion would result in a manmade cover type that is structurally similar to a vineyard. Rows of solar panels would be similar to elevated grape vines that conceal and provide cover, for small mammals, from raptors such as the golden eagle hunting from the wing.

If Project construction occurs during the nesting season (February 1 through August 31), implementation of AMMs such as nesting bird surveys prior to the start of construction is recommended. If necessary, seasonal buffers will be implemented to avoid disturbances to occupied nests. With implementation of these AMMs, direct impacts to golden eagles from Project construction and operation are not anticipated.

¹ Although not listed under the federal ESA, golden eagles are protected under the Bald and Golden Eagle Protection Act (16 U.S.C. 668-668c), as amended.

Swainson's hawk (*Buteo swainsoni*)

Federal Status: None. State Status: Threatened.

The Swainson's hawk occurs in riparian, agricultural, and grassland habitats throughout the Central Valley of California, extending westerly into Coast Range grasslands and agricultural areas surrounding the San Francisco Bay. Prey includes small mammals (e.g., mice, gophers, ground squirrels, and rabbits), amphibians, reptiles, birds, and occasionally fish (Zeiner et al. 1988-1990). Nests are a platform of sticks, typically constructed near riparian systems, and may occur in remnant riparian trees, planted windbreaks, shade trees at residences and along roadsides, and solitary upland oaks. Trees most commonly used for nesting include Fremont's cottonwood, willow (*Salix* sp.), sycamores (*Platanus* sp.), valley oak, and walnut (*Juglans* sp.); eucalyptus (*Eucalyptus* sp.), pine (*Pinus* sp.), and redwood (*Sequoia sempervirens*) also are used occasionally (Woodbridge 1998). Breeding occurs from late March to late August. Clutch size averages 2-3 eggs, and incubation takes 34-35 days (NatureServe 2018). Young leave the nest at about 30 days and attain flight 12-14 days later (NatureServe 2018).

According to the CNDDDB, six Swainson's hawk nests are located within 1 mi of the Project Area (Figure 3, CDFW 2019a). One of the CNDDDB reported nests is within the Suscol Creek riparian corridor on the northern border of the Project Area. During the July 17, 2019 biological survey, two adult and two recently fledged Swainson's hawks were present at the Project Area. The adults were observed in flight over, and perched at, various locations along the western border of the Project Area. The two recently fledged young were extremely vocal and remained in close proximity to a nest located in a eucalyptus tree at the northwest corner of the Project Area (Figure 5, Photo 10).

Regarding other CNDDDB nest occurrences within 0.5 mi of the Project Area, all nests reported within the Suscol Creek riparian corridor were not occupied. However, vocal Swainson's hawks were present southeast of the Project Area in the vicinity of one of the CNDDDB nests shown in Figure 3, indicating that the territory may be active.

The Project Area and surrounding parcels contain numerous large trees that could provide suitable nesting habitat. These large trees are most often associated with wind-breaks between agricultural fields and annual grasslands. Suitable foraging areas around the Project Area include open habitat such as annual grasslands and some of the agricultural areas, specifically those with low ground cover crops like alfalfa, cucumber, pumpkin, and pasture land. With the exception of access roads and unplanted areas, vineyards with grape vines supported 3-6 ft above the ground and arranged in long closely spaced rows do not mirror open foraging habitat, and thus would be unlikely foraging areas for Swainson's hawk.

Conversion of the Project Area from its current use as a vineyard to solar energy production would not remove existing foraging habitat for Swainson's hawk. This conversion would result in a manmade cover type that is structurally similar to a vineyard. Rows of solar panels would be similar to elevated grape vines that conceal and provide cover for small mammals from raptors, like the Swainson's hawk, hunting on the wing.

If Project construction occurs during the nesting season (February 1 through August 31), implementation of AMMs such as nesting bird surveys prior to the start of construction is recommended. If necessary, seasonal buffers will be implemented to avoid disturbances to occupied nests. With implementation of these AMMs, direct impacts to Swainson's hawks are not anticipated.

White-tailed kite (*Elanus leucurus*)

Federal Status: None. State Status: Fully Protected.

The white-tailed kite is a non-migratory occupant of California's coastal and valley lowlands that is rarely found away from agricultural areas. This is the only North American kite that hovers while hunting for prey; which consists of small rodents (especially voles), reptiles, insects, and small birds. Nests are constructed of loosely piled sticks and twigs, lined with grass, and placed near the top of trees. This species' home range may be as large as 3 square mi, with a mean breeding home range of 0.2 mi. White-tailed kites breed between February and October with an average clutch size of 4-5 eggs. Incubation takes about 28 days and young fledge 35-40 days thereafter (Zeiner et al. 1988-1990).

According to the CNDDDB, white-tailed kite occur within the nine-quad search area, but are located more than 1-mi north of the Project Area (CDFW 2019a). During the July 17, 2019 biological survey, two adult and one recently fledged white-tailed kite were present at the Project Area. One of the adults was observed actively hunting over the annual grassland east of the Project Area (annual grassland shown in Photo 3). The adult captured a small rodent, flew to a snag on the edge of the annual grassland and Suscol Creek, and consumed its prey. While consuming the rodent, a juvenile called continuously from the Suscol Creek riparian corridor, then flew to a tree adjacent to the adult and continued to beg for food. Following this interaction both the adult and juvenile returned to the suspected nest tree in the Suscol Creek riparian corridor where they were joined by a second adult (Figure 5).

The Project Area and surrounding parcels contain numerous large trees that could provide suitable nesting habitat. These large trees are most often associated with wind-breaks between agricultural fields and annual grasslands. White-tailed kite don't typically reuse nests, but may re-nest in the same general area if prey is abundant. Suitable foraging areas around the Project Area include open habitat such as annual grasslands and some of the agricultural areas, specifically those with low ground cover crops like alfalfa, cucumber, pumpkin, and pasture land. With the exception of access roads and unplanted areas, vineyards with grape vines supported 3-6 ft above the ground and arranged in long closely spaced rows do not mirror open foraging habitat, and thus would be unlikely foraging habitat for white-tailed kite.

Conversion of the Project Area from its current use as a vineyard to solar energy production would not remove existing foraging habitat for white-tailed kite. This conversion would result in a manmade cover type that is structurally similar to a vineyard. Rows of solar panels would be similar to elevated grape vines that conceal and provide cover for small mammals from raptors such as the white-tailed kite that hunt on the wing.

If Project construction occurs during the nesting season (February 1 through August 31), implementation of AMMs such as nesting bird surveys prior to the start of construction is recommended. If necessary, seasonal buffers will be implemented to avoid disturbances to occupied nests. With implementation of these AMMs, direct impacts to white-tailed kites are not anticipated.

Special-status Plants with Potential to Occur in the Project Area

Special-status plant taxa reviewed for this investigation, including listing status, habitats, and presence of suitable habitat in the Project Area, are identified in Appendix A, Table 2. The desktop review

identified 17 special-status plant taxa, of which seven of these have known CNDDDB occurrences (CDFW 2019a) within 1 mi of the Project Area (Figure 3): alkali milk-vetch (*Astragalus tener* var. *tener*), dwarf downingia (*Downingia pusilla*), Contra Costa goldfields (*Lasthenia conjugens*), Delta tule pea (*Lathyrus jepsonii* var. *jepsonii*), Legenere (*Legenere limosa*), Mason's lilaeopsis (*Lilaeopsis masonii*), and saline clover (*Trifolium hydrophilum*). These eight taxa lack suitable habitat within the Project Area (Appendix A, Table 2). The disturbed agricultural habitat in the Project Area, and absence of salt water marsh, vernal pools, and similar mesic habitats, do not provide suitable habitat for these special-status plant species.

Looking at the larger nine-quad search area, eight special-status plant taxa were determined to have a low probability of occurring in or within 500 ft of the Project Area (Appendix A, Table 2): Napa false indigo (*Amorpha californica* var. *napensis*), big tarplant (*Blepharizonia plumosa*), western leatherwood (*Dirca occidentalis*), Jepson's coyote-thistle (*Eryngium jepsonii*), congested-headed hayfield tarplant (*Hemizonia congesta* ssp. *congesta*), woolly-headed lessingia (*Lessingia hololeuca*), Napa bluecurls (*Trichostema ruygtii*), and two-fork clover (*Trifolium amoenum*). The disturbed annual grasslands and riparian woodlands in the Project Area provide only marginally suitable habitat for these eight species. None of these taxa were observed on site. In addition, related taxa and other native taxa with similar life history characteristics were not present in the Project Area, lending further support for the absence of these plants.

Not all plant species may have been in a suitable condition to determine status. However, the botanical survey (July 2019) took place during a period of the season when many targeted special-status plants were at peak development and the chance of locating special-status botanical resources was maximized. The field survey determined that habitats within the Project Area are only minimally suitable for special-status plants, and therefore special-status plant taxa known from the region are not expected to occur in the Project Area or be impacted by proposed Project activities. No further special-status plant surveys are recommended.

Critical Habitat

No designated critical habitat for federally listed species occurs within the Project Area or the surrounding 500 ft buffer, and no critical habitat will be affected by proposed Project activities.

Recommended Avoidance and Minimization Measures (AMMs)

The following AMMs will be implemented to limit impacts to biological resources:

General Construction Measures

1. Prior to working on the Project, all Project personnel will attend a preconstruction environmental training to review potential special-status wildlife that could be found in the Project Area and ensure that AMMs for the Project are understood and implemented.
2. Work areas, staging areas, and access roads will be limited to those shown in the final Project description. All heavy equipment, vehicle, and construction activities will be confined to these designated areas.
3. All trash and waste items generated by construction or crew activities will be properly contained and removed from the Project Area.
4. All Project personnel will visually check for animals beneath vehicles and equipment immediately prior to operation. Any pipes, culverts, or other open-ended materials and equipment stored on-site for one or more overnight periods will be inspected for animals prior to moving, burying, or capping to assure that no animals are present within the materials and equipment.
5. To prevent accidental entrapment of wildlife during construction, all excavated holes, ditches, or trenches greater than 1-ft-deep will be covered at the end of each work day by suitable materials, or escape routes will be constructed. After opening, and before filling such holes, ditches, and trenches will be thoroughly inspected for trapped animals.
6. If a special-status species is discovered in the Project Area, the Project Manager will be contacted. The Project Manager will report the sighting to the appropriate natural resource agency(ies) (e.g., CDFW, USFWS) within 24 hours. The animal will be allowed to move off-site on its own. Special-status species will not be taken or harassed.
7. A copy of all applicable permits and approvals, with associated maps, conditions, and AMMs will be kept on-site at all times.

Measures for Birds

All migratory birds are protected under the Migratory Bird Treaty Act. A number of migratory birds were observed in the Project Area, and may utilize structures, trees and other vegetation, or pastureland for nesting.

All trees and vegetation have the potential to be active nest sites for a number of avian species. Tree and vegetation removal could potentially impact nesting migratory birds if conducted during the nesting season (February 1-August 31).

8. If feasible, Project activities should be scheduled outside of the nesting bird season, in order to avoid impacts to nesting migratory birds of all types.

9. **A nesting bird survey is not required for construction activities that occur outside the nesting season (from September 1 through January 31).** In the event that construction activities (e.g., vegetation removal, ground disturbing activities [pile driving, trenching, inverter pad installation, and access road construction], assembly of solar array, other use of heavy equipment, etc.) begin within the nesting bird season, a qualified biologist will conduct preconstruction surveys for nesting birds. In the event that construction starts outside of the nesting season (February 1 – August 31) and continues continuously (as defined as no more than 14 days break between work), then a nesting bird survey is not required at any point throughout construction. Under this scenario, a nesting bird survey is only required if construction ceases for 14 days or longer in a row during the nesting season.

For construction activities planned within the nesting season (February 1 to August 31), the nesting bird survey methods and the number of visits recommended are dependent on the construction schedule (i.e., construction starts before July 15 or after July 15) and the species that have the potential to be affected. The first survey scenario (a. below) is specific to Swainson's hawk (but will also cover all other nesting birds), and the second scenario (b. below) is inclusive of all nesting birds.

- a. **Construction activities planned between April 1 and July 15:** Swainson's hawk are migratory raptors that return to their California territories in April. This species has a historic and continued presence in and adjacent to the Project Area. If construction is scheduled to begin between April 1 and July 15, a survey for active Swainson's hawk territories/nests within a 1-mi radius of the Project Area is recommended. This survey includes three visits, with the first occurring in April, which coincides with the species arrival and nest construction. This survey will be used to determine territory occupancy. To confirm territory occupancy and nesting status, a second visit is recommended for the month of May, which coincides with egg laying and incubation. The second survey will be used to determine fledging of young. For reference, incubation lasts up to 35 days, and fledging occurs 44 days after hatching. A third visit will be performed no more than 14 days prior to the start of construction to determine if the young have fledged. During this follow-up survey, all suitable nesting habitat within and adjacent to the Project Area will be surveyed for active nests of other species.
 - b. **Construction activities planned between February 1 and March 31 or between July 16 and August 31:** If construction is scheduled to begin after July 15, a single preconstruction nesting bird survey shall be conducted no more than 14-days prior to the start of Project activities. If, during the nesting season, construction activities begin and then are stopped and remain stopped for 14 days or more, then the single preconstruction nesting bird survey shall be repeated.
10. If an active nest or nests are found, a qualified biologist will determine appropriate avoidance buffers and may monitor associated Project activities. Bird species that may be present, and appropriate avoidance buffers include the following:
- a. Golden eagle – 2,640 ft (0.5 mi);
 - b. Swainson's hawk – 1,320 ft (0.25 mi);
 - c. White-tailed kite – 500 ft;
 - d. Other raptors – species dependent, but generally between 200 and 300 ft; and

- e. Passerines (e.g., sparrow, swallow, robin) and other small birds – species dependent, but range between 50-100 ft.

Measures for Special-status Plants and Vegetation Communities

- 11. No known occurrences of special-status plant taxa occur at this time. However, if special-status plants are found, the Project Manager will be notified. Individuals will be marked (e.g., with flagging or construction fencing) and avoided during construction activities. Environmental training for construction personnel will include identification and location of on-site special-status plants.

Wetland and Water Feature Measures

- 12. Complete avoidance of Suscol Creek and associated riparian woodland along the northern boundary of the Project is planned. Plans call for a typical setback of 150 ft (Appendix F), and a minimum setback of 35-45 ft is required, depending on slope (NCBS 2019). The setback from Suscol Creek will be demarcated by fencing, flagging, or other highly visible material.
- 13. Extreme caution will be exercised when using the access bridge crossing Suscol Creek (Photo 11). When handling and/or storing chemicals (fuel, hydraulic fluid, etc.) near waterways, all applicable laws/regulations and best management practices (BMPs) will be followed. Appropriate materials will be kept on site to prevent and manage spills. All construction equipment will be well maintained to prevent fuel, lubricants, or other fluid leaks. Equipment, when not in use, will be stored in upland areas outside of the boundaries of the stream-channel or other water bodies.
- 14. Erosion, sediment, and material stockpile BMPs will be employed between work areas and adjacent wetlands or waterways. No fill or runoff will be allowed to enter wetlands or waterways.
- 15. Any erosion and sediment control materials (e.g., hay bales, straw wattles, erosion blankets, etc.) will not include micro-filament netting, to avoid entrapment of wildlife. Any straw erosion and sediment control materials will be composed of certified weed free material.

References Cited

- California Department of Fish and Wildlife (CDFW). 2019a. RareFind 5 Version 5.2.14 <https://map.dfg.ca.gov/rarefind/view/RareFind.aspx>. Accessed July 2019.
- California Department of Fish and Wildlife (CDFW). 2019b. Golden Eagles in California. Accessed online on February 25, 2019 at <https://www.wildlife.ca.gov/Conservation/Birds/Golden-Eagles>.
- California Native Plant Society (CNPS). 2019. Inventory of Rare and Endangered Plants of California (online edition, v8-03 0.39) from the CNPS Rare Plant Program. Website <http://www.rareplants.cnps.org>. Accessed online 15 2019.
- Griffith, G.E., Omernik, J.M., Smith, D.W., Cook, T.D., Tallyn, E., Moseley, K., and Johnson, C.B., 2016. Ecoregions of California: U.S. Geological Survey Open-File Report 2016–1021, with map, scale 1:1,100,000. Accessed online at <http://dx.doi.org/10.3133/ofr20161021>.
- Jepson Flora Project (eds.) 2019. *Jepson eFlora*. Accessed online on July 15, 2019 at <http://ucjeps.berkeley.edu/eflora>.
- Lichvar, R.W., D.L. Banks, W.N. Kirchner, and N.C. Melvin. 2016. The National Wetland Plant List: 2016 Wetland Ratings. *Phytoneuron* 2016-30: 1-17. Published 28 April 2016.
- Napa County Board of Supervisors (NCBS). 2019. Water Quality and Tree Protection Ordinance. County of Napa, CA. <https://www.countyofnapa.org/2526/Water-Quality-and-Tree-Protection-Ordina>.
- National Resource Conservation Service (NRCS). 2019. Web Soil Survey (WSS). Area around the Project Area, Napa County, California. Accessed online at <http://websoilsurvey.sc.egov.usda.gov/App/WebSoilSurvey.aspx> on July 15, 2019.
- NatureServe. 2018. NatureServe Exploer: an Online Encyclopedia of Life [web application]. Version 7.1. NatureServe, Arlington, Virginia. Accessed online on July 12, 2019 at <http://explorer.natureserve.org>.
- Sawyer, J.O. and T. Keeler-Wolf 1995. A Manual of California Vegetation, 1st edition. California Native Plant Society, Sacramento, CA.
- Sawyer, J.O., T. Keeler-Wolf, and J.M. Evens. 2009. A Manual of California Vegetation, Second Edition. California Native Plant Society, Sacramento, CA. 1300 pp.
- U.S. Fish and Wildlife Service (USFWS). 2019a. Information for Planning and Consultation (IPaC) website. Accessed online at <https://ecos.fws.gov/ipac/> on July 10, 2015.
- U. S. Fish and Wildlife Service (USFWS). 2019b. National Wetlands Inventory website. U.S. Department of the Interior, Fish and Wildlife Service, Washington, D.C. Accessed online on July 15, 2019 at <http://www.fws.gov/wetlands/>.
- Watershed Information & Conservation Council (WICC) of Napa County. 2005. Baseline Data Report, Chapter 4, Biological Resources. Accessed online at https://www.napawatersheds.org/app_pages/view/192. Accessed on July 15, 2019.
- Woodbridge, B. 1998. Swainson's Hawk (*Buteo swainsoni*). The Riparian Bird Conservation Plan: a strategy for reversing the decline of riparian-associated birds in California. California

Partners in Flight. Accessed online on July 12, 2019 at http://www.prbo.org/calpif/htmldocs/riparian_v-2.html.

Zeiner, D.C., W.F. Laudenslayer, Jr., K.E. Mayer, and M. White eds. 1988-1990. California's Wildlife. Vol I-III. California Department of Fish and Game, Sacramento, California. Accessed online on February 25, 2019 at <https://nrm.dfg.ca.gov/FileHandler.ashx?DocumentID=1681&inline=1>.

PERSONAL COMMUNICATIONS

Lamborn, Matt, GIS Department Coordinator, email communication with Garcia and Associates GIS Specialist. March 2018.

Giles, Kimbal, property owner, in-person communication with Garcia and Associates biologists. July 2019.

Appendix A

Special-status Species Identified from Background Research

Table 1. Special-status Wildlife Identified from Background Research

NAME	STATUS ¹	HABITAT	POTENTIAL FOR OCCURRENCE IN PROJECT AREA ²
Invertebrates			
Vernal pool fairy shrimp <i>Branchinecta lynchi</i>	FT	Inhabits seasonal wetlands in California's Central Valley and coastal mountains.	No Potential. No suitable habitat present. No known occurrences documented in the CNDDDB within 1.0 mile (mi) of the Project Area. Species not observed.
Conservancy fairy shrimp <i>Branchinecta conservatio</i>	FE	Inhabits rather large, cool-water vernal pools with moderately turbid water.	No Potential. No suitable habitat present. No known occurrences documented in the CNDDDB within 1.0 mi of the Project Area. Species not observed.
California freshwater shrimp <i>Syncaris pacifica</i>	FE, SE	Found only in low-elevation (less than 380 feet [ft]) and low-gradient (generally less than 1 percent) perennial coastal streams. Streams are generally 12-36 inches (in) in depth, with exposed live roots along undercut banks. Feeds on detritus.	No Potential. No suitable habitat present. No known occurrences documented in the CNDDDB within 1.0 mi of the Project Area. Species not observed.
Valley elderberry longhorn beetle <i>Desmocerus californicus dimorphus</i>	FT	Typically occurs at elevations below 3,000 ft and is almost always found on elderberry shrubs, its host plant that are greater than 1-in diameter at ground level. Also, closely associated with riparian habitat.	No Potential. Outside of species range. No documented occurrences are noted on CNDDDB within 1.0 mi of the Project, but a single elderberry shrub greater than 1-in diameter is located in the Suscol Creek riparian woodland corridor. Napa County is not known to be within the range of this species, and because of the isolation of the shrub and distance to the riparian habitat, the species likely has low potential to occur. Species not observed.
San Bruno elfin butterfly <i>Callophrys mossii bayensis</i>	FE	Inhabits rocky outcrops and cliffs in coastal scrub on the San Francisco peninsula. <i>Sedum spathulifolium</i> is the host plant for larvae, and adults feed on flower nectar from their host plant and others.	No Potential. No suitable habitat present. No known occurrences documented in the CNDDDB within 1.0 mi of the Project Area. Species not observed.

NAME	STATUS ¹	HABITAT	POTENTIAL FOR OCCURRENCE IN PROJECT AREA ²
Callippe silverspot butterfly <i>Speyeria callippe callippe</i>	FE	Associated with grassland habitats of San Mateo, Alameda, and Sonoma counties and the hills between Vallejo and Cordelia, California. <i>Viola pedunculata</i> is the host plant for larvae, and adults feed on flower nectar from several plant species.	No Potential. No suitable habitat present. No known occurrences documented in the CNDDDB within 1.0 mi of the Project Area. Species not observed.
Fish			
Steelhead – central California coast distinct population segment (DPS) <i>Oncorhynchus mykiss irideus</i>	FT	Steelhead are an anadromous fish that spends most of its life in the ocean, returning to freshwater to breed before returning to the ocean. The central California coast distinct population segment includes all naturally spawned populations of steelhead in streams from the Russian River to Aptos Creek in Santa Cruz County, and also includes the drainages of San Francisco and San Pablo bays.	No Potential. No suitable habitat present. No known occurrences documented in the CNDDDB within 1.0 mi of the Project Area. Species not observed.
Delta smelt <i>Hypomesus transpacificus</i>	FT, SE	Found in the San Francisco Estuary and the Sacramento/San Joaquin Delta.	No Potential. No suitable habitat present. No known occurrences documented in the CNDDDB within 1.0 mi of the Project Area. Species not observed.
Longfin smelt <i>Spirinchus thaleichthys</i>	FC, ST	Found in the San Francisco Estuary and the Sacramento/San Joaquin Delta.	No Potential. No suitable habitat present. One known occurrence documented in the CNDDDB within 1.0 mi of the Project Area. Species not observed.
Sacramento splittail <i>Pogonichthys macrolepidotus</i>	SSC	Found in estuarine environments, typically in water with salinities between 10 and 18 parts per trillion, and with temperatures between 5-24 degrees Celsius. Well suited for slow moving rivers, sloughs, and alkaline lakes.	No Potential. No suitable habitat present. No known occurrences documented in the CNDDDB within 1.0 mi of the Project Area. Species not observed.
Tidewater goby <i>Eucyclogobius newberryi</i>	FE	Inhabits brackish water in shallow lagoons and in lower stream reaches where water is fairly still but not stagnant.	No Potential. No suitable habitat present. No known occurrences documented in the CNDDDB within 1.0 mi of the Project Area. Species not observed.

NAME	STATUS ¹	HABITAT	POTENTIAL FOR OCCURRENCE IN PROJECT AREA ²
Amphibians			
Red-bellied newt <i>Taricha rivularis</i>	SSC	Primarily inhabits redwood forests, but found within mixed conifer, valley-foothill woodland, montane hardwood, and hardwood conifer habitats. Migrates to streams during fall and winter rains. Spends dry season underground. Rapid-flowing permanent streams are required for breeding and larval development.	No Potential. No suitable habitat present. No known occurrences documented in the CNDDDB within 1.0 mi of the Project Area. Species not observed.
California giant salamander <i>Dicamptodon ensatus</i>	SSC	Occurs up to 6,500 ft primarily in humid coastal forests, especially in Douglas fir, redwood, red fir, and montane and valley-foothill riparian habitats. Lives in or near cold flowing streams. Terrestrial adults are found under surface litter and in tunnels. Eggs are deposited in spring, several feet below the surface in cold, slowly flowing water in springs, channels, under streambanks, and beneath rocks and coarse woody debris in stream bottoms during the spring.	No Potential. No suitable habitat present. No known occurrences documented in the CNDDDB within 1.0 mi of the Project Area. Species not observed.
California red-legged frog <i>Rana draytonii</i>	FT SSC	Requires specific aquatic and upland habitat resources and can travel up to 2.0 mi from suitable breeding sites. Aquatic habitat consists of slow moving streams, ponds or drainages, and breeding sites typically occur in deep (greater than 2.5 ft) slow moving or still pools. Prefers upland habitat that stays cool during summer and features suitable shelter such as logs, dense vegetation, burrows and manmade structures (culverts, boxes, etc.).	No Potential. No suitable habitat present. No known occurrences documented in the CNDDDB within 1.0 mi of the Project Area. Species not observed.
Foothill yellow-legged frog <i>Rana boylei</i>	SCT, SSC	Inhabits rocky streams from near sea level to over 6,300 ft. Breeding and egg laying occurs at the end of spring and is triggered by water conditions. Egg masses are attached to gravel or rocks in moving water near stream margins.	No Potential. No suitable habitat present. No known occurrences documented in the CNDDDB within 1.0 mi of the Project Area. Species not observed.
Reptiles			
Green sea turtle <i>Chelonia mydas</i>	FT	Generally found nearshore as well as in bays and lagoons on reefs. Hatchlings live in the open ocean for several years, returning to nearshore foraging grounds.	No Potential. No suitable habitat present. No known occurrences documented in the CNDDDB within 1.0 mi of the Project Area. Species not observed.

NAME	STATUS ¹	HABITAT	POTENTIAL FOR OCCURRENCE IN PROJECT AREA ²
Western pond turtle <i>Emys marmorata</i>	SSC	Associated with permanent ponds, lakes, streams, irrigation ditches or permanent pools along intermittent streams.	No Potential. No suitable habitat present. No known occurrences documented in the CNDDDB within 1.0 mi of the Project Area. Species not observed.
Alameda whipsnake <i>Masticophis lateralis euryxanthus</i>	FT, ST, SSC	Typically found in chaparral – northern coastal sage scrub and coastal sage. Utilizes grassland habitats during mating season. Generally retreats in November into hibernaculum and emerge in March.	No Potential. No suitable habitat present. No known occurrences documented in the CNDDDB within 1.0 mi of the Project Area. Species not observed.
Birds			
Golden eagle <i>Aquila chrysaetos</i>	FP	Known to inhabit a variety of habitats including forests, canyons, shrub lands, grasslands, and oak woodlands. Nests in tall trees or cliffs usually adjacent to open areas. Foraging habitat varies from grassland to oak woodland.	High. Suitable habitat present. No CNDDDB occurrence documented within 1.0 mi of the Project Area. Numerous large trees suitable for nesting are present along the western Project Area boundary and scattered throughout adjacent parcels. Foraging habitat also present on adjacent parcels. Species not observed.
Swainson's hawk <i>Buteo swainsoni</i>	ST	Nests in open riparian habitat, in scattered trees or small groves in sparsely vegetated flatlands. Forages in adjacent grasslands, suitable agricultural fields or livestock pastures. Eats mice, gophers, ground squirrels, rabbits, large arthropods, amphibians, reptiles, and birds.	Present. Six CNDDDB occurrences documented within 1.0 mi of the Project Area. Two vocal recently fledged Swainson's hawks were present in the northwest corner of the Project Area; they remained in close proximity to a large stick-nest near the top of a large eucalyptus tree, which is presumed to be their 2019 nest. Additional adults were observed in flight over and around the Project Area. Species observed.
Northern harrier <i>Circus hudsonius</i>	SSC	Habitat includes meadows, grasslands, open rangelands, desert sinks, fresh and saltwater emergent wetlands. Nests on ground in shrubby vegetation, usually at marsh edge. Forages mostly on voles, and other small mammals, birds, frogs, small reptiles, crustaceans, and insects.	Low. Minimal Suitable Habitat Present. No CNDDDB occurrences documented within 1.0 mi of the Project Area. Suitable nesting habitat absent, but potential foraging habitat present in adjacent parcels. One adult was observed in flight above the Project Area, but was promptly chased away by an adult Swainson's hawk. Species observed.

NAME	STATUS ¹	HABITAT	POTENTIAL FOR OCCURRENCE IN PROJECT AREA ²
White-tailed kite <i>Elanus leucurus</i>	FP	Occurs in open woodlands, grasslands, marshes and agricultural areas. Typically forages over lightly grazed fields. Nests in a variety of trees, typically in the upper third of the canopy.	Present. No CNDDDB occurrences documented within 1.0 mi of the Project Area. Two adults were actively foraging in annual grassland immediately east of the Project Area. A recently fledged white-tailed kite was observed making short flights along the Suscol Creek riparian corridor and vocally begging for food. Species observed.
American peregrine falcon <i>Falco peregrinus</i>	FP	Breeds mostly in woodland, forest, and coastal habitats. Riparian areas and coastal and inland wetlands are important habitats yearlong, especially in nonbreeding seasons. Typically nests on cliffs and ledges, occasionally in trees. Forages in flight.	Low. Minimal suitable habitat present. Suitable cliff nesting habitat is not present in the Project Area; however, suitable cliffs and nesting habitat occur in other areas in Napa County. No CNDDDB occurrence is within 1.0 mi of the Project Area. Due to the absence of suitable nesting habitat, American peregrine falcon may pass through the Project Area but not nest. Species not observed.
Yellow rail <i>Coturnicops noveboracensis</i>	SSC	Requires sedge marshes/meadows with moist soil or shallow standing water.	No Potential. No suitable habitat present. No occurrences documented in the CNDDDB within 1.0 mi of the Project Area. Species not observed.
California black rail <i>Laterallus jamaicensis coturniculus</i>	ST, FP	Yearlong resident of saline, brackish and fresh emergent wetlands.	No Potential. No suitable habitat present. One known occurrence documented in the CNDDDB within 1.0 mi of the Project Area. Species not observed.
California Ridgway's rail <i>Rallius obsoletus obsoletus</i>	FE, SE, FP	Yearlong resident of saline, brackish and fresh emergent wetlands.	No Potential. No suitable habitat present. No known occurrence documented in the CNDDDB within 1.0 mi of the Project Area. Species not observed.
Western snowy plover <i>Charadris alexandrinus nivosus</i>	FT, SSC	Common on sandy marine and estuarine shores.	No Potential. No suitable habitat present. No known occurrence documented in the CNDDDB within 1.0 mi of the Project Area. Species not observed.

NAME	STATUS ¹	HABITAT	POTENTIAL FOR OCCURRENCE IN PROJECT AREA ²
California least tern <i>Sternula antillarum browni</i>	FE, SE	In San Francisco Bay breeding colonies are located in abandoned salt ponds and along estuarine shores. Nests on barren to sparsely vegetated sites near water and in areas relatively free of human or predatory disturbances.	No Potential. No suitable habitat present. No known occurrence documented in the CNDDDB within 1.0 mi of the Project Area. Species not observed.
Western burrowing owl <i>Athene cunicularia</i>	SSC	Occurs in open, treeless areas with low, sparse vegetation. Typically found in grassland, desert, and steppe habitats; may also utilize agriculture fields, pastures, and fairly urbanized vacant or adjacent lots. Often associated with high densities of burrowing mammals.	Low. Minimal suitable habitat present. One known occurrence documented in the CNDDDB within 1.0 mi of the Project Area. No burrows or suitable nesting habitat were observed. The trees and vineyard in the Project Area don't provide treeless grasslands typically inhabited by this species. Furthermore, burrowing owls are prey for various hawks that are known to be present on and adjacent to the Project Area. Species not observed.
Northern spotted owl <i>Strix occidentalis caurina</i>	FT, ST	Breeds and roosts in forest with large old trees, snags, dense canopies, multiple canopy layers, and downed woody debris.	No Potential. No suitable habitat present. No known occurrence documented in the CNDDDB within 1.0 mi of the Project Area. Species not observed.
Black swift <i>Cypseloides niger</i>	SSC	Constructs nests in moist locations on sea cliffs above surf or on cliffs behind, or adjacent to waterfalls in deep canyons.	No Potential. No suitable habitat present. No known occurrence documented in the CNDDDB within 1.0 mi of the Project Area. Species not observed.
Bank swallow <i>Riparia riparia</i>	ST	Neotropical migrant found primarily in riparian and other lowland habitats. Nests in holes dug in cliffs and river banks made of fine-textured or sandy soils near streams, rivers, ponds, lakes, and oceans.	No Potential. No suitable habitat present. No known occurrence documented in the CNDDDB within 1.0 mi of the Project Area. Species not observed.
Suisun song sparrow <i>Melospiza melodia maxillaris</i>	SSC	Year-round range is confined to tidal salt and brackish marshes fringing the Carquinez strait and Suisun bay east to Antioch, at the confluence of the San Joaquin and Sacramento rivers.	No Potential. No suitable habitat present. No known occurrence documented in the CNDDDB within 1.0 mi of the Project Area. Species not observed.
San Pablo song sparrow <i>Melospiza melodia samuelis</i>	SSC	Year-round range is confined to tidal and muted tidal salt marshes fringing San Pablo Bay.	No Potential. No suitable habitat present. No known occurrence documented in the CNDDDB within 1.0 mi of the Project Area. Species not observed.

NAME	STATUS ¹	HABITAT	POTENTIAL FOR OCCURRENCE IN PROJECT AREA ²
Tricolored blackbird <i>Agelaius tricolor</i>	SCE, SSC	Breeds near fresh water, preferably in emergent wetlands with tall, dense cattails or tules, also in thickets of willow, blackberry, wild rose, tall herbs. Forages in grassland and cropland habitats.	No Potential. No suitable habitat present. One known occurrence documented in the CNDDDB within 1.0 mi of the Project Area. Species not observed.
Yellow-headed blackbird <i>Xanthocephalus xanthocephalus</i>	SSC	Nests in fresh emergent wetland with dense vegetation and deep water.	No Potential. No suitable habitat present. No known occurrence documented in the CNDDDB within 1.0 mi of the Project Area. Species not observed.
Saltmarsh common yellowthroat <i>Geothlypis trichas sinuosa</i>	SSC	Breeds and winters in wet meadow and fresh and saline emergent wetland habitats.	No Potential. No suitable habitat present. No known occurrence documented in the CNDDDB within 1.0 mi of the Project Area. Species not observed.
Mammals			
Salt-marsh harvest mouse <i>Reithrodontomys raviventris</i>	FE, SE, FP	Found only in saline emergent wetlands of San Francisco Bay and its tributaries.	No Potential. No suitable habitat present. One known occurrence documented in the CNDDDB within 1.0 mi of the Project Area. Species not observed.
American badger <i>Taxidea taxus</i>	SSC	Found throughout California, but most common in drier open stages of most shrub forest and herbaceous habitats with friable soil.	Low. Minimal suitable habitat present. No known occurrences documented in the CNDDDB within 1.0 mi of the Project Area. The Project Area and much of the surrounding parcels are highly disturbed agricultural land that is regularly disked or disturbed, and do not provide suitable habitat. Species not observed.

Notes:

¹ **Status**

- FE – Federally listed as Endangered
- FT – Federally listed as Threatened
- FP – California Department of Fish and Wildlife Fully Protected
- SE – State of California listed as Endangered
- ST – State of California listed as Threatened
- SCE – State of California candidate for listing as Endangered
- SCT – State of California candidate for listing as Threatened
- SSC – California Department of Fish and Wildlife Species of Special Concern

² **Definitions Regarding Potential for Occurrence**

- No potential – Habitat on and adjacent to the Project Area is unsuitable for the species requirements (foraging, breeding, cover, substrate, elevation, hydrology, plant community, site history, and disturbance regime).
- Low – Few of the habitat components meeting the species requirements are present, and/or the majority of habitat on and adjacent to the site is unsuitable or of poor quality. The species is not likely to be found on the site.

- Moderate – Some of the habitat components meeting the species requirements are present, and/or only some of the habitat on or adjacent to the site is unsuitable. The species has a moderate probability of being found on the site.
- High – All of the habitat components meeting the species requirements are present, and/or most of the habitat on or adjacent to the site is highly suitable. The species has a high probability of being found on the site.
- Present – Species is observed on the site or has been recorded (i.e., CNDDDB, or other reports) on the site recently.

Table 2. Special-status Plants Identified from Background Research

NAME Bloom period	STATUS¹	HABITAT	POTENTIAL FOR OCCURRENCE IN PROJECT AREA²
Napa false indigo <i>Amorpha californica</i> var. <i>napensis</i> April – June	1B.2	Broadleaved upland forest, chaparral, cismontane woodland. Openings in forest or woodland or in chaparral. 390-6,560 ft.	Low. Known from region. Wooded habitat along Suscol Creek is marginally suitable for this species. Project Area likely too low in elevation. Not observed during survey.
Alkali milk-vetch <i>Astragalus tener</i> var. <i>tener</i> March – June	1B.2	Alkali playa, valley and foothill grassland, vernal pools. Low ground, alkali flats, and flooded lands; in annual grassland or in playas or vernal pools. 0-195 ft.	None. A single CNDDDB occurrence is known within 1.0 mi of Project Area. Preferred conditions not represented in Project Area. Not observed during survey.
Big tarplant <i>Blepharizonia plumosa</i> July – October	1B.1	Valley and foothill grassland. Dry hills and plains in annual grassland. Clay to clay loam soils; usually on slopes and often in burned areas. 95-1,655 ft.	Low. Suitable annual grassland habitat is found in Project Area. Unlikely to occur. Not observed during survey.
Soft salty bird's-beak <i>Chloropyron molle</i> ssp. <i>molle</i> June – November	FE, CR, 1B.2	Coastal salt marsh. In coastal salt marsh associated with <i>Distichlis</i> , <i>Salicornia</i> , <i>Frankenia</i> , etc. 0-10 ft.	None. Project Area lacks suitable salt marsh habitat occupied by this taxon. Not observed during survey.
Western leatherwood <i>Dirca occidentalis</i> January – March (April)	1B.2	Broadleaved upland forest, chaparral, closed cone coniferous forest, cismontane woodland, north coast coniferous forest, riparian forest, riparian woodland. On brushy slopes, mesic sites; mostly in mixed evergreen and foothill woodland communities. 80-1,395 ft.	Low. Known from region. Wooded habitat along Suscol Creek is marginally suitable for this species. Not observed during survey.
Dwarf downingia <i>Downingia pusilla</i> March – May	2B.2	Vernal lake and pool margins with a variety of associates. In several types of vernal pools. Valley and foothill grassland (mesic). 0-1,460 ft.	None. Two CNDDDB occurrences known within 1.0 mi of Project Area. Preferred mesic or vernal pool habitat not found in Project Area. Not observed during survey.
Jepson's coyote-thistle <i>Eryngium jepsonii</i> April – August	1B.2	Vernal pools, valley and foothill grassland. Clay. 5-985 ft.	Low. Known from region. Marginally suitable conditions found within Project Area. Not observed during survey.
Congested-headed hayfield tarplant <i>Hemizonia congesta</i> ssp. <i>congesta</i> April – November	1B.2	Preference for valley and foothill grasslands. Sometimes along roadsides. 66 – 1,837 ft.	Low. Known from region. Suitable grassland habitat with limited disturbance not present within Project Area. Not observed during survey.

NAME Bloom period	STATUS ¹	HABITAT	POTENTIAL FOR OCCURRENCE IN PROJECT AREA ²
Santa Cruz Tarplant <i>Holocarpha macradenia</i> June – October	FT, SE, 1B.1	Generally clay or sandy substrates in coastal prairie, coastal scrub, or valley and foothill grassland. 33-722 ft.	None. Project Area outside distribution of taxon in disturbed agricultural setting. Conditions unsuitable. Not observed during survey.
Contra Costa goldfields <i>Lasthenia conjugens</i> March – June	FE, 1B.1	Valley and foothill grassland, vernal pools, alkaline playas, cismontane woodland, low depressions, in open grassy areas. 0-1,540 ft.	None. Known from one occurrence within 1.0 mi of Project Area (CDFW 2019). Preferred conditions not present within Project Area. Disturbed annual grassland surrounding Project Area is unlikely to support this species. Not observed during survey.
Delta tule pea <i>Lathyrus jepsonii</i> var. <i>jepsonii</i> May – September July (July-September)	1B.2	Marshes and swamps. In freshwater and brackish marshes. Usually on marsh and slough edges. 0-15 ft.	None. Known from two occurrences within 1.0 mi of Project Area (CDFW 2019). Suitable habitat not present within project area. Not observed during survey.
Legenere <i>Legenere limosa</i> April – June	1B.1	Vernal pools. In beds of vernal pools. 0-2,885 ft.	None. A single occurrence is found within 1.0 mi of Project Area. Preferred conditions not represented in Project Area. Not observed during survey.
Woolly-headed lessingia <i>Lessingia hololeuca</i> June – October	3, LR	Coastal scrub, lower montane coniferous forest, valley and foothill grassland, broadleaved upland forest. Clay, serpentine; roadsides, fields. 45-1,000 ft.	Low. Known from region. Marginally suitable conditions found within Project Area. No congeners seen. Not observed during survey.
Mason's lilaepsis <i>Lilaeopsis masonii</i> April – November	SR, 1B.1	Marshes and swamps, riparian scrub. Tidal zones, in muddy or silty soil formed through river deposition or river bank erosion. In brackish or freshwater. 0-35 ft.	None. A single occurrence is found within 1.0 mi of Project Area. Preferred conditions not represented in Project Area. Not observed during survey.
Napa bluecurls <i>Trichostema ruygtii</i> June – October	1B.2	Cismontane woodland, chaparral, valley and foothill grassland, vernal pools, lower montane coniferous forest. Often in open, sunny areas. Has been found in vernal pools. 95-2,230 ft.	Low. Known from region. Marginally suitable conditions found within Project Area. Not observed during survey.
Two-fork clover <i>Trifolium amoenum</i> April – June	FE, 1B.1	Valley and foothill grassland, coastal bluff scrub. Sometimes on serpentine soil, open sunny sites, swales. Most recently cited on roadside and eroding cliff face. 15-1,360 ft.	Low. Known from region. Marginally suitable conditions found within Project Area. Not observed during survey.

NAME Bloom period	STATUS ¹	HABITAT	POTENTIAL FOR OCCURRENCE IN PROJECT AREA ²
Saline clover <i>Trifolium hydrophilum</i> April – June	1B.2	Marshes and swamps, valley and foothill grassland, vernal pools. Mesic, alkaline sites. 0-985 ft.	None. Two CNDDDB occurrences are within 1.0 mi of the Project Area. Suitable habitat is absent from Project Area. Not observed during surveys.

Notes:

¹Status

FE	=	Federally listed endangered
FT	=	Federally listed threatened
SE	=	State listed endangered
CR	=	California State rare
LR	=	Napa County Locally Rare Taxa

CRPR Listing (CNPS 2019)

List 1B	=	Plants rare, threatened, or endangered in California and elsewhere.
List 2	=	Plants rare, threatened, or endangered in California but more common elsewhere.

Extensions

.1	Seriously endangered in California.
.2	Fairly endangered in California.
.3	Not very endangered in California.

² Definitions Regarding Potential for Occurrence

- No potential – Habitat on and adjacent to the Project Area is unsuitable for the species requirements (foraging, breeding, cover, substrate, elevation, hydrology, plant community, site history, and disturbance regime).
- Low – Few of the habitat components meeting the species requirements are present, and/or the majority of habitat on and adjacent to the site is unsuitable or of poor quality. The species is not likely to found on the site.
- Moderate – Some of the habitat components meeting the species requirements are present, and/or only some of the habitat on or adjacent to the site is unsuitable. The species has a moderate probability of being found on the site.
- High – All of the habitat components meeting the species requirements are present, and/or most of the habitat on or adjacent to the site is highly suitable. The species has a high probability of being found on the site.
- Present – Species is observed on the site or has been recorded (i.e., CNDDDB, or other reports) on the site recently.

Appendix B

Wildlife Species Observed in the Project Area

Scientific Name	Common Name
Birds	
<i>Buteo jamaicensis</i>	red-tailed hawk
<i>Buteo lineatus</i>	red-shouldered hawk
<i>Buteo swainsoni</i>	Swainson's hawk
<i>Cathartes aura</i>	turkey vulture
<i>Circus hudsonius</i>	northern harrier
<i>Corvis corax</i>	common raven
<i>Elanus leucurus</i>	white-tailed kite
<i>Melanerpes formicivorus</i>	acorn woodpecker
<i>Melospiza crissalis</i>	California towhee
<i>Mimus polyglottos</i>	northern mockingbird
<i>Sayornis nigricans</i>	black-headed phoebe
<i>Setophaga coronata</i>	yellow-rumped warbler
<i>Sturnus vulgaris</i>	European starling
<i>Tachycineta bicolor</i>	tree swallow
<i>Tyto alba</i>	barn owl
<i>Turdus migratorius</i>	American Robin
<i>Zenaidura macroura</i>	mourning dove
Mammals	
<i>Canis latrans</i>	coyote (scat)
<i>Odocoileus hemionus columbianus</i>	black-tailed deer (tracks)
<i>Otospermophilus beecheyi</i>	California ground squirrel

Appendix C

Plant Species Observed in the Project Area

Scientific Name	Common Name
Gymnosperms - Coniferophyta	
<i>Pinus pinea</i> *	Italian stone pine
<i>Pinus radiata</i>	Monterey pine
<i>Sequoia sempervirens</i>	coast redwood
Angiosperms - Dicots	
<i>Acacia melanoxylon</i> *	blackwood acacia
<i>Aesculus californica</i>	California buckeye
<i>Amaranthus albus</i> *	pigweed amaranth
<i>Aristolochia californica</i>	California pipevine
<i>Artemisia douglasiana</i>	California mugwort
<i>Baccharis pilularis</i>	coyote brush
<i>Calendula arvensis</i> *	field marigold
<i>Callitriche heterophylla</i>	water starwort
<i>Carduus pycnocephalus</i> *	Italian thistle
<i>Cichorium intybus</i> *	chicory
<i>Conium maculatum</i> *	poison hemlock
<i>Convolvulus arvensis</i> *	bindweed
<i>Croton setiger</i>	turkey mullein
<i>Echinopsis (terscheckii)</i> *	cardon grande cactus
<i>Erigeron canadensis</i>	Canada horseweed
<i>Erodium cicutarium</i> *	red stemmed filaree
<i>Eschscholzia californica</i>	California poppy
<i>Eucalyptus camaldulensis</i> *	red gum
<i>Eucalyptus globulus</i> *	blue gum
<i>Ficus carica</i> *	common fig
<i>Helminthotheca echioides</i> *	bristly ox-tongue
<i>Hirschfeldia incana</i> *	wild mustard
<i>Kickxia elatine</i> *	sharp leaved fluellin
<i>Lactuca serriola</i> *	prickly lettuce
<i>Lysimachia arvensis</i>	scarlet pimpernel
<i>Malus pumila</i> *	domestic apple
<i>Malva neglecta</i> *	common mallow
<i>Medicago polymorpha</i> *	bur clover
<i>Nerium oleander</i> *	oleander
<i>Persicaria punctata</i>	dotted smartweed
<i>Populus fremontii</i>	Fremont cottonwood
<i>Prunus (avium – cerasus)</i> *	domestic cherry
<i>Prunus (domestica – salicina – simonii)</i> *	domestic plum
<i>Quercus agrifolia</i>	coast live oak
<i>Quercus lobata</i>	valley oak
<i>Raphanus sativus</i> *	cultivated radish
<i>Robinia pseudoacacia</i> *	black locust
<i>Rosa sp. (cultivar)</i> *	cultivated rose
<i>Rubus armeniacus</i> *	Himalayan blackberry
<i>Rumex crispus</i>	curly dock
<i>Salix lasiandra</i>	Pacific willow
<i>Salvia apiana</i>	white sage
<i>Sambucus nigra</i>	black elderberry
<i>Silybum marianum</i> *	milk thistle
<i>Sonchus asper</i> *	spiny sow thistle
<i>Symphoricarpos albus</i>	common snowberry
<i>Taraxacum officinale</i> *	dandelion

Scientific Name	Common Name
<i>Tragopogon porrifolius</i> *	purple salsify
<i>Tropaeolum majus</i> *	garden nasturtium
<i>Umbellularia californica</i>	California bay laurel
<i>Urtica dioica</i>	stinging nettle
<i>Vicia villosa</i> *	hairy vetch
<i>Vitis vinifera</i> *	wine grape
Angiosperms - Monocots	
<i>Alisma lanceolatum</i> *	lanceleaf water plantain
<i>Avena barbata</i> *	slim oat
<i>Bromus diandrus</i> *	ripgut brome
<i>Bromus hordeaceus</i> *	soft brome
<i>Bromus madritensis</i> *	foxtail brome
<i>Cyperus eragrostis</i>	tall Cyperus
<i>Festuca perennis</i> *	Italian rye grass
<i>Hordeum marinum</i> *	seaside barley
<i>Hordeum vulgare</i> *	common barley
<i>Phleum pratense</i> *	Timothy grass
* = non-native taxa	
() = putative crop wild relatives involved in historical breeding events	

Appendix D

Vegetation Features in Biological Resource Evaluation Area

Vegetation Type² MCV1 (Sawyer et al. 1995)	Acres within Project Area	Acres within 1 mile of Project Area	Acres within BREA
(Bulrush - Cattail) Fresh Water Marsh NFD ⁴ Super Alliance	None	None	98
(<i>Carex</i> spp. - <i>Juncus</i> spp - Wet Meadow Grasses) NFD Super Alliance	None	1	96
Agriculture	19	668	53,475
Black Oak Alliance	None	None	720
Blue Oak Alliance	None	None	3173
Brewer Willow Alliance	None	None	83
California Annual Grasslands Alliance	None	718	19,804
California Bay - Leather Oak - (<i>Rhamnus</i> spp.) Mesic Serpentine NFD Super Alliance	None	None	1,161
California Bay - Madrone - Coast Live Oak - (Black Oak Big - Leaf Maple) NFD Super Alliance	None	None	15,798
California Coast Live Oak Alliance	None	None	50
Canyon Live Oak Alliance	None	None	275
Chamise - Wedgeleaf Ceanothus Alliance	None	None	159
Chamise Alliance	None	None	12,048
Coast Live Oak - Blue Oak - (Foothill Pine) NFD Association	None	None	11,746
Coast Live Oak Alliance	None	48	11,261
Coast Redwood - Douglas-fir / California Bay NFD Association	None	None	2,790
Coast Redwood Alliance	None	None	291
Coyote Brush - California Sagebrush - (Lupine spp.) NFD Super Alliance	None	None	42
Douglas-fir - Ponderosa Pine Alliance	None	None	4,168
Douglas-fir Alliance	None	None	15,557
Eucalyptus Alliance	4	13	361
Foothill Pine / Mesic Non-serpentine Chaparral NFD Association	None	None	132

² From WICC of Napa County 2005 and M. Lamborn, GIS Department Coordinator, pers. comm., March 2018 using Sawyer et al. 1995).

⁴ NFD- not formally defined.

Vegetation Type² MCV1 (Sawyer et al. 1995)	Acres within Project Area	Acres within 1 mile of Project Area	Acres within BREA
Foothill Pine Alliance	None	None	619
Interior Live Oak - Blue Oak - (Foothill Pine) NFD Association	None	None	353
Interior Live Oak Alliance	None	None	19
Knobcone Pine Alliance	None	None	3,312
Lacustrine	None	None	3
Leather Oak - California Bay - <i>Rhamnus</i> spp. Mesic Serpentine NFD Alliance	None	None	651
Leather Oak - White Leaf Manzanita - Chamise Xeric Serpentine NFD Super Alliance	None	None	1,778
Mixed Manzanita - (Interior Live Oak -California Bay - Chamise) West County NFD Alliance	None	None	5,997
Mixed Oak Alliance	None	2	15,923
Mixed Willow Super Alliance	None	None	274
Oregon White Oak Alliance	None	None	1,122
Ponderosa Pine Alliance	None	None	91
Riverine, Lacustrine, and Tidal Mudflats	None	None	6
Rock Outcrop	None	None	1,001
Saltgrass - Pickleweed NFD Super Alliance	None	95	1,446
Sargent Cypress Alliance	None	None	2
Sclerophyllous Shrubland Formation	None	None	3,006
Scrub Interior Live Oak - Scrub Oak - (California Bay - Flowering Ash - Birch Leaf Mountain Mahogany - Toyon - California Buckeye) Mesic East County NFD Super Alliance	None	None	1,553
Serpentine Barren	None	None	1
Serpentine Grasslands NFD Super Alliance	None	None	228
Tanbark Oak Alliance	None	None	54
Urban or Built-up	None	320	23,324
Unknown	None	0	505
Upland Annual Grasslands and Forbs Formation	2	431	5,855

Vegetation Type² MCV1 (Sawyer et al. 1995)	Acres within Project Area	Acres within 1 mile of Project Area	Acres within BREA
Vacant	None	None	1,443
Valley Oak - (California Bay - Coast Live Oak - Walnut - Ash) Riparian Forest NFD Association	None	None	3,164
Valley Oak - Fremont Cottonwood - (Coast Live Oak) Riparian Forest NFD Association	1	23	407
Valley Oak Alliance	None	2	901
Water	None	282	5,826
White Alder (Mixed Willow - California Bay - Big Leaf Maple) Riparian Forest NFD Association	None	None	729
White Leaf Manzanita - Leather Oak - (Chamise - <i>Ceanothus</i> spp.) Xeric Serpentine NFD Super Alliance	None	None	953
Winter-Rain Sclerophyll Forests and Woodlands Formation	None	None	618
Bigleaf Maple Forest	None	None	6
Mapped within the Project Area.			

-  Napa River Watershed
-  Soscol Ferry Solar Project Area
-  One-mile Buffer
-  Project Area
-  Stream
-  National Wetland Inventory (NWI) Wetland
- Manual of California Vegetation (MCV)
 -  (Bulrush - Cattail) Fresh Water Marsh NFD Super Alliance
 -  (Carex spp. - Juncus spp - Wet Meadow Grasses) NFD Super Alliance
 -  Agriculture
 -  Black Oak Alliance
 -  Blue Oak Alliance
 -  Brewer Willow Alliance
 -  California Annual Grasslands Alliance
 -  California Bay - Leather Oak - (Rhamnus spp.) Mesic Serpentine NFD Super Alliance
 -  California Bay - Madrone - Coast Live Oak - (Black Oak Big - Leaf Maple) NFD Super Alliance
 -  California coast live oak Alliance
 -  Canyon Live Oak Alliance
 -  Chamise - Wedgeleaf Ceanothus Alliance
 -  Chamise Alliance
 -  Coast Live Oak - Blue Oak - (Foothill Pine) NFD Association
 -  Coast Live Oak Alliance
 -  Coast Redwood - Douglas-fir / California Bay NFD Association
-  Coast Redwood Alliance
-  Coyote Brush - California Sagebrush - (Lupine spp.) NFD Super Alliance
-  Douglas-fir - Ponderosa Pine Alliance
-  Douglas-fir Alliance
-  Eucalyptus Alliance
-  Foothill Pine / Mesic Non-serpentine Chaparral NFD Association
-  Foothill Pine Alliance
-  Interior Live Oak - Blue Oak - (Foothill Pine) NFD Association
-  Interior Live Oak Alliance
-  Knobcone Pine Alliance
-  Lacustrine
-  Leather Oak - California Bay - Rhamnus spp. Mesic Serpentine NFD Alliance
-  Leather Oak - White Leaf Manzanita - Chamise Xeric Serpentine NFD Super Alliance
-  Mixed Manzanita - (Interior Live Oak -California Bay - Chamise) West County NFD Alliance
-  Mixed Oak Alliance
-  Mixed Willow Super Alliance
-  Oregon White Oak Alliance
-  Ponderosa Pine Alliance
-  Riverine, Lacustrine and Tidal Mudflats
-  Rock Outcrop
-  Saltgrass - Pickleweed NFD Super Alliance
-  Sargent Cypress Alliance
-  Sclerophyllous Shrubland Formation
-  Scrub Interior Live Oak - Scrub Oak - (California Bay - Flowering Ash - Birch Leaf Mountain Mahogany - Toyon - California Buckeye) Mesic East County NFD Super Alliance
-  Serpentine Barren
-  Serpentine Grasslands NFD Super Alliance
-  Tanbark Oak Alliance
-  Unknown
-  Upland Annual Grasslands & Forbs Formation
-  Urban or Built-up
-  Vacant
-  Valley Oak - (California Bay - Coast Live Oak - Walnut - Ash) Riparian Forest NFD Association
-  Valley Oak - Fremont Cottonwood - (Coast Live Oak) Riparian Forest NFD Association
-  Valley Oak Alliance
-  Water
-  White Alder (Mixed Willow - California Bay - Big Leaf Maple) Riparian Forest NFD Association
-  White Leaf Manzanita - Leather Oak - (Chamise - Ceanothus spp.) Xeric Serpentine NFD Super Alliance
-  Winter-Rain Sclerophyll Forests & Woodlands Formation

Created by: C.BARKER/WITZLER Document Path: Z:\GIS\Graphics\GIS Projects\2019\Projects\1481 - 07 Soscol_Ferry\BREA_Veg_Type_BREA_LEGEND.mxd



Source: Napa Vegetation, The Information Center for the Environment, UC Davis (August, 2019); National Wetland Inventory (NWI); Streams, Napa County Resource Conservation District; CALVEG (August, 2019); DeLorme Street Map, Ganda GIS 2019

Legend Appendix D.
Vegetation Types Within the BREA
 Soscol Ferry Solar Project
 Napa County, California
 August 2019



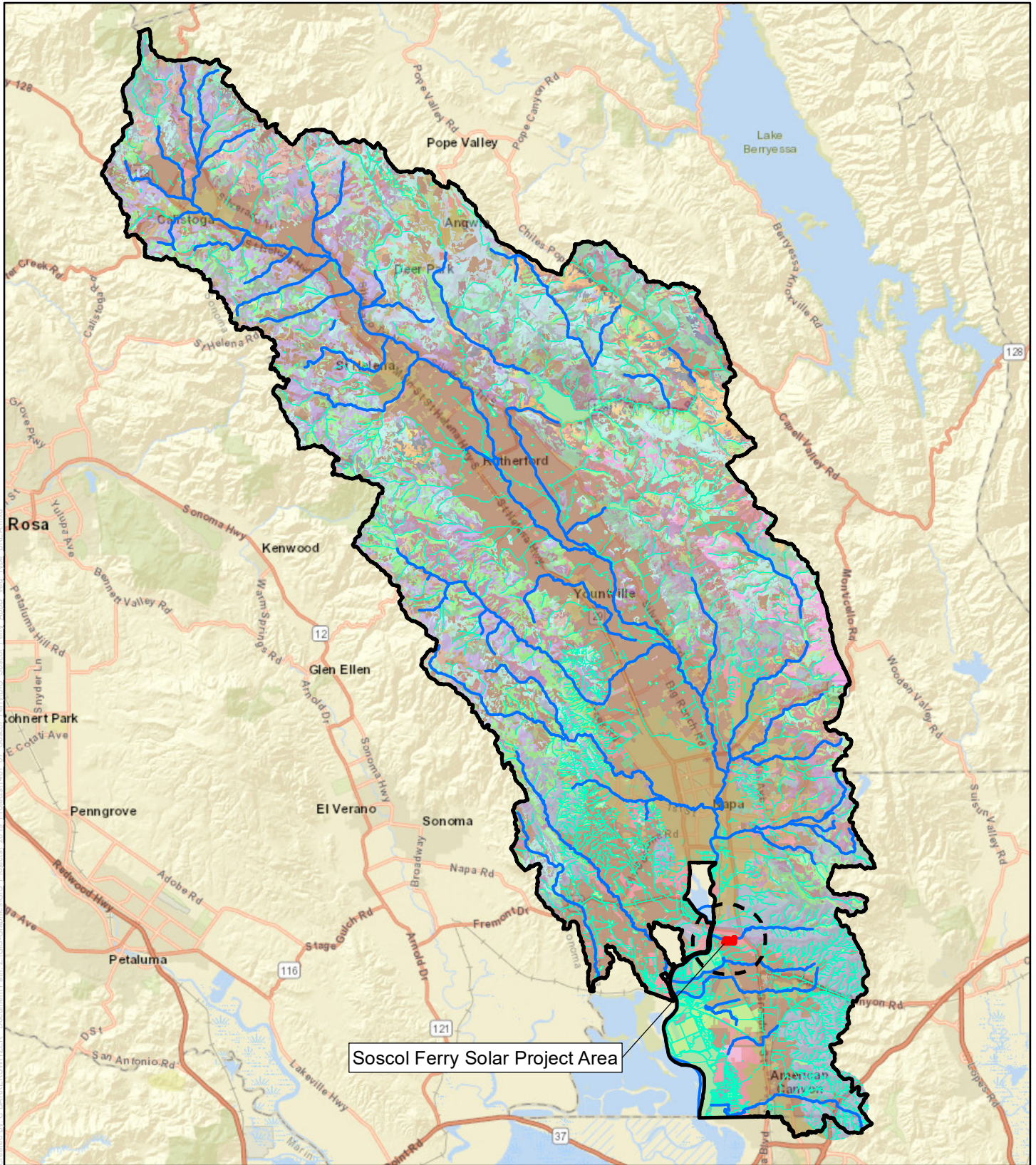

Created by: C. BARBER/WITZBERG Document Path: Z:\GIS-Graphics\GIS Projects_2019\Projects\1481_07_Soscol_Ferry_Armd_Med_Type_BRE_Armd



Source: Napa Vegetation, The Information Center for the Environment, UC Davis (August, 2019); National Wetland Inventory (NWI); Streams, Napa County Resource Conservation District; CALVEG (August, 2019); DeLorme Street Map, Ganda GIS 2019

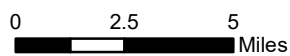

Appendix D. Vegetation Types Within the BRE

Soscol Ferry Solar Project
 Napa County, California
 August 2019



Appendix E

Representative Photos of the Project Area



Photo 1: Facing southwest. Western margin of Project Area and prominent row of *Eucalyptus* spp. and assorted plantings (July 17, 2019).



Photo 2: Facing southeast. Upland Annual Grasslands and Forbs Formation south of Project Area (July 17, 2019).



Photo 3: Facing southeast. Upland Annual Grasslands and Forbs Formation to east of Project Area (July 17, 2019).



Photo 4: Facing southwest. Northern boundary of Project Area. California buckeye, black locust, and valley oak (July 17, 2019).



Photo 5: Facing west. Median strip of black locust (two coast live oaks). Tiered topography – northern vineyard situated lower than southern unit of parcel. Aquatic or wetland features not found within elevated row/berm (July 17, 2019).



Photo 6: Facing west. Rows of grape (*Vitis vinifera*) occupying a majority of the Project Area (July 17, 2019).



Photo 7: Facing east. Dry bed of Suscol Creek. Wetland (dotted smartweed - OBL) and riparian (Pacific willow - FACW) vegetation shown (Lichvar et al. 2016) (July 17, 2019).



Photo 8: Facing northwest. Northern boundary of Project Area. Valley Oak – Fremont Cottonwood – (Coast Live Oak) Riparian Forest Association (July 17, 2019).



Photo 9: Facing west. Median strip of black locust dividing parcel horizontally in two. Two native coast live oaks found within the non-native black locust (July 17, 2019).

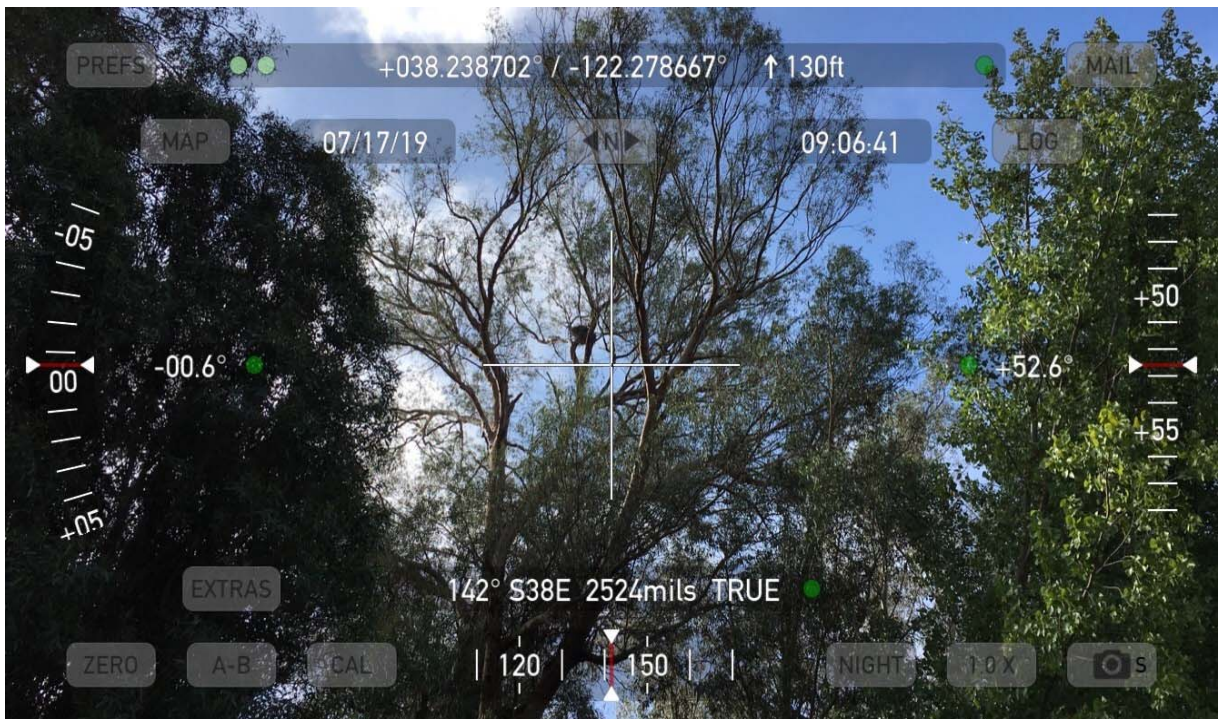

Photo 10: Facing west. Swainson's hawk (*Buteo swainsonii*) nest in eucalyptus tree at the northwest corner of the Project Area (July 17, 2019).



Photo 11: Facing south. Bridge over Suscol Creek connecting access road to parcel (July 17, 2019).



Photo 12: Facing southwest. Portion of seasonal wetland overlapping Project Area along access road. (screenshot August 1, 2019).

Appendix F
Preliminary Layout

PRELIMINARY NOT FOR CONSTRUCTION

SOSCOL FERRY SOLAR C & D

1605, SOSCOL FERRY RD,
NAPA, CA 94559, USA

LAT: 38.237851°
LON: -122.275392°

REV. NO.	DESCRIPTION	DATE
0	FOR UTILITY APPLICATION	08/10/19

SHEET TITLE:

PRELIMINARY LAYOUT

DRAWING NO.:

PV-100

DRAWN BY:

LR

REVIEWED BY:

DATE:

08/10/19

SCALE:

AS SHOWN

PROJECT NO.:

SYSTEM SPECIFICATIONS			
SOSCOL FERRY ROAD C & D			
	ARRAY C	ARRAY D	TOTAL
SYSTEM SIZE DC	1,489.60 kW	1,489.60 kW	2,979.20 kW
SYSTEM SIZE AC	990.00 kW*	990.00 kW*	1,980.00 kW
DC/AC RATIO	1.50	1.50	1.50
MODULE MANUFACTURER	TRINA SOLAR		
MODULE MODEL	TSM-DE14H(I)		
MODULE RATING	380 W		
TOTAL MODULE QTY	3,920	3,920	7,840
MODULES PER STRING	28		
TOTAL NO. OF STRINGS	140	140	280
INVERTER MODEL	SUNGROW SG125HV		
INVERTER RATING	125 kW		
INVERTER QTY	8	8	16
STEP-UP TRANSFORMER	12kV/600V, 1000kVA		
RACKING	ATI HSAT		
INTER-ROW SPACING	13.3'		
PITCH	19.9°		
GCR	33%		
SITE AREA INSIDE FENCE	15.67 Ac		

* PLANT NAMEPLATE LIMITED TO 990 kW AC AND IS CONFIGURED IN FACTORY BY INVERTER MANUFACTURER.

- GENERAL NOTES**
- REFER TO SINGLE LINE DIAGRAM FOR DETAILS.
 - INSTALLATION TO COMPLY WITH NEC 2014 ARTICLE 690 AND ALL APPLICABLE LOCAL, STATE AND NATIONAL CODES OR REGULATIONS.
 - EQUIPMENT SHALL BE LABELED PER NEC 690 AND UTILITY REGULATIONS.
 - 12' ACCESS ROADS SHALL BE DESIGNED TO ACCOMMODATE ALL CONSTRUCTION, OPERATIONS, MAINTENANCE, AND UTILITY TRAFFIC THROUGHOUT THE SITE.
 - DIMENSIONS TO PROPERTY LINES AND EXISTING FEATURES ARE APPROXIMATE PENDING SURVEY.
 - LANDSCAPING WILL BE COMPLIANT TO THE BIOLOGICAL CONSTRAINTS ANALYSIS FOR LANDSCAPING AND WATER EFFICIENT LANDSCAPE ORDINANCE.
 - ALL TOPOGRAPHY, ELEVATION INFORMATION, DRAINAGE PATTERNS AND COURSES ARE SUBJECT TO THE OUTCOME OF DRAINAGE CALCULATIONS AND STORM WATER DRAINAGE REPORT (NOT YET PERFORMED).
 - A 15.5' ACCESS CORRIDOR WILL BE PROVIDED WHICH WILL CONSIST OF 12' GRAVEL ROAD WITH 3' CLEARANCE BETWEEN ROAD AND FENCE.
 - THE CROSS SECTION OF THE PROPOSED 12 FT WIDE ROAD WILL MATCH THE EXISTING GRADE, WHICH SLOPES TOWARD THE PERIMETER FENCE. ROAD CROSS SECTIONS WILL BE DESIGNED TO DRAIN TOWARDS THE FENCE. FINAL CIVIL DESIGN WILL SPECIFY THE PROPOSED GRADES.

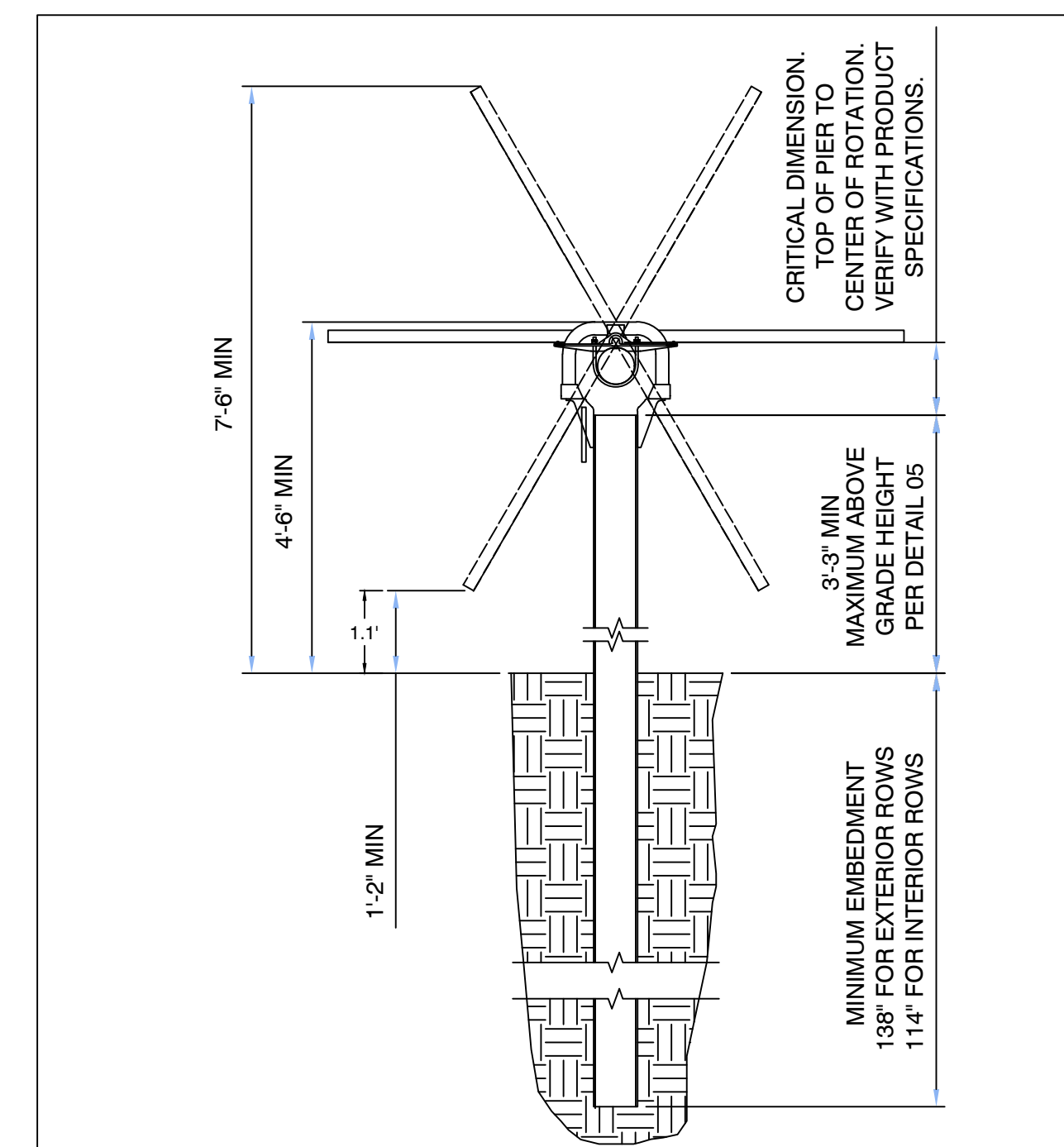

2 RACKING ELEVATION
SCALE: NTS

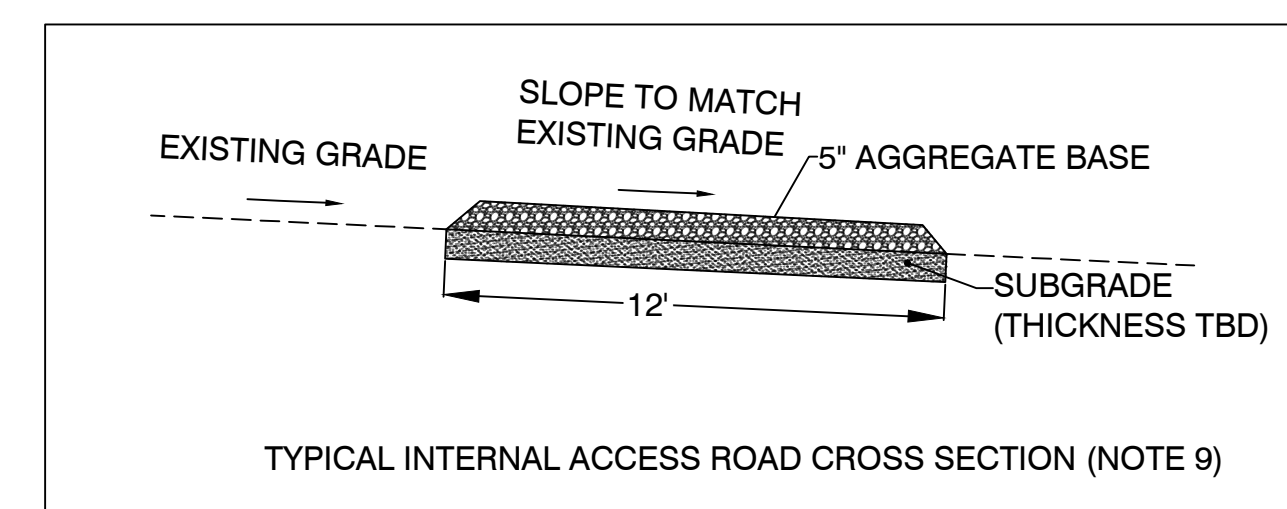

3 ROAD CROSS SECTION
SCALE: NTS

LEGEND

- ATI 84 MODULE TRACKER ROW
- ATI 56 MODULE TRACKER ROW
- ATI 28 MODULE TRACKER ROW
- POWER STATION - (1) MV TRANSFORMER, (1) DAS, (1) WEATHER STATION
- SUNGROW 125kW STRING INVERTER
- 12' WIDE SITE ACCESS GRAVEL ROAD
- (E) WETLAND
- PUBLIC ROAD
- PROPERTY LINE
- PROJECT SITE SECURITY FENCE
- SETBACK
- (E) OH LINES
- MV CABLE
- OAK TREE TO REMAIN
- EXISTING TREES TO BE REMOVED

SYSTEM SPECIFICATIONS

SOSCOL FERRY SOLAR C + D	
SYSTEM SIZE DC	2979.20 kW
SYSTEM SIZE AC	1,980.00 kW
TOTAL ACREAGE	21.34 Ac

PROJECT SETBACKS

SOSCOL FERRY SOLAR C + D	
FRONT	20'
REAR	20'
SIDE	20'
SOSCOL CREEK	150'

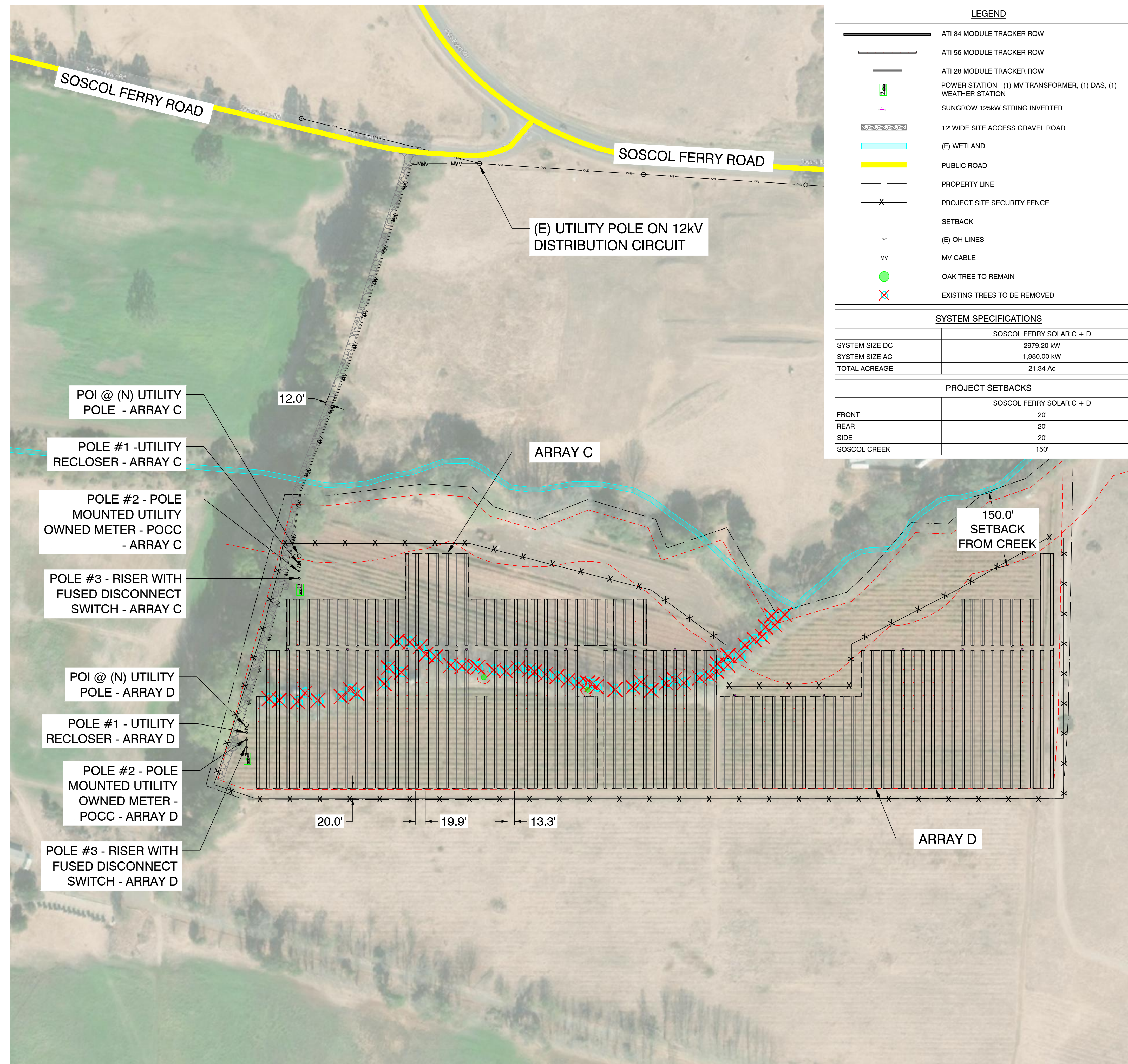

1 ARRAY C & D PLAN
SCALE: 1"=100'



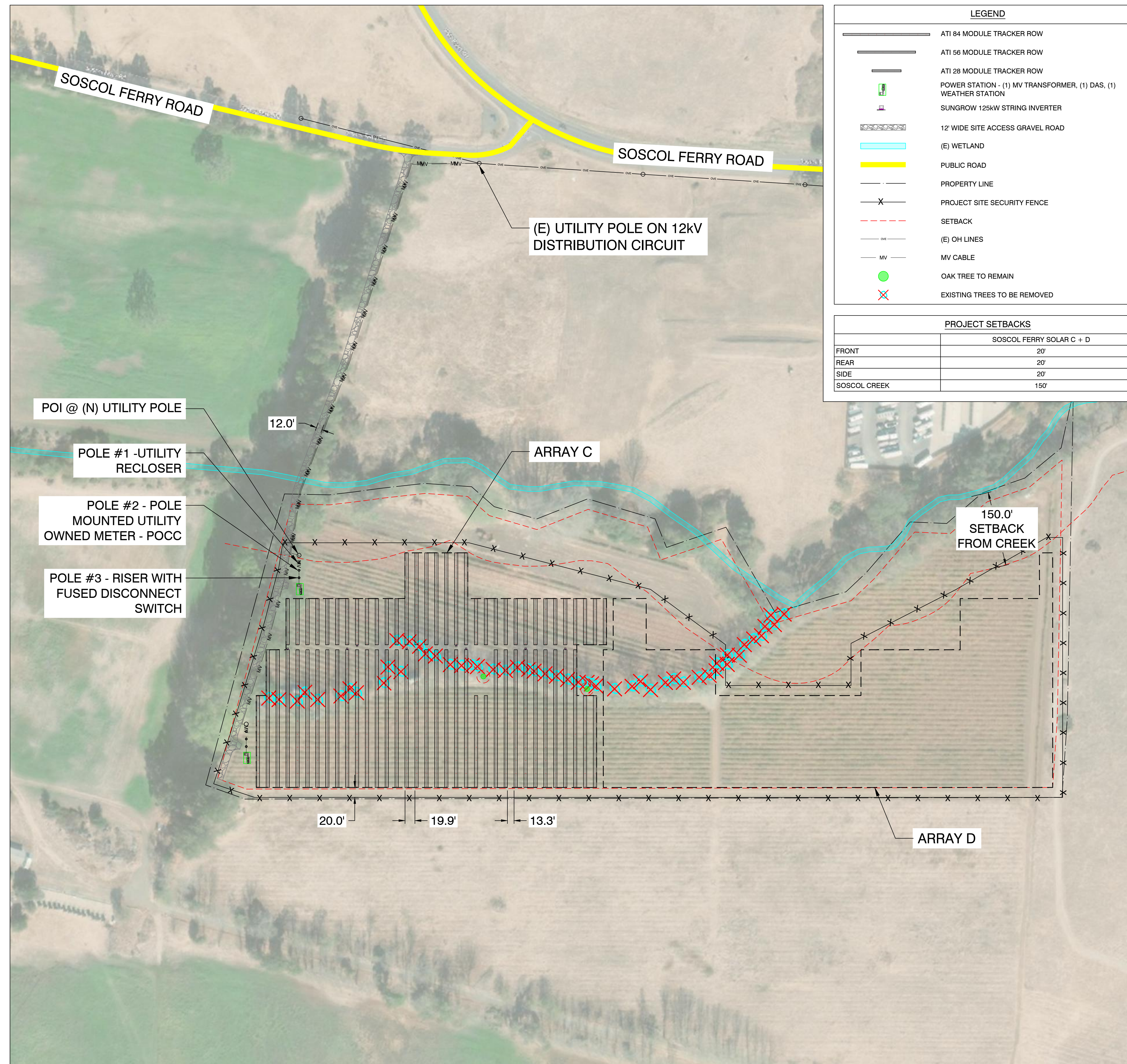

LEGEND	
	ATI 84 MODULE TRACKER ROW
	ATI 56 MODULE TRACKER ROW
	ATI 28 MODULE TRACKER ROW
	POWER STATION - (1) MV TRANSFORMER, (1) DAS, (1) WEATHER STATION
	SUNGROW 125kW STRING INVERTER
	12' WIDE SITE ACCESS GRAVEL ROAD
	(E) WETLAND
	PUBLIC ROAD
	PROPERTY LINE
	PROJECT SITE SECURITY FENCE
	SETBACK
	(E) OH LINES
	MV CABLE
	OAK TREE TO REMAIN
	EXISTING TREES TO BE REMOVED

PROJECT SETBACKS	
	SOSCOL FERRY SOLAR C + D
FRONT	20'
REAR	20'
SIDE	20'
SOSCOL CREEK	150'

SYSTEM SPECIFICATIONS	
SOSCOL FERRY ROAD C	
SYSTEM SIZE DC	1,489.60 kW
SYSTEM SIZE AC	990.00 kW*
DC/AC RATIO	1.50
MODULE MANUFACTURER	TRINA SOLAR
MODULE MODEL	TSM-DE14H(II)
MODULE RATING	380 W
TOTAL MODULE QTY	3,920
MODULES PER STRING	28
TOTAL NO. OF STRINGS	140
INVERTER MODEL	SUNGROW SG125HV
INVERTER RATING	125 kW
INVERTER QTY	8
STEP-UP TRANSFORMER	12kV/600V, 1000kVA
RACKING	ATI HSAT
INTER-ROW SPACING	13.3'
PITCH	19.9'
GCR	33%
SITE AREA INSIDE FENCE	15.67 Ac

- GENERAL NOTES**
- REFER TO SINGLE LINE DIAGRAM FOR DETAILS.
 - INSTALLATION TO COMPLY WITH NEC 2014 ARTICLE 690 AND ALL APPLICABLE LOCAL, STATE AND NATIONAL CODES OR REGULATIONS.
 - EQUIPMENT SHALL BE LABELED PER NEC 690 AND UTILITY REGULATIONS.
 - 12' ACCESS ROADS SHALL BE DESIGNED TO ACCOMMODATE ALL CONSTRUCTION, OPERATIONS, MAINTENANCE, AND UTILITY TRAFFIC THROUGHOUT THE SITE.
 - DIMENSIONS TO PROPERTY LINES AND EXISTING FEATURES ARE APPROXIMATE PENDING SURVEY.
 - LANDSCAPING WILL BE COMPLIANT TO THE BIOLOGICAL CONSTRAINTS ANALYSIS FOR LANDSCAPING AND WATER EFFICIENT LANDSCAPE ORDINANCE.
 - ALL TOPOGRAPHY, ELEVATION INFORMATION, DRAINAGE PATTERNS AND COURSES ARE SUBJECT TO THE OUTCOME OF DRAINAGE CALCULATIONS AND STORM WATER DRAINAGE REPORT (NOT YET PERFORMED).
 - A 15.5' ACCESS CORRIDOR WILL BE PROVIDED WHICH WILL CONSIST OF 12' GRAVEL ROAD WITH 3' CLEARANCE BETWEEN ROAD AND FENCE.
 - THE CROSS SECTION OF THE PROPOSED 12 FT WIDE ROAD WILL MATCH THE EXISTING GRADE, WHICH SLOPES TOWARD THE PERIMETER FENCE. ROAD CROSS SECTIONS WILL BE DESIGNED TO DRAIN TOWARDS THE FENCE. FINAL CIVIL DESIGN WILL SPECIFY THE PROPOSED GRADES.



PRELIMINARY NOT FOR CONSTRUCTION

SOSCOL FERRY SOLAR C

1605, SOSCOL FERRY RD,
NAPA, CA 94559, USA

LAT: 38.237851°
LON: -122.275392°

REV. NO.	DESCRIPTION	DATE
0	FOR UTILITY APPLICATION	08/10/19

SHEET TITLE:

PRELIMINARY LAYOUT

DRAWING NO.:

PV-101

DRAWN BY: LR

REVIEWED BY:

DATE: 08/10/19

SCALE: AS SHOWN

PROJECT NO.:

**PRELIMINARY
NOT FOR
CONSTRUCTION**

**SOSCOL FERRY
SOLAR C**

1605, SOSCOL FERRY RD,
NAPA, CA 94559, USA

LAT: 38.237851°
LON: -122.275392°

REV. NO	DESCRIPTION	DATE
0	FOR UTILITY APPLICATION	08/10/19

SHEET TITLE:

**SINGLE LINE
DIAGRAM**

DRAWING NO.:

E-101

DRAWN BY:

LR

REVIEWED BY:

DATE:

08/10/19

SCALE:

AS SHOWN

PROJECT NO.:

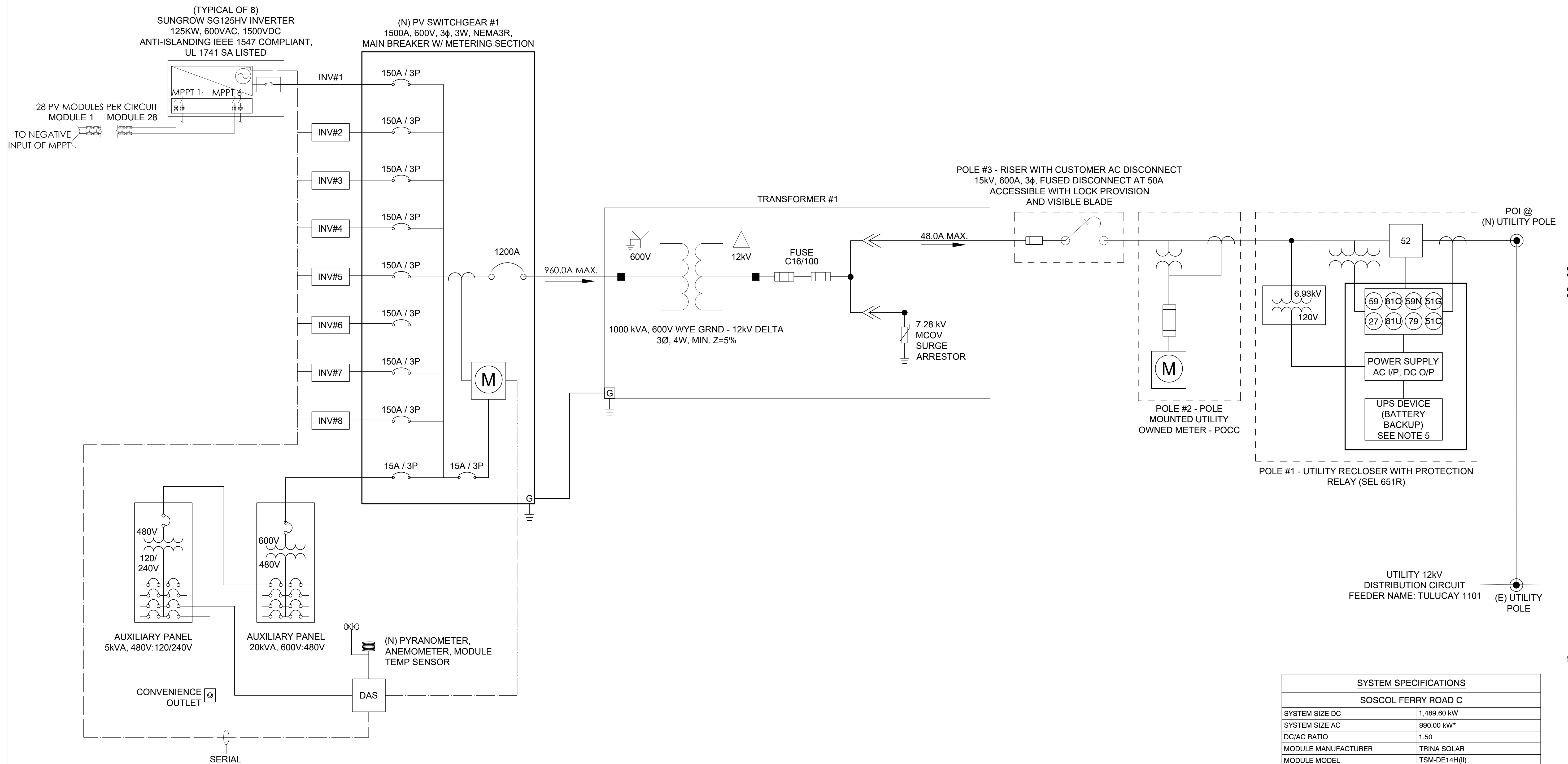

1 SOSCOL FERRY ROAD C SINGLE LINE DIAGRAM

SYSTEM SPECIFICATIONS	
SOSCOL FERRY ROAD C	
SYSTEM SIZE DC	1,489.60 kW
SYSTEM SIZE AC	990.00 kW*
DC/AC RATIO	1.50
MODULE MANUFACTURER	TRINA SOLAR
MODULE MODEL	TSM-DE14H(II)
MODULE RATING	380 kW
TOTAL MODULE QTY	3,920
MODULES PER STRING	28
TOTAL NO. OF STRINGS	140
INVERTER MODEL	SUNGROW SG125HV
INVERTER RATING	125 kW
INVERTER QTY	8
STEP-UP TRANSFORMER	12kV/600V, 1000kVA

* PLANT NAMEPLATE LIMITED TO 990 kW AC AND IS CONFIGURED IN FACTORY BY INVERTER MANUFACTURER.

GENERAL NOTES

- AC MV CIRCUITS SHALL BE INSTALLED AND INTERCONNECTED WITH UTILITY, PER UTILITY SPECIFICATIONS.
- ALL ELECTRICAL WORK SHALL BE IN ACCORDANCE WITH THE 2014 EDITION OF NATIONAL ELECTRIC CODE.
- ALL DC AND AC EQUIPMENT, WHERE APPLICABLE, SHALL BE LISTED AND LABELED PER RECOGNIZED ELECTRICAL TESTING LABORATORY AND INSTALLED PER THE LISTING REQUIREMENTS, THE MANUFACTURER'S INSTRUCTIONS AND IN ACCORDANCE WITH NEC.
- RECLOSER CONTROL SETTINGS TO BE COORDINATED WITH UTILITY AND CONTRACTOR.
- RELAY TO BE PROVIDED WITH 8-HOUR BATTERY BACK-UP.

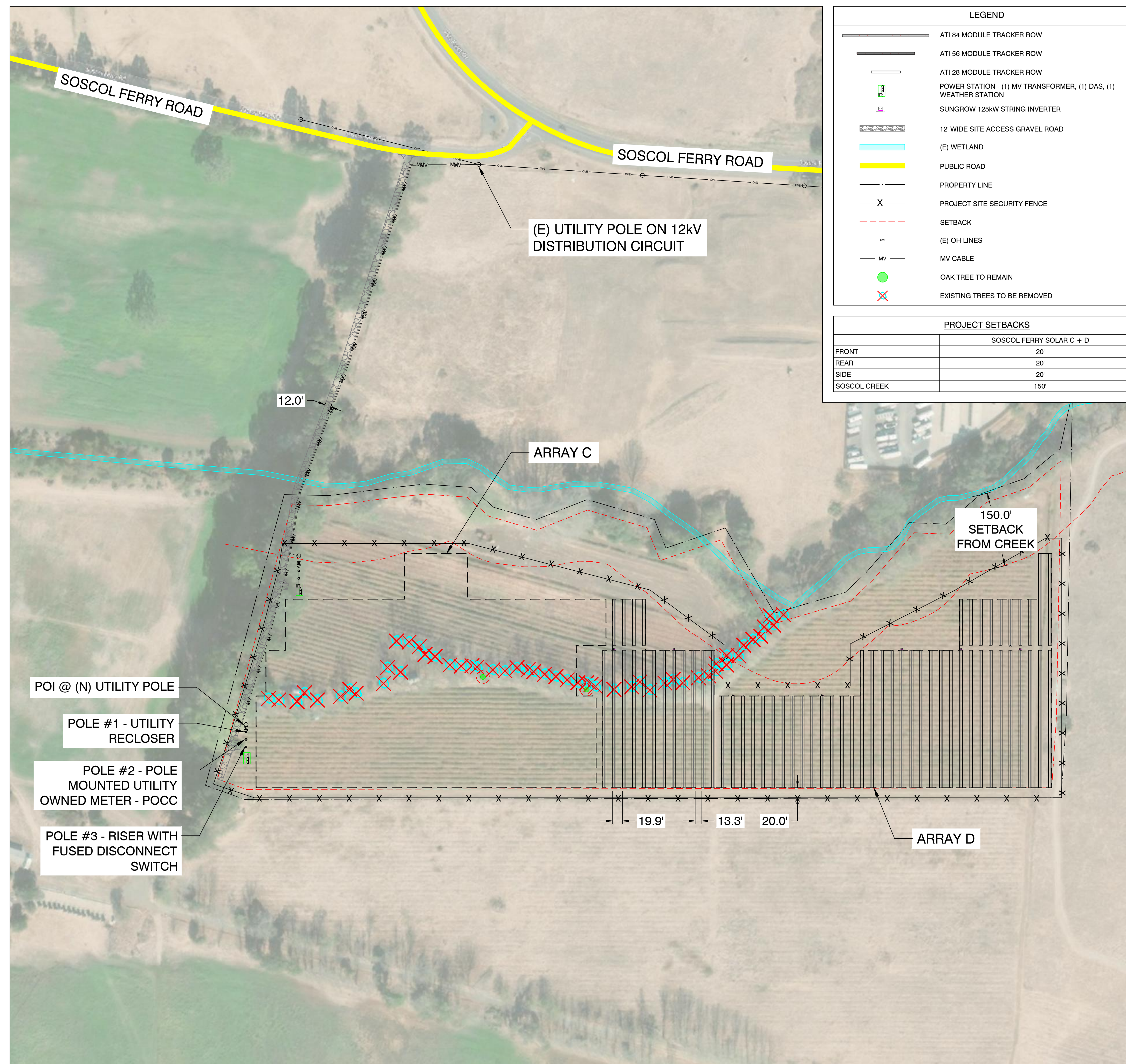

LEGEND

- AT1 84 MODULE TRACKER ROW
- AT1 56 MODULE TRACKER ROW
- AT1 28 MODULE TRACKER ROW
- ☐ POWER STATION - (1) MV TRANSFORMER, (1) DAS, (1) WEATHER STATION
- ☐ SUNGROW 125kW STRING INVERTER
- 12' WIDE SITE ACCESS GRAVEL ROAD
- (E) WETLAND
- PUBLIC ROAD
- PROPERTY LINE
- X — PROJECT SITE SECURITY FENCE
- — — SETBACK
- (E) OH LINES
- MV — MV CABLE
- OAK TREE TO REMAIN
- ✗ EXISTING TREES TO BE REMOVED

PROJECT SETBACKS

	SOSCOL FERRY SOLAR C + D
FRONT	20'
REAR	20'
SIDE	20'
SOSCOL CREEK	150'

SYSTEM SPECIFICATIONS

SOSCOL FERRY ROAD D	
SYSTEM SIZE DC	1,489.60 kW
SYSTEM SIZE AC	990.00 kW*
DC/AC RATIO	1.50
MODULE MANUFACTURER	TRINA SOLAR
MODULE MODEL	TSM-DE14H(II)
MODULE RATING	380 W
TOTAL MODULE QTY	3,920
MODULES PER STRING	28
TOTAL NO. OF STRINGS	140
INVERTER MODEL	SUNGROW SG125HV
INVERTER RATING	125 kW
INVERTER QTY	8
STEP-UP TRANSFORMER	12kV/600V, 1000kVA
RACKING	ATI HSAT
INTER-ROW SPACING	13.3'
PITCH	19.9'
GCR	33%
SITE AREA INSIDE FENCE	15.67 Ac

* PLANT NAMEPLATE LIMITED TO 990 kW AC AND IS CONFIGURED IN FACTORY BY INVERTER MANUFACTURER.

- GENERAL NOTES**
- REFER TO SINGLE LINE DIAGRAM FOR DETAILS.
 - INSTALLATION TO COMPLY WITH NEC 2014 ARTICLE 690 AND ALL APPLICABLE LOCAL, STATE AND NATIONAL CODES OR REGULATIONS.
 - EQUIPMENT SHALL BE LABELED PER NEC 690 AND UTILITY REGULATIONS.
 - 12' ACCESS ROADS SHALL BE DESIGNED TO ACCOMMODATE ALL CONSTRUCTION, OPERATIONS, MAINTENANCE, AND UTILITY TRAFFIC THROUGHOUT THE SITE.
 - DIMENSIONS TO PROPERTY LINES AND EXISTING FEATURES ARE APPROXIMATE PENDING SURVEY.
 - LANDSCAPING WILL BE COMPLIANT TO THE BIOLOGICAL CONSTRAINTS ANALYSIS FOR LANDSCAPING AND WATER EFFICIENT LANDSCAPE ORDINANCE.
 - ALL TOPOGRAPHY, ELEVATION INFORMATION, DRAINAGE PATTERNS AND COURSES ARE SUBJECT TO THE OUTCOME OF DRAINAGE CALCULATIONS AND STORM WATER DRAINAGE REPORT (NOT YET PERFORMED).
 - A 15.5' ACCESS CORRIDOR WILL BE PROVIDED WHICH WILL CONSIST OF 12' GRAVEL ROAD WITH 3' CLEARANCE BETWEEN ROAD AND FENCE.
 - THE CROSS SECTION OF THE PROPOSED 12 FT WIDE ROAD WILL MATCH THE EXISTING GRADE, WHICH SLOPES TOWARD THE PERIMETER FENCE. ROAD CROSS SECTIONS WILL BE DESIGNED TO DRAIN TOWARDS THE FENCE. FINAL CIVIL DESIGN WILL SPECIFY THE PROPOSED GRADES.



PRELIMINARY NOT FOR CONSTRUCTION

SOSCOL FERRY SOLAR D

1605, SOSCOL FERRY RD,
NAPA, CA 94559, USA

LAT: 38.237851°
LON: -122.275392°

REV. NO.	DESCRIPTION	DATE
0	FOR UTILITY APPLICATION	08/10/19

SHEET TITLE:

PRELIMINARY LAYOUT

DRAWING NO.:

PV-102

DRAWN BY:

LR

REVIEWED BY:

DATE:

08/10/19

SCALE:

AS SHOWN

PROJECT NO.:



PRELIMINARY
NOT FOR
CONSTRUCTION

SOSCOL FERRY
SOLAR D

1605, SOSCOL FERRY RD,
NAPA, CA 94559, USA

LAT: 38.237851°
LON: -122.275392°

REV. NO	DESCRIPTION	DATE
0	FOR UTILITY APPLICATION	08/10/19

SHEET TITLE:

SINGLE LINE
DIAGRAM

DRAWING NO.:

E-102

DRAWN BY:

LR

REVIEWED BY:

DATE:

08/10/19

SCALE:

AS SHOWN

PROJECT NO.:

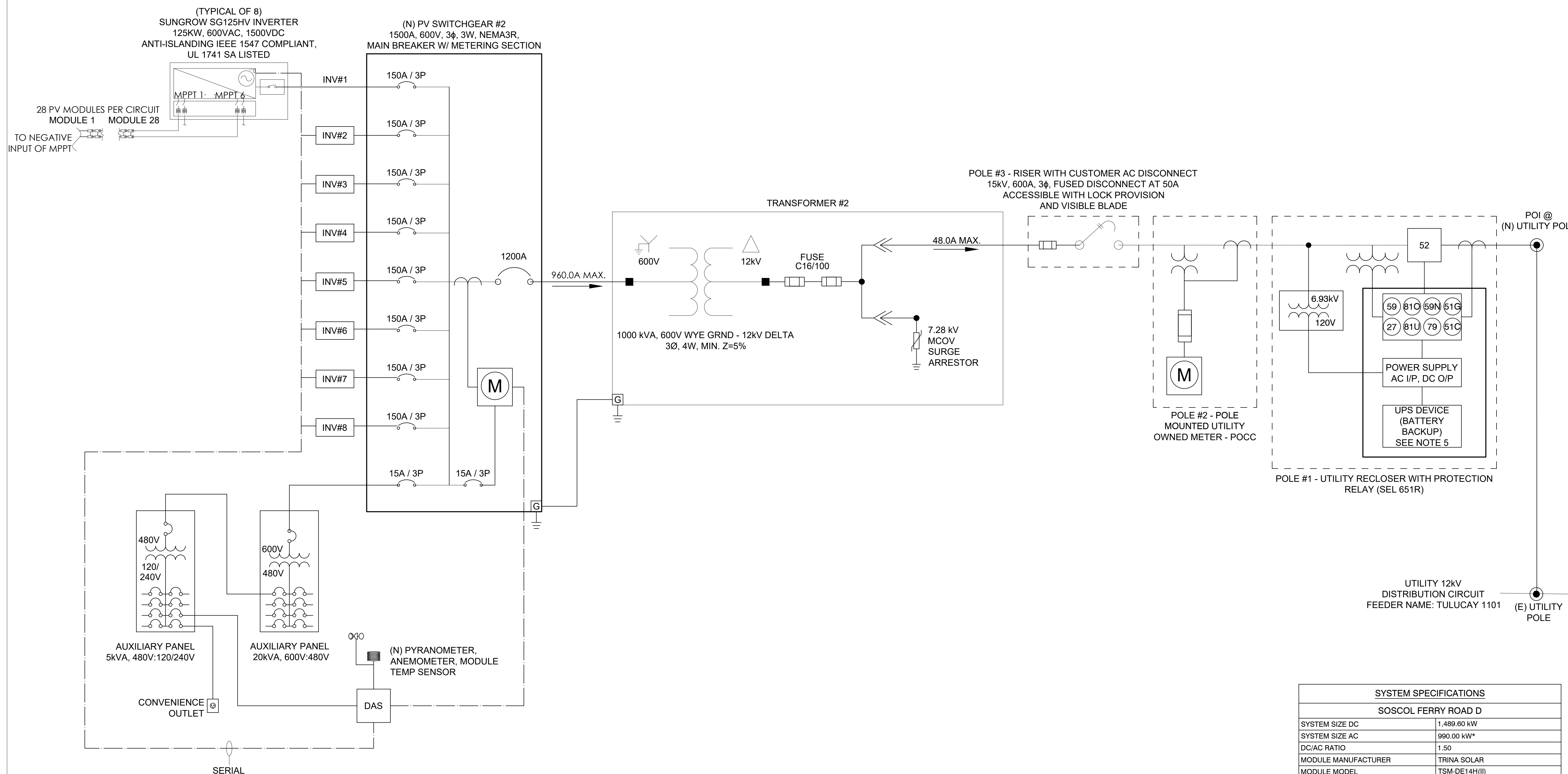

1 SOSCOL FERRY ROAD D SINGLE LINE DIAGRAM

SYSTEM SPECIFICATIONS	
SOSCOL FERRY ROAD D	
SYSTEM SIZE DC	1,489.60 kW
SYSTEM SIZE AC	990.00 kW*
DC/AC RATIO	1.50
MODULE MANUFACTURER	TRINA SOLAR
MODULE MODEL	TSM-DE14H(II)
MODULE RATING	380 kW
TOTAL MODULE QTY	3,920
MODULES PER STRING	28
TOTAL NO. OF STRINGS	140
INVERTER MODEL	SUNGROW SG125HV
INVERTER RATING	125 kW
INVERTER QTY	8
STEP-UP TRANSFORMER	12kV/600V, 1000kVA

* PLANT NAMEPLATE LIMITED TO 990 kW AC AND IS CONFIGURED IN FACTORY BY INVERTER MANUFACTURER.

- GENERAL NOTES**
- AC MV CIRCUITS SHALL BE INSTALLED AND INTERCONNECTED WITH UTILITY, PER UTILITY SPECIFICATIONS.
 - ALL ELECTRICAL WORK SHALL BE IN ACCORDANCE WITH THE 2014 EDITION OF NATIONAL ELECTRIC CODE.
 - ALL DC AND AC EQUIPMENT, WHERE APPLICABLE, SHALL BE LISTED AND LABELED PER RECOGNIZED ELECTRICAL TESTING LABORATORY AND INSTALLED PER THE LISTING REQUIREMENTS, THE MANUFACTURER'S INSTRUCTIONS AND IN ACCORDANCE WITH NEC.
 - RECLOSER CONTROL SETTINGS TO BE COORDINATED WITH UTILITY AND CONTRACTOR.
 - RELAY TO BE PROVIDED WITH 8-HOUR BATTERY BACK-UP.