

“J”

Traffic Study



Traffic Impact Study for the Shadybrook Estate Winery and Rapp Equestrian Center



Prepared for the County of Napa

Submitted by
W-Trans

November 26, 2019



**TRAFFIC ENGINEERING
TRANSPORTATION PLANNING**
Balancing Functionality and Livability since 1995
w-trans.com



This page intentionally left blank

Table of Contents

Executive Summary	1
Introduction	2
Transportation Setting	4
Capacity Analysis	6
Access and Circulation	20
Conclusions and Recommendations	21
Study Participants and References	22

Figures

1. Study Area and Existing Lane Configurations	3
2. Existing Traffic Volumes	9
3. Future Traffic Volumes	11
4. Shadybrook Estate Winery Site Plan	13
5. Rapp Equestrian Center Site Plan	14
6. Project Traffic Volumes	16

Tables

1. Collision Rates at the Study Intersections	5
2. Two-Way Stop-Controlled Intersection Level of Service Criteria	6
3. Existing Peak Hour Intersection Levels of Service	8
4. Future Peak Hour Intersection Levels of Service	10
5. Trip Generation Summary	15
6. Trip Distribution Assumptions	15
7. Existing and Existing plus Project Peak Hour Intersection Levels of Service	17
8. Future and Future plus Project Peak Hour Intersection Levels of Service	18
9. VMT Summary	18

Appendices

- A. Collision Records and Collision Rate Calculations
- B. Traffic Count Data
- C. Intersection Level of Service Calculations
- D. Trip Generation Spreadsheets





This page intentionally left blank

Executive Summary

Shadybrook Estate Winery seeks to modify the existing Conditional Use Permit to allow for an increase in production from 30,000 to 70,000 gallons annually and an increase in peak visitation from 21 to 50 daily visitors. An increase in the number of employees from two full-time and one-part time to nine full-time and two-part time is also proposed. Further, the Use Permit Modification includes an increase in the special event allowance from eight events with 30 attendees to six events with 30 attendees, six with 50 attendees, and six with up to 100 attendees annually. Marketing event hours are from 11:00 a.m. to 10:00 p.m. Events with 50 visitors or less would be catered using the existing on-site commercial kitchen, while catering for larger events would occur off-site.

Adjacent to the Shadybrook Estate Winery, the existing Rapp Equestrian Center seeks to obtain a Conditional Use Permit to authorize existing staffing, visitation, and marketing events for commercial horse boarding, riding, and lessons. The facility accommodates 60 horses with no proposed change being requested. The maximum number of horses on-site will not exceed sixty. The number of daily guests will not exceed 50 and staffing is to remain at seven full-time and two-part time employees with no changes requested. Stable hands (two to three employees) arrive at 6:30 a.m. for feeding and stable-cleaning, while guest hours are from 8:00 a.m. to 8:00 p.m. Existing marketing events to be retained for the equestrian center currently include six events with 30 guests, six with 50 guests, and six with 100 guests.

Both the equestrian center and winery would host small, medium, and large sized events. These events would not occur on the same day and on days of a large event, typical visitation would be closed at the winery and equestrian center.

Using the County's winery trip generation assumptions, the proposed project would be expected to generate an average of 46 net new weekday trips, with 17 trips during the p.m. peak hour, and 44 net new weekend trips, with 25 trips during the weekend peak period. The Rapp Equestrian Center currently generates 64 daily trips, with 24 trips during the p.m. peak hour and 36 trips during the weekend peak hour; this would not change as a result of the Conditional Use Permit.

The study area included the intersections of First Avenue and Second Avenue with North Avenue and Coombsville Road. All four of the study intersections currently operate at acceptable service levels overall and on the minor street approaches during both peak hours and would be expected to continue doing so with the project.

Under anticipated future volumes with and without project-generated traffic, the intersections are expected to operate acceptably at LOS A or B overall and on the stop-controlled approaches during both peaks. Access to the site occurs via Rapp Lane. Sight lines along Second Avenue from the project access roadway are adequate. Left-turn lanes are not warranted, and therefore not recommended, at the project's access on Second Avenue.

It is recommended that the applicant establish a TDM plan to reduce trips during peak periods. Trip reduction measures could include promoting employee carpooling and providing lunch on-site for employees. Additionally, winery staff should encourage carpooling or the use of a shuttle/van when groups call to reserve tastings or tours.

Introduction

This report presents an analysis of the potential traffic impacts that would be associated with the proposed modification to the Conditional Use Permit for the Shadybrook Winery located at 10 Chateau Lane and the approval of a Conditions Use Permit for the adjacent Rapp Equestrian Center located at 100 Rapp Lane in the County of Napa. The traffic study was completed in accordance with the criteria established by the County of Napa, reflect a scope of work reviewed and approved by staff, and is consistent with standard traffic engineering techniques.

Prelude

The purpose of a traffic impact study is to provide County staff and policy makers with data they can use to make an informed decision regarding the potential traffic impacts of a proposed project, and any associated improvements that would be required to mitigate these impacts to a level of insignificance as defined by the County's General Plan or other policies. Vehicular traffic impacts are typically evaluated by determining the number of new trips that the proposed use would be expected to generate, distributing these trips to the surrounding street system based on existing travel patterns or anticipated travel patterns specific to the proposed project, then analyzing the impact the new traffic would be expected to have on critical intersections or roadway segments. Impacts relative to access for pedestrians, bicyclists, and to transit are also addressed.

Project Profile

The Shadybrook Estate Winery at 10 Chateau Lane is proposing a Conditional Use Permit (CUP) Modification to increase production, staffing levels, and daily tasting room visitation, as well as to adjust their special event allowance. The proposal would increase annual production from 30,000 to 70,000 gallons. The winery is currently permitted for two full-time and one part-time employees, 21 visitors per day, and eight events at up to 30 guests. The requested modification to the CUP proposes nine full-time and two part-time employees, a maximum of 50 visitors per day, and six events with 30 attendees, six with 50 attendees, and six with up to 100 attendees annually. Catering for events with 50 attendees or less would occur on-site while food preparation for larger events would be off-site. The applicant proposes no additional parking, but a reconfiguration of the existing parking and landscaping. Also proposed is an increase of winery production area in a portion of the existing barn. The winery would continue to operate seven days a week from 9:00 a.m. to 5:00 p.m.

Also, part of the proposed project, the existing Rapp Equestrian Center at 100 Rapp Lane is in the process of obtaining a Conditional Use Permit to allow continued operation of the equestrian center, which currently has seven full-time and two-part time employees and a maximum of 50 daily visitors. The center's requested annual event allowance includes six events with 30 guests, six with 50 guests, and six events with 100 guests. The equestrian center operates seven days a week from 8:00 a.m. to 8:00 p.m. The location of the project site is shown in Figure 1.

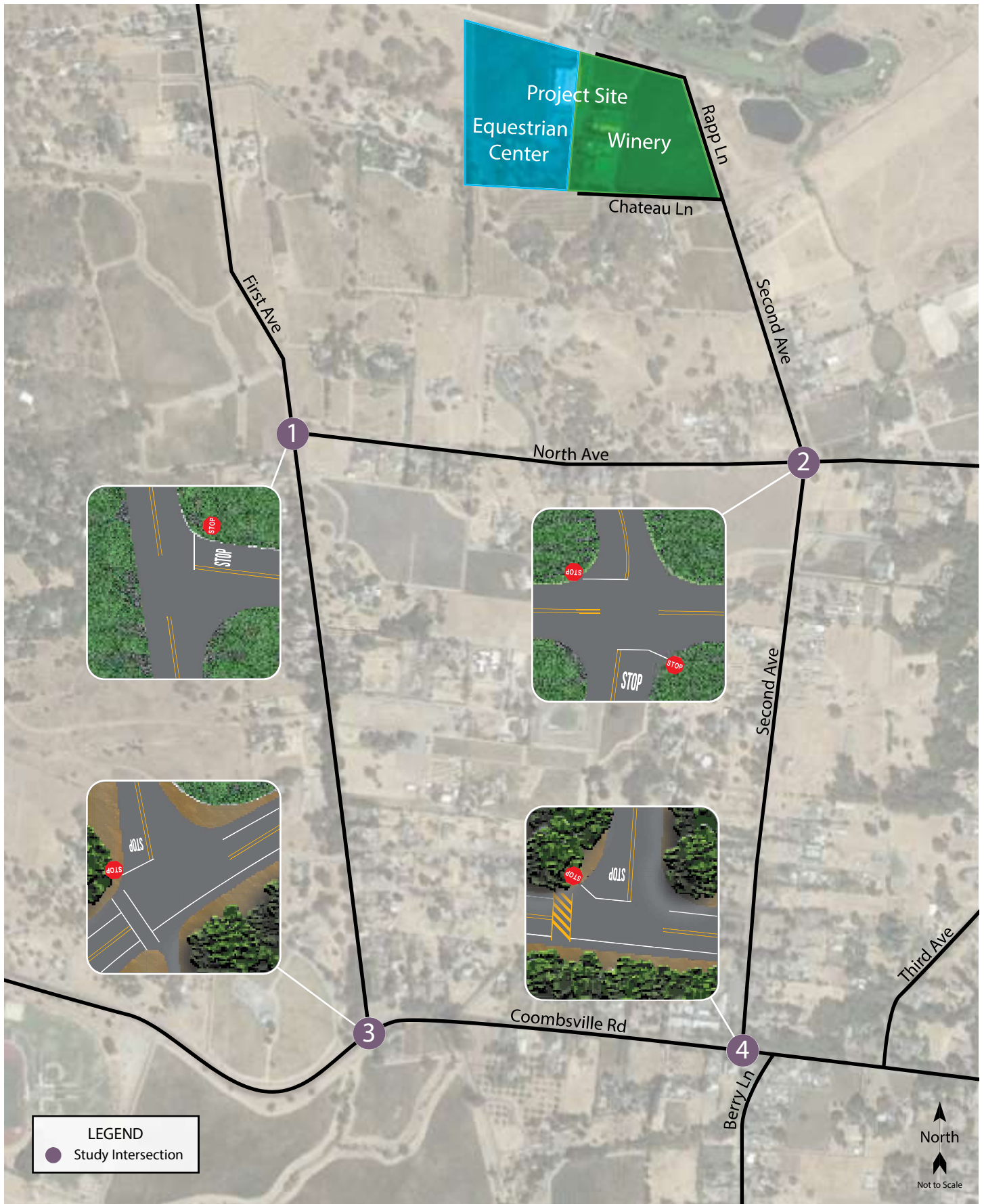

Traffic Impact Study for the Shadybrook Estate Winery and Rapp Equestrian Center
Figure 1 – Study Area and Existing Lane Configurations

Transportation Setting

Operational Analysis

Study Area and Periods

The study area requested by County staff consists of the following intersections:

1. North Avenue/First Avenue
2. North Avenue/Second Avenue
3. Coombsville Road/First Avenue
4. Coombsville Road/Second Avenue

Operating conditions during the weekday and weekend p.m. peak periods were evaluated as these time periods reflect the highest traffic volumes areawide and for the proposed project. The evening peak hour occurs between 4:00 and 6:00 p.m. and typically reflects the highest level of congestion of the day during the homeward bound commute, while the weekend peak occurs between 1:45 p.m. and 2:45 p.m.

Study Intersections

North Avenue/First Avenue is a tee-intersection stop-controlled at the terminating westbound North Avenue approach.

North Avenue/Second Avenue is a four-legged intersection with stop controls at the northbound and southbound Second Avenue approaches. The northbound approach includes a flared right-turn lane.

Coombsville Road/First Avenue is a tee-intersection where the terminating southbound First Avenue approach is stop-controlled. There is a crosswalk marked across the west leg.

Coombsville Road/Second Avenue is a tee-intersection with a stop control at the terminating southbound Second Avenue approach. There is an existing high-visibility crosswalk on the west leg of the intersection and the southbound approach includes a flared right-turn lane.

The locations of the study intersections and the existing lane configurations and controls are shown in Figure 1.

Study Roadway

Second Avenue runs north to south and has two 12-foot travel lanes. The segment of Second Avenue between North Avenue and Coombsville Road has a posted speed limit of 40 miles per hour (mph). Based on count data obtained in March 2019, Second Avenue carries an average of approximately 310 vehicles per day north of North Avenue. Per the 2012 *Napa County Bicycle Plan*, there is a planned Class III bike route on Second Avenue from Coombsville Road to North Avenue. Additionally, there are planned Class III bike routes on nearby roads including First Avenue from Coombsville Road to Hagen Road, Coombsville Road-Wild Horse Valley Road from Silverado Middle School to the Solano County line, and on North Avenue from First Avenue to Third Avenue.

Collision History

The collision history for the study area was reviewed to determine any trends or patterns that may indicate a safety issue. Collision rates were calculated based on records available from the California Highway Patrol as published in their Statewide Integrated Traffic Records System (SWITRS) reports. The most current five-year period available is April 1, 2014 through March 31, 2019.

As presented in Table 1, the calculated collision rates for the study intersections were compared to average collision rates for similar facilities statewide, as indicated in *2014 Collision Data on California State Highways*, California Department of Transportation (Caltrans). The calculated collision rate for the intersection of Coombsville Road/Second Avenue is lower than the statewide average for similar facilities, indicating that this intersection is operating within acceptable safety parameters. It is noted that three of the four study intersections experienced collisions at rates higher than the statewide averages for similar facilities. The collision records and collision rate calculations are provided in Appendix A.

Table 1 – Collision Rates at the Study Intersections

Study Intersection	Number of Collisions (2014-2019)	Calculated Collision Rate (c/mve)	Statewide Average Collision Rate (c/mve)
1. North Ave/First Ave	1	0.24	0.16
2. North Ave/Second Ave	2	1.10	0.23
3. Coombsville Rd/First Ave	2	0.26	0.16
4. Coombsville Rd/Second Ave	0	0.00	0.16

Note: c/mve = collisions per million vehicles entering; **Bold** text indicates an above-average collision rate

Because the collision rates for all but Coombsville Road/Second Avenue were higher than the statewide averages, the crashes at these locations were reviewed in greater detail.

North Avenue/First Avenue experienced one collision over the five-year study period, which translates to a collision rate of 0.24 collisions per million vehicles entering (c/mve) the intersection. While this is higher than the statewide average of 0.16 c/mve for similar facilities, given the very low volumes it takes only one collision to exceed the statewide average rate. Similarly, this is the case for the intersections of North Avenue/Second Avenue and Coombsville Road/First Avenue, which both experienced two collisions over the five-year study period. Further, it is noted that none of the collisions at any of the three intersections resulted in injuries. The limited number of collisions that have occurred in five years at the three study intersections does not appear to indicate a safety concern; therefore, the above-average collision rates are not considered a safety concern.

Collisions that occurred along the segment of Second Avenue between the project site and North Avenue were also evaluated. Over the same five-year period, zero collisions were recorded along the segment, suggesting that traffic operation along Second Avenue north of North Avenue is operating within acceptable safety parameters.

Capacity Analysis

Intersection Level of Service Methodologies

Level of Service (LOS) is used to rank traffic operation on various types of facilities based on traffic volumes and roadway capacity using a series of letter designations ranging from A to F. Generally, Level of Service A represents free flow conditions and Level of Service F represents forced flow or breakdown conditions. A unit of measure that indicates a level of delay generally accompanies the LOS designation.

The study intersections were analyzed using the “Two-Way Stop-Controlled” methodology published in the *Highway Capacity Manual* (HCM), 6th Edition, Transportation Research Board, 2018. This source contains methodologies for various types of intersection control, all of which are related to a measurement of delay in average number of seconds per vehicle. The “Two-Way Stop-Controlled” intersection capacity methodology determines a level of service for each minor turning movement by estimating the level of average delay in seconds per vehicle. Results are presented for individual movements together with the weighted overall average delay for the intersection.

The ranges of delay associated with the various levels of service are indicated in Table 2.

Table 2 – Two-Way Stop-Controlled Intersection Level of Service Criteria

LOS A	Delay of 0 to 10 seconds. Gaps in traffic are readily available for drivers exiting the minor street.
LOS B	Delay of 10 to 15 seconds. Gaps in traffic are somewhat less readily available than with LOS A, but no queuing occurs on the minor street.
LOS C	Delay of 15 to 25 seconds. Acceptable gaps in traffic are less frequent, and drivers may approach while another vehicle is already waiting to exit the side street.
LOS D	Delay of 25 to 35 seconds. There are fewer acceptable gaps in traffic, and drivers may enter a queue of one or two vehicles on the side street.
LOS E	Delay of 35 to 50 seconds. Few acceptable gaps in traffic are available, and longer queues may form on the side street.
LOS F	Delay of more than 50 seconds. Drivers may wait for long periods before there is an acceptable gap in traffic for exiting the side streets, creating long queues.

Reference: *Highway Capacity Manual*, 6th Edition, Transportation Research Board, 2018

Traffic Operation Standards

In the Circulation Element of the *Napa County General Plan*, the following policies have been adopted:

- **Policy CIR-31** – *The County seeks to provide a roadway system that maintains current roadway capacities in most locations and is both safe and efficient in terms of providing local access.*
- **Policy CIR-38** – *The County seeks to maintain operations of roads and intersections in the unincorporated County area that minimize travel delays and promote safe access for all users. Operational analysis shall be conducted according to the latest version of the Highway Capacity Manual and as described in the current version of the County’s Transportation Impact*

Study Guidelines. In general, the County seeks to maintain Level of Service (LOS) D on arterial roadways and at signalized intersections, as the service level that best aligns with the County's desire to balance its rural character with the needs of supporting economic vitality and growth.

To provide a more quantitative method of adhering to the above standards, the County refers to *Guidelines for Interpretation of General Plan Circulation Policies on Significance Criteria* (Fehr & Peers, 2015). The document establishes thresholds of significance for road segments and different intersection control types. The memorandum states a project would cause a significant impact requiring mitigation if, for existing conditions:

- *A signalized intersection operates at LOS A, B, C, or D during the selected peak hours without Project trips, and the LOS deteriorates to LOS E or F with the addition of Project trips; or*
- *A signalized intersection operates at LOS E or F during the selected peak hours without Project trips, and the addition of Project trips increases the total entering volume by one percent or more.*
 - *Project Contribution % = Project Trips ÷ Existing Volumes*
- *An unsignalized intersection operates at LOS A, B, C, or D during the selected peak hours without Project trips, and the LOS deteriorates to LOS E or F with the addition of Project traffic; the peak hour traffic signal warrant criteria should also be evaluated and presented for informational purposes; or*
- *An unsignalized intersection operates at LOS E or F during the selected peak hours without Project trips, and the project contributes one percent or more of the total entering traffic for all-way stop-controlled intersections, or ten percent or more of the traffic on a side-street approach for side-street stop-controlled intersections; the peak hour traffic signal criteria should also be evaluated and presented for informational purposes. Both of those volumes are for the stop-controlled approaches only. Each stop-controlled approach that operates at LOS E or F should be analyzed individually*
 - *All-Way Stop-Controlled Intersections* – *The following equation should be used if the all-way stop-controlled intersection operates at LOS E or F without the Project:*
 - *Project Contribution % = Project Trips ÷ Existing Volumes*
 - *Side-Street Stop-Controlled Intersections* – *The following equation should be used if the side-street stop-controlled intersection operates at LOS E or F without the Project:*
 - *Project Contribution % = Project Trips ÷ Existing Volumes*
- *An arterial segment operates at LOS A, B, C or D during the selected peak hours without Project trips, and deteriorates to LOS E or F with the addition of Project trips; or*
- *An arterial segment operates at LOS E or F during the selected peak hours without Project trips, and the addition of Project trips increases the total segment volume by one percent or more. The following equation should be used if the arterial segment operates at LOS E or F without the Project:*
 - *Project Contribution % = Project Trips ÷ Existing Volumes*

Further, a project would cause a significant impact requiring mitigation if, for cumulative (future) conditions, the Project's volume is equal to, or greater than five percent of the difference between cumulative (future) and existing volumes.

- Cumulative Conditions – A Project's contribution to a cumulative condition would be calculated as the Project's percentage contribution to the total growth in traffic. This calculation applies to arterials, signalized intersections, and unsignalized intersections.
 - $Project\ Contribution\ \% = Project\ Trips \div (Cumulative\ Volumes - Existing\ Volumes)$

Existing Conditions

The Existing Conditions scenario provides an evaluation of current operation based on existing traffic volumes during the weekday and weekend p.m. peak periods. This condition does not include project-generated traffic volumes except as exists due to the ongoing operation of the Equestrian Center. Volume data was collected in July 2019. Copies of the intersection turning movement counts are provided in Appendix B.

Intersection Levels of Service

Under existing conditions, all four study intersections are operating at acceptable LOS A or B overall and on the stop-controlled approaches during the weekday and weekend peak periods. A summary of the intersection level of service calculations is contained in Table 3, and copies of the Level of Service calculations are provided in Appendix C. The existing traffic volumes are shown in Figure 2.

Table 3 – Existing Peak Hour Intersection Levels of Service				
Study Intersection <i>Approach</i>	Weekday PM Peak		Weekend PM Peak	
	Delay	LOS	Delay	LOS
1. North Ave/First Ave	2.9	A	3.4	A
<i>Westbound (North Ave) Approach</i>	<i>9.2</i>	<i>A</i>	<i>8.9</i>	<i>A</i>
2. North Ave/Second Ave	3.4	A	4.1	A
<i>Northbound (Second Ave) Approach</i>	<i>9.1</i>	<i>A</i>	<i>9.0</i>	<i>A</i>
<i>Southbound (Second Ave) Approach</i>	<i>9.1</i>	<i>A</i>	<i>9.0</i>	<i>A</i>
3. Coombsville Rd/First Ave	3.3	A	3.0	A
<i>Southbound (First Ave) Approach</i>	<i>10.6</i>	<i>B</i>	<i>9.6</i>	<i>A</i>
4. Coombsville Rd/Second Ave	1.4	A	1.3	A
<i>Southbound (Second Ave) Approach</i>	<i>9.2</i>	<i>A</i>	<i>9.1</i>	<i>A</i>

Notes: Delay is measured in average seconds per vehicle; LOS = Level of Service; Results for minor approaches to two-way stop-controlled intersections are indicated in *italics*

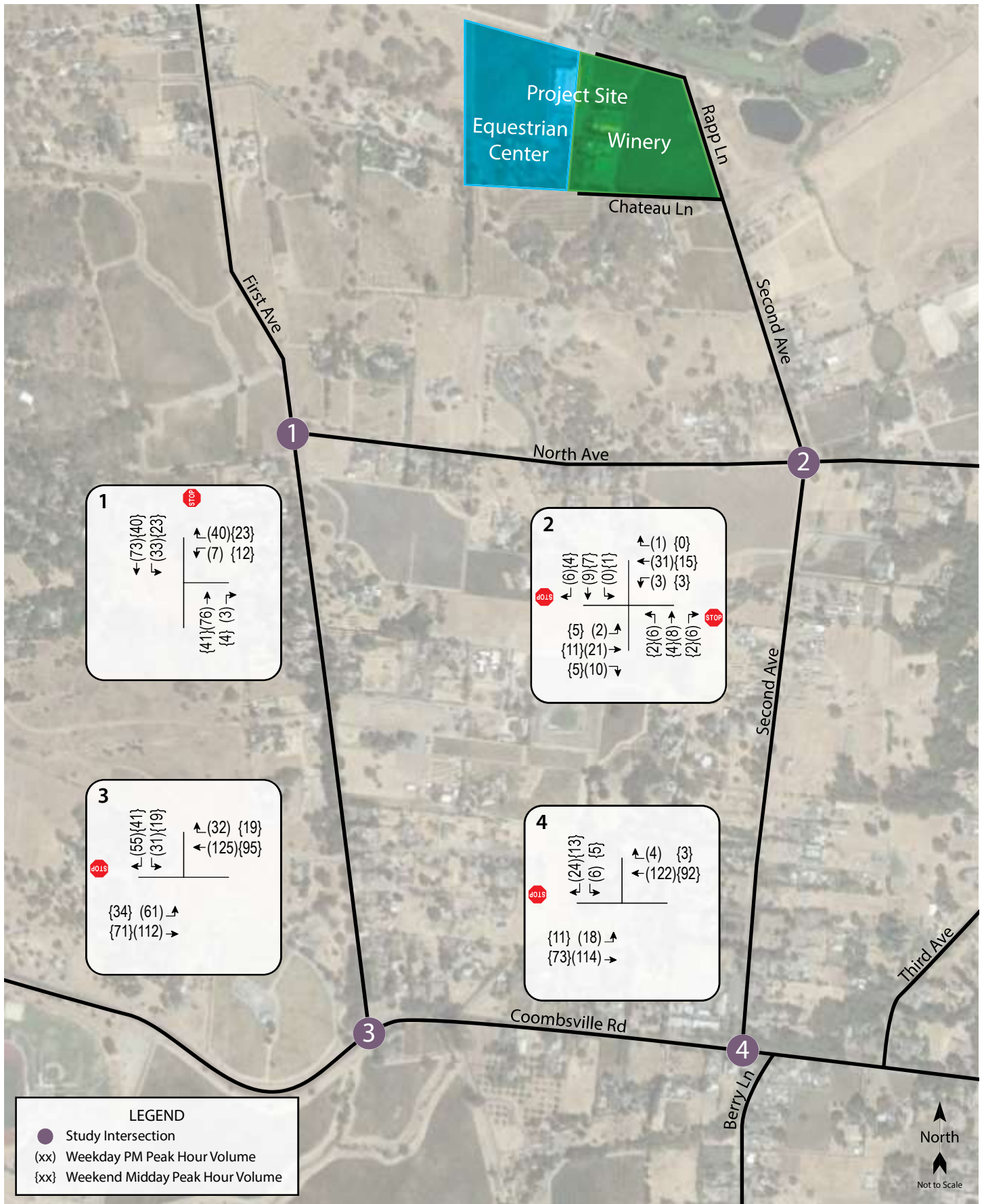

Traffic Impact Study for the Shadybrook Estate Winery and Rapp Equestrian Center
Figure 2 – Existing Traffic Volumes

Future Conditions

Future volumes for the horizon year 2040 were calculated based on output from the *Napa Solano Travel Demand Model*, maintained by the Solano Transportation Authority (STA). Base year (2015) and future (2040) segment volumes for the weekday p.m. peak period were used to calculate growth factors for the study intersections and roadway segments.

The same growth factors used for the weekday p.m. peak hour were used for the weekend peak hour as the model does not contain information for weekend days. Volumes at the intersection of Coombsville Road and First Avenue are expected to grow by a factor of 1.14; however, there are no projected growth volumes in the *Napa Solano Travel Demand Model* for the remaining three study intersections. Given that the intersection of Coombsville Road/First Avenue experiences the largest traffic volumes of the four study intersections under existing conditions and because it connects downtown Napa and the outer area east of it, it is reasonable to assume that the application of the 1.14 growth factor at Coombsville Road/First Avenue to the other three study intersections would be a conservative assumption. Therefore, the growth factor of 1.14 was applied to project future volumes at all four study intersections during both study periods.

Under the anticipated Future volumes, the study intersections are expected to continue operating acceptably at LOS A or B overall and on the minor side-street approaches during both peak periods. Operating conditions are summarized in Table 4 and Future volumes are shown in Figure 3.

Table 4 – Future Peak Hour Intersection Levels of Service

Study Intersection <i>Approach</i>	Weekday PM Peak		Weekend PM Peak	
	Delay	LOS	Delay	LOS
1. North Ave/First Ave	2.9	A	3.4	A
<i>Westbound (North Ave) Approach</i>	<i>9.1</i>	<i>A</i>	<i>9.0</i>	<i>A</i>
2. North Ave/Second Ave	3.4	A	4.0	A
<i>Northbound (Second Ave) Approach</i>	<i>9.1</i>	<i>A</i>	<i>9.0</i>	<i>A</i>
<i>Southbound (Second Ave) Approach</i>	<i>9.1</i>	<i>A</i>	<i>9.0</i>	<i>A</i>
3. Coombsville Rd/First Ave	3.3	A	3.0	A
<i>Southbound (First Ave) Approach</i>	<i>10.7</i>	<i>B</i>	<i>9.6</i>	<i>A</i>
4. Coombsville Rd/Second Ave	1.4	A	1.3	A
<i>Southbound (Second Ave) Approach</i>	<i>9.3</i>	<i>A</i>	<i>9.1</i>	<i>A</i>

Notes: Delay is measured in average seconds per vehicle; LOS = Level of Service; Results for minor approaches to two-way stop-controlled intersections are indicated in *italics*

Project Description

The project is a change in use at an existing winery facility, including an increase in production from 30,000 to 70,000 gallons per year. The number of employees would increase from two full-time and one part-time to nine full-time and two part-time to accommodate the increase in visitation from 21 to 50 visitors

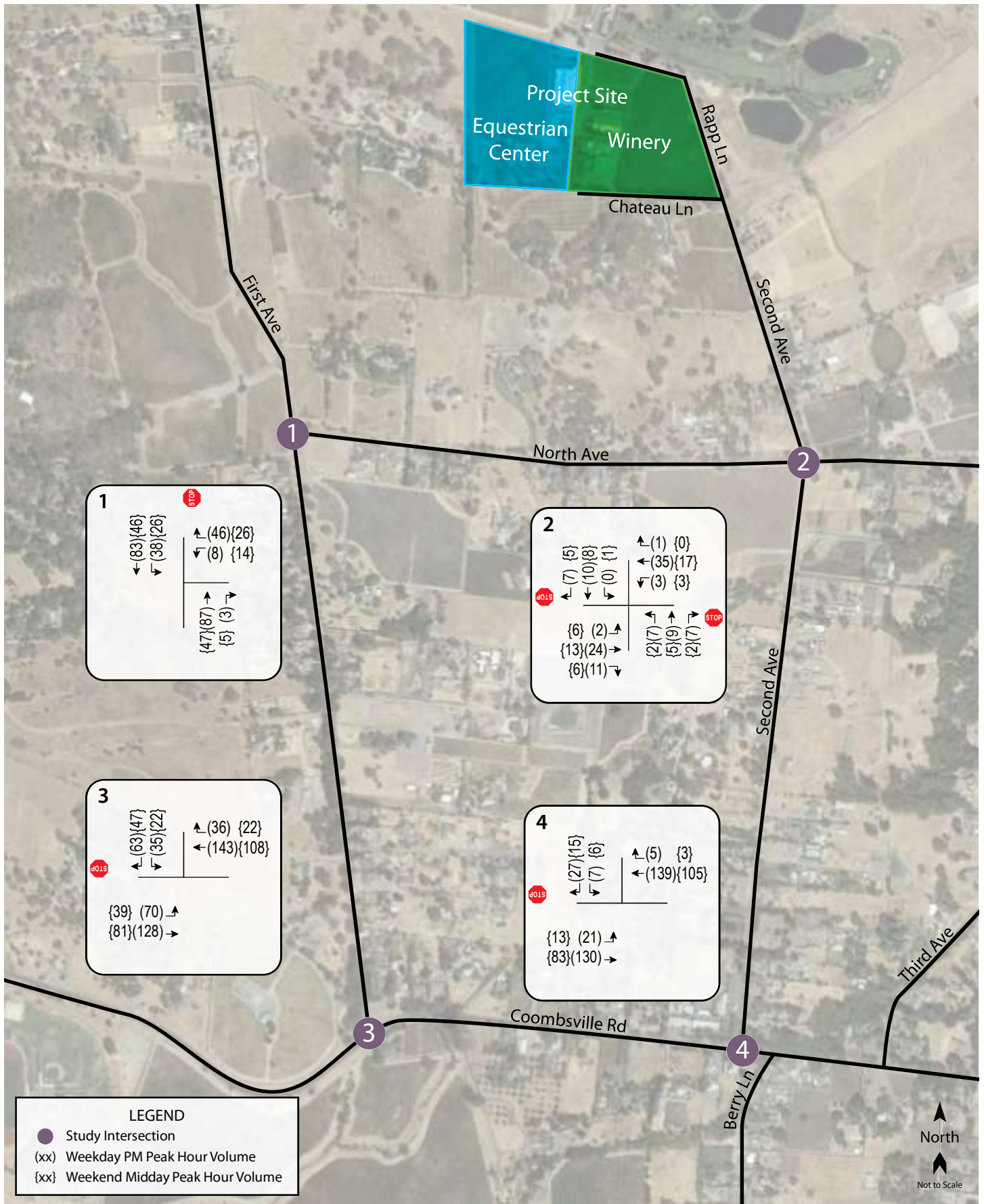

Traffic Impact Study for the Shadybrook Estate Winery and Rapp Equestrian Center
Figure 3 – Future Traffic Volumes

per day. The proposal would modify the winery's annual event allowance from eight events with 30 attendees to six events with 30 guests, six events with 50 guests, and six events with 100 guests.

The project also includes a request for approval of a Conditional Use Permit for the existing Rapp Equestrian Center located adjacent to the Shadybrook Estate Winery. The CUP would allow continued operation of the equestrian center, which currently has a staff of seven full-time and two part-time employees to accommodate 50 visitors per day. Marketing events for the equestrian center currently include six events with 30 visitors, six with 50 visitors, and six with 100 visitors annually. Events for the equestrian center and winery would not occur on the same day and on days of 100-person events, no visitation to the winery or equestrian center would be scheduled. The proposed project site plans are shown in Figures 4 and 5.

Trip Generation

The County of Napa's Winery Traffic Information/Trip Generation Sheet was used to determine the anticipated trip generation for the permitted and proposed conditions for the Shadybrook Estate Winery and for the existing condition for the Rapp Equestrian Center. The form estimates the number of daily trips for weekdays and Saturdays based on the number of full- and part-time employees, maximum daily visitors, and production. It is noted that the winery is currently producing less wine than permitted, though this does not affect the daily trip generation except during crush. Copies of the worksheets for Permitted, Existing, and Proposed conditions are provided in Appendix D.

As the County of Napa's Winery Traffic Information/Trip Generation Sheet does not include guidance on inbound versus outbound trips during the peak hours, it was assumed that two-thirds of trip ends at the winery and equestrian center would be outbound during the weekday p.m. peak hour since most of the trips would be associated with employees and customers leaving at closure. For the Saturday peak-hour it was assumed that inbound and outbound trip ends would be evenly split.

Based on the number of employees and daily visitation, the equestrian center currently generates 24 trips during the weekday evening peak and 35 trips during the weekend peak. With no change to the operation of the equestrian center, no net new trips are anticipated. Based on the change in production, visitation, and employees, the winery would be expected to generate 27 trips during the weekday p.m. peak hour compared to 10 trips for conditions under the current permit. Similarly, during the weekend peak hour the increase in visitation would result in 38 trips, while there are 13 trips currently permitted. As shown in Table 5, this would result in a net increase of 46 trips per weekday, including 17 trips during the weekday p.m. peak hour and 25 trips during the weekend p.m. peak hour. These trips represent the increase in traffic associated with the proposed Conditional Use Permit above permitted conditions and are conservatively estimated from the maximum proposed daily visitation, which is not expected to occur on a frequent basis, as well as the current ratios of peak hour to daily trips, which substantially exceed the ratios documented through counts at numerous wineries in Napa County and are subject to change.

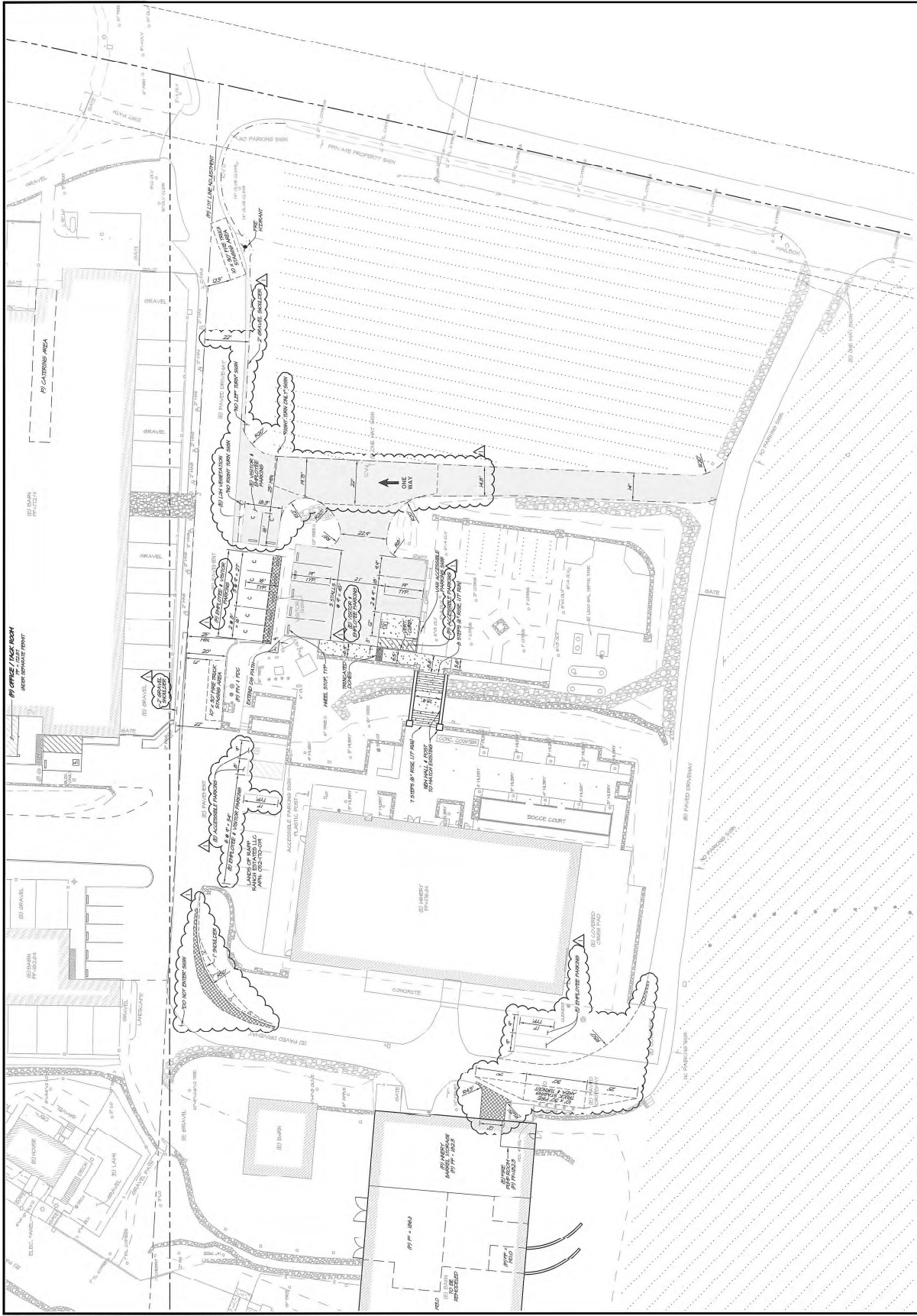

PARKING SUMMARY

PI STANDARD	8
PI ADA	1
PI STANDARD	8
PI CORNER	7
PI ADA	1
TOTAL	25

HATCH LEGEND

[Dotted Hatch]	GRAVEL - HANSEN 6" CLASS II AD
[Solid Hatch]	CONCRETE
[Diagonal Hatch]	DECOMPOSED GRANITE
[Cross-hatch]	ASPHALT CONCRETE



Traffic Impact Study for the Shadybrook Estate Winery and Rapp Equestrian Center
Figure 4 – Shadybrook Estate Winery Site Plan



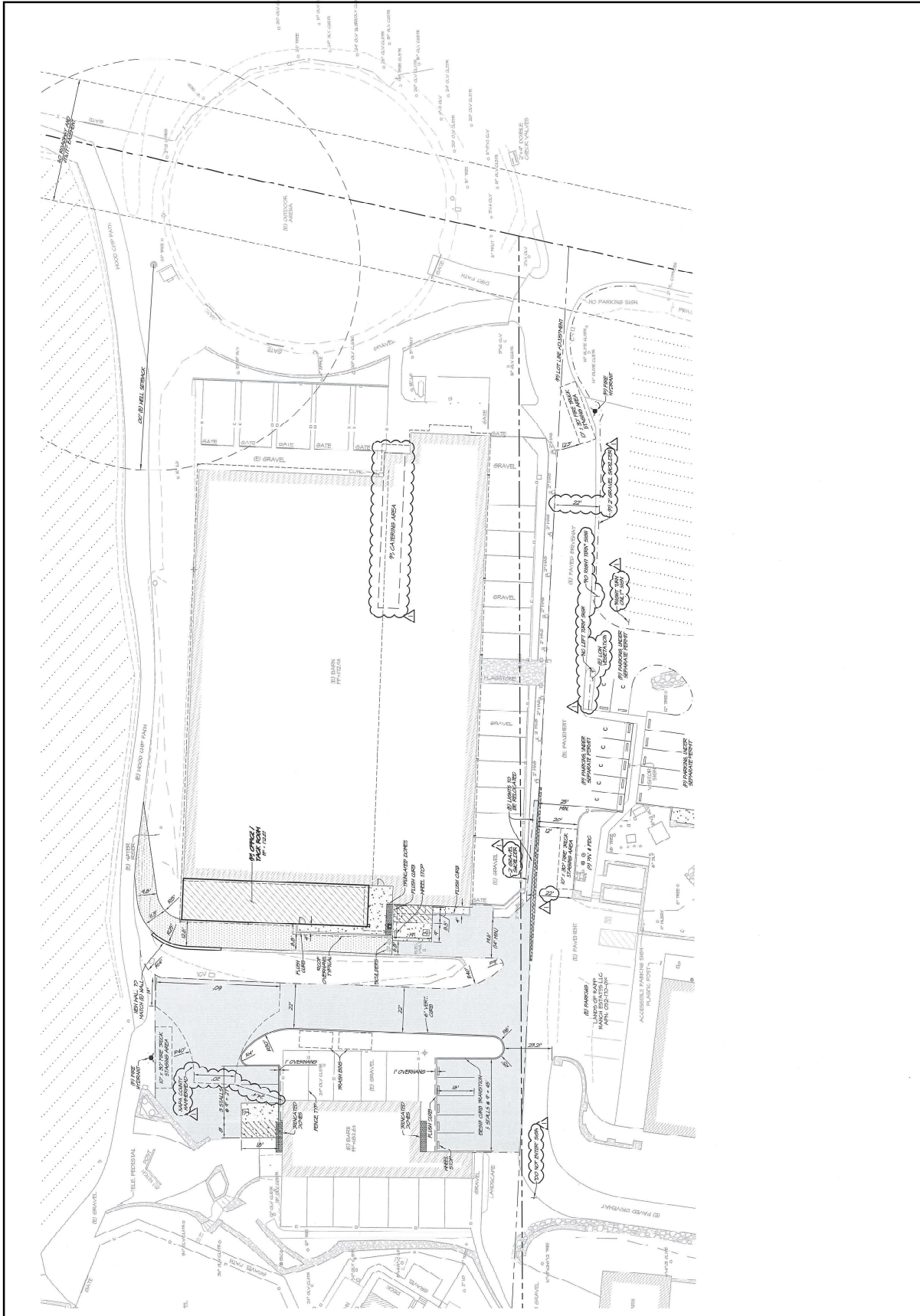

Traffic Impact Study for the Shadybrook Estate Winery and Rapp Equestrian Center
Figure 5 – Rapp Equestrian Center Site Plan



Table 5 – Trip Generation Summary

Scenario	Daily		Weekday PM Peak Hour			Weekend PM Peak Hour		
	Weekday	Weekend	Trips	In	Out	Trips	In	Out
Rapp Equestrian Center								
Existing	64	61	24	8	16	35	12	23
Shadybrook Winery								
Permitted	25	23	10	3	7	13	6	7
Proposed	71	67	27	9	18	38	19	19
Net Increase	46	44	17	6	11	25	13	12

Note: Trip generation as estimated above does not include special events

Trip Distribution

The pattern used to allocate new project trips to the street network was determined based on familiarity with the area and surrounding region as well as likely origins and destinations for patrons of the project. The applied distribution assumptions and resulting trips are shown in Table 6.

Table 6 – Trip Distribution Assumptions

Route	Percent
From/to north via First Ave	35
From/to west via Coombsville Rd	50
From/to east via North Ave	5
From/to east via Coombsville Rd	10
TOTAL	100

Intersection Operation

Existing plus Project Conditions

Upon adding project-related traffic to the Existing volumes, the study intersections are expected to continue operating acceptably at the same levels of service during both peak periods. Project traffic volumes are shown in Figure 6. These results are summarized in Table 7.

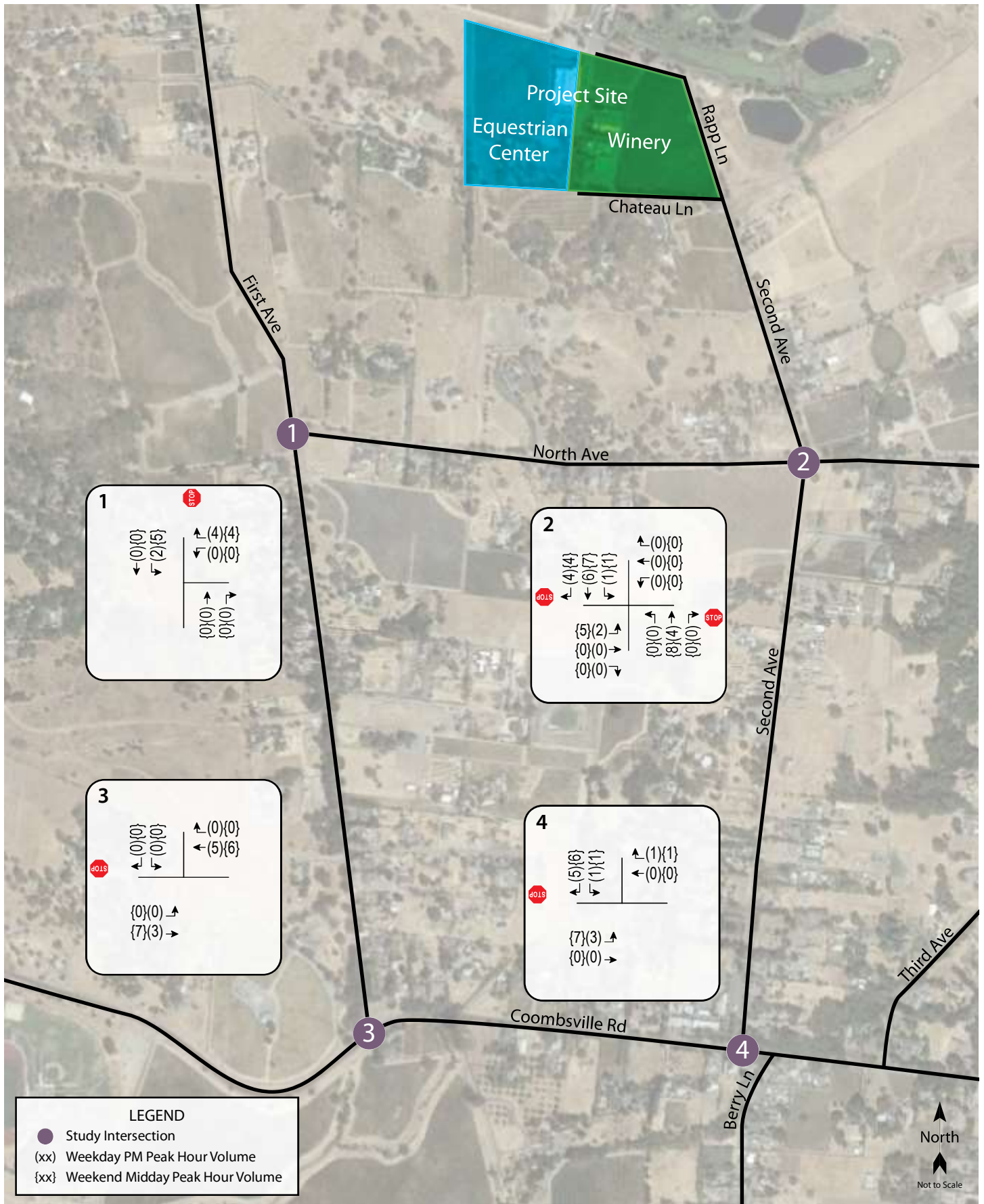

Traffic Impact Study for the Shadybrook Estate Winery and Rapp Equestrian Center
Figure 6 – Project Traffic Volumes

Table 7 – Existing and Existing plus Project Peak Hour Intersection Levels of Service

Study Intersection <i>Approach</i>	Existing Conditions				Existing plus Project			
	Weekday PM Peak		Weekend PM Peak		Weekday PM Peak		Weekend PM Peak	
	Delay	LOS	Delay	LOS	Delay	LOS	Delay	LOS
1. North Ave/First Ave	2.9	A	3.4	A	3.1	A	3.6	A
<i>Westbound (North Ave) Approach</i>	<i>9.2</i>	<i>A</i>	<i>8.9</i>	<i>A</i>	<i>9.2</i>	<i>A</i>	<i>8.9</i>	<i>A</i>
2. North Ave/Second Ave	3.4	A	4.1	A	4.2	A	5.5	A
<i>Northbound (Second Ave) Approach</i>	<i>9.1</i>	<i>A</i>	<i>9.0</i>	<i>A</i>	<i>9.2</i>	<i>A</i>	<i>9.3</i>	<i>A</i>
<i>Southbound (Second Ave) Approach</i>	<i>9.1</i>	<i>A</i>	<i>9.0</i>	<i>A</i>	<i>9.2</i>	<i>A</i>	<i>9.2</i>	<i>A</i>
3. Coombsville Rd/First Ave	3.3	A	3.0	A	3.3	A	2.9	A
<i>Southbound (First Ave) Approach</i>	<i>10.6</i>	<i>B</i>	<i>9.6</i>	<i>A</i>	<i>10.7</i>	<i>B</i>	<i>9.7</i>	<i>A</i>
4. Coombsville Rd/Second Ave	1.4	A	1.3	A	1.6	A	1.7	A
<i>Southbound (Second Ave) Approach</i>	<i>9.2</i>	<i>A</i>	<i>9.1</i>	<i>A</i>	<i>9.3</i>	<i>A</i>	<i>9.1</i>	<i>A</i>

Notes: Delay is measured in average seconds per vehicle; LOS = Level of Service; Results for minor approaches to two-way stop-controlled intersections are indicated in *italics*

It should be noted that with the addition of project-related traffic volumes, average delay at the intersection of Coombsville Road/First Avenue slightly decreases during the p.m. peak hour. While this is counter-intuitive, this condition occurs when a project adds trips to movements that are currently underutilized or have delays that are below the intersection average, resulting in a better balance between approaches and lower overall average delay. The project adds traffic predominantly to the eastbound and westbound through movements, which have average delays that are lower than the average for the intersection as a whole, resulting in a slight reduction in the overall average delay.

Finding – The study intersections are expected to continue operating acceptably at the same levels of service with project-generated traffic as without it.

Future plus Project Conditions

Upon the addition of project-generated traffic to the anticipated Future volumes, the study intersections are expected to continue operating acceptably at LOS A overall and at LOS A or B on the minor street approaches during both peak hours. The Future plus Project operating conditions are summarized in Table 8.

Table 8 – Future and Future plus Project Peak Hour Intersection Levels of Service

Study Intersection <i>Approach</i>	Future Conditions				Future plus Project			
	Weekday PM Peak		Weekend PM Peak		Weekday PM Peak		Weekend PM Peak	
	Delay	LOS	Delay	LOS	Delay	LOS	Delay	LOS
1. North Ave/First Ave	2.9	A	3.4	A	3.1	A	3.6	A
<i>Westbound (North Ave) Approach</i>	<i>9.1</i>	<i>A</i>	<i>9.0</i>	<i>A</i>	<i>9.1</i>	<i>A</i>	<i>9.0</i>	<i>A</i>
2. North Ave/Second Ave	3.4	A	4.0	A	4.2	A	5.3	A
<i>Northbound (Second Ave) Approach</i>	<i>9.1</i>	<i>A</i>	<i>9.0</i>	<i>A</i>	<i>9.2</i>	<i>A</i>	<i>9.3</i>	<i>A</i>
<i>Southbound (Second Ave) Approach</i>	<i>9.1</i>	<i>A</i>	<i>9.0</i>	<i>A</i>	<i>9.2</i>	<i>A</i>	<i>9.1</i>	<i>A</i>
3. Coombsville Rd/First Ave	3.3	A	3.0	A	3.3	A	2.9	A
<i>Southbound (First Ave) Approach</i>	<i>10.7</i>	<i>B</i>	<i>9.6</i>	<i>A</i>	<i>10.7</i>	<i>B</i>	<i>9.7</i>	<i>A</i>
4. Coombsville Rd/Second Ave	1.4	A	1.3	A	1.6	A	1.7	A
<i>Southbound (Second Ave) Approach</i>	<i>9.3</i>	<i>A</i>	<i>9.1</i>	<i>A</i>	<i>9.4</i>	<i>A</i>	<i>9.1</i>	<i>A</i>

Notes: Delay is measured in average seconds per vehicle; LOS = Level of Service; Results for minor approaches to two-way stop-controlled intersections are indicated in *italics*

Finding – The study intersections are expected to continue operating acceptably with project traffic added to Future volumes, at the same Levels of Service as without it.

Travel Demand Analysis

Senate Bill (SB) 743 established a change in the metric to be applied to determining traffic impacts associated with development projects. Rather than the delay-based criteria associated with a Level of Service analysis, the increase in vehicle-miles-travelled (VMT) as a result of a project will be the basis for determining impacts once this new metric is fully vetted and adopted. While the County has not yet adopted a policy regarding vehicle miles traveled (VMT), the project’s contribution was estimated for informational purposes only. Vehicle miles traveled associated with the project were calculated by multiplying the estimated number of employee trips and the average home-to-work trip distance for the Traffic Analysis Zone (TAZ) in which the project is located. Using the daily trips generated for the proposed nine full-time and two part-time employees as determined using the County’s winery trip generation form, and an average distance of 12.27 miles traveled per daily trip in the project’s location as available from the Caltrans Statewide Travel Demand Model, the estimated VMT for the project is 380 vehicle miles traveled. These results are shown in Table 9.

Land Use	Daily Employee Trips	Average Trip Length	Calculated Daily VMT
Winery	31	12.27 mi	380

Again, as VMT thresholds have not yet been established by the County of Napa there is no standard against which to measure the significance of this information.

Vehicle Trip Reduction

The site is located east of the City of Napa center in an area that contains numerous other wineries and tasting rooms, so the project is likely to attract a substantial amount of linked traffic from guests visiting multiple tasting rooms in the area rather than generating new trips associated with the project itself. As is typical with existing wineries in the area, visitors in large groups often arrange for their own private van or shuttle transportation, resulting in fewer trips to and from the site than might otherwise occur. This is a transportation demand measure that is a common means of transportation as most visitors intend to drink wine, which can impair driving abilities. While it is not recommended that the project site require the use of shuttles for large groups, it is recommended that when a large group makes a reservation, they should be encouraged to use private vans or a shuttle.

The project should also promote carpooling of employees by adjusting work schedules. The County has adopted several measures in the General Plan to reduce vehicle trips through Transportation Demand Management (TDM) strategies: “The project should support programs to reduce single occupant vehicle use and encourage alternative travel modes.” The winery has the ability to reduce the dependence on single vehicle occupancy trips to reduce peak hour trips. Additionally, the project could provide lunch on-site to reduce off-site lunch related trips. It should be noted that the Napa Valley Transportation Authority (NVTA) provides a Guaranteed Ride Home (GRH) program available to persons who work in Napa County and can be used four times per year.

Recommendation – It is recommended that when reservations are made for a group, staff encourage the guests to carpool or use a shuttle or van. Additionally, it is recommended that the winery implement a TDM plan that may reduce peak-hour vehicle trips by promoting employee carpooling and potentially providing lunch on-site.

Access and Circulation

Site Access

Shadybrook Estate Winery and the Rapp Equestrian Center would continue to be accessed via the existing Rapp Lane, which is a gated private road located at the north end of Second Avenue. It is noted that the Rapp Lane approach to the intersection with Second Avenue and Chateau Lane includes a stop sign for vehicles exiting the site. Chateau Lane is another private road, which provides access to three existing single family residences.

Sight Distance

The recommended sight distance at intersections of public streets is based on corner sight distances, while recommended sight distances for minor street approaches that are either a private road or a driveway are based on stopping sight distance. Both use the approach travel speeds as the basis for determining the recommended sight distance. Additionally, the stopping sight distance needed for a following driver to stop if there is a vehicle waiting to turn into a side street or driveway is evaluated based on stopping sight distance criterion and the approach speed on the major street.

Given that the project access roadway is located at the tee-intersection with another private roadway approach (Chateau Lane) and operates as an extension of the public roadway approach (Second Avenue) and because vehicles would access the project site by making through movements from Second Avenue onto Rapp Lane, there would not be any project-related turning movements at the intersection. Additionally, because the Rapp Lane approach is stop-controlled, northbound vehicles on Second Avenue are not expected to stop and wait to turn left onto Chateau Lane. Therefore, sight distances at the project access roadway were not evaluated and neither was sight distance for following vehicles on Second Avenue.

It is noted that staff requested the evaluation of sight distance for the southbound Second Avenue approach at North Avenue. Given that the project is located at the north end of Second Avenue and does not have frontage at the intersection, the project would not have the ability to construct improvements at the intersection even if sight lines were found to be inadequate. For this reason, and as discussed with staff, sight distances at the public intersection of North Avenue/Second Avenue were not evaluated.

Access Analysis

Left-Turn Lane Warrants

Given that access to the Shadybrook Estate Winery and Rapp Equestrian Center would occur via Rapp Lane and would include northbound and southbound through movements to enter and exit the site at the intersection with Second Avenue and Chateau Lane, project trips are not anticipated to make left-turns into the site; therefore, a left-turn lane analysis on Second Avenue is not warranted.

Conclusions and Recommendations

Conclusions

- The proposed change in production, visitation, and staffing at the winery would be expected to result in an average of 46 net new daily trips on weekdays, including 17 trips during the weekday p.m. peak hour, and 44 new trips on a Saturday, including 25 trips during the peak hour.
- The Rapp Equestrian Center currently generates and would continue to generate an average of 64 daily trips on weekdays and weekend days, with 24 trips during the weekday p.m. peak hour and 36 trips during the weekend peak hour.
- Under Existing conditions, the study intersections operate acceptably at LOS A overall and LOS A or B on the minor approaches during both peak periods and they would be expected to continue operating at these service levels with the addition of project-generated traffic.
- Under anticipated Future volumes, the study intersections are expected to continue operating acceptably at LOS A or B overall and on the stop-controlled minor street approaches during both peak hours both without and with the addition of project-related trips.
- Sight distances from and to the project driveway along Rapp Lane and Second Avenue are adequate.
- A left-turn lane is not warranted on Second Avenue for project-generated traffic.

Recommendations

- It is recommended that when groups call to make a reservation for a tasting or tour, staff should encourage the guests to carpool or use a shuttle or van.
- The applicant should establish a TDM plan to reduce peak hour trips. Trip reduction measures could include promoting employee carpooling and potentially providing lunch on-site for employees.

Study Participants and References

Study Participants

Principal in Charge	Dalene J. Whitlock, PE, PTOE
Assistant Engineer	Kevin Rangel, EIT
Graphics	Katia Wolfe
Editing/Formatting	Alex Scrobonia
Quality Control	Dalene J. Whitlock, PE, PTOE

References

2014 Collision Data on California State Highways, California Department of Transportation, 2017
Guidelines for Interpretation of General Plan Circulation Policies on Significance Criteria, Fehr & Peers, 2015
Highway Capacity Manual, Transportation Research Board, 2018
Highway Design Manual, 6th Edition, California Department of Transportation, 2018
Napa County Bicycle Plan, W-Trans, 2012
Napa County Code, Municipal Code Corporation, 2017
Napa County General Plan, County of Napa, 2013
Napa County Road and Street Standards, County of Napa, 2016
Statewide Integrated Traffic Records System (SWITRS), California Highway Patrol, 2014-2019
Trip Generation Manual, 10th Edition, Institute of Transportation Engineers, 2017

Communications

Kazmi, Ahsan. "RE: Rapp Equestrian Center P18-00197-UP." Message to PBES Staff. January 16, 2019. Memorandum.

Kazmi, Ahsan. "RE: Shadybrook Winery (P18-00450) Memo of Assumptions for Traffic Study." Message to PBES Staff. June 19, 2019. Memorandum.

Whitlock, Dalene. "RE: Rapp Traffic Comments." Message to Ahsan Kazmi. March 11, 2019. Email.

NAX149



Appendix A

Collision Records and Collision Rate Calculations



This page intentionally left blank

NAX149 Intersection Collisions

Collision Report Summary

8/9/2019

Date Range Reported: 4/1/14 - 3/31/19

Total Number of Collisions: 2

Total Number of Persons Injured: 1

Total Number of Persons Killed: 0

Page 1

Report#	Date	Time	Location	Dist.	Dir.	Type of Collision	Motor Veh. Involved With	Dir. of Travel 1	Movement Prec. Coll. 1	Dir. of Travel 2	Movement Prec. Coll. 2	PCF	Inj.	Kil.
90023247	9/18/15	15:40	1st Avenue & North Avenue	1056'	North	Hit Object	Fixed Object	North	Ran Off Road			Driving Under Influence	1	0
90657031	2/3/18	08:40	First Avenue & North Avenue	20'	South	Hit Object	Fixed Object	West	Proceeding Straight			Unsafe Speed	0	0

NAX149 Intersection Collisions

Collision Report Summary

8/9/2019

Date Range Reported: 4/1/14 - 3/31/19

Total Number of Collisions: 2

Total Number of Persons Injured: 0

Total Number of Persons Killed: 0

Page 1

Report#	Date	Time	Location	Dist.	Dir.	Type of Collision	Motor Veh. Involved With	Dir. of Travel 1	Movement Prec. Coll. 1	Dir. of Travel 2	Movement Prec. Coll. 2	PCF	Inj.	Kil.
6941015	6/25/15	15:00	North Av & 2nd Av	0'	In Int.	Broadside	Other Motor Vehicle	North	Proceeding Straight	West	Proceeding Straight	Auto R/W Violation	0	0
90688775	3/14/18	13:20	North Avenue & 2nd Ave	0'	In Int.	Broadside	Other Motor Vehicle	North	Making Left Turn	East	Proceeding Straight	Auto R/W Violation	0	0

NAX149 Intersection Collisions

Collision Report Summary

8/9/2019

Date Range Reported: 4/1/14 - 3/31/19

Total Number of Collisions: 5

Total Number of Persons Injured: 4

Total Number of Persons Killed: 0

Page 1

Report#	Date	Time	Location	Dist.	Dir.	Type of Collision	Motor Veh. Involved With	Dir. of Travel 1	Movement Prec. Coll. 1	Dir. of Travel 2	Movement Prec. Coll. 2	PCF	Inj.	Kil.
90033316	10/7/15	00:33	Coombsville Rd & First Avenue	335'	West	Hit Object	Fixed Object	East	Other Unsafe Turning			Improper Turning	1	0
90092964	12/24/15	00:15	Coombsville Rd & First Ave	1267'	West	Overturned	Non-Collision	East	Other Unsafe Turning			Driving Under Influence	3	0
90310549	10/25/16	00:50	Coombsville Road & First Avenue	1025'	West	Overturned	Non-Collision	West	Ran Off Road			Driving Under Influence	0	0
90395031	2/13/17	21:35	Coombsville Rd & 1st Ave	0'	In Int.	Hit Object	Fixed Object	West	Proceeding Straight			Unsafe Speed	0	0
90666983	2/18/18	02:45	Coombsville Rd & First Ave	100'	West	Hit Object	Fixed Object	East	Ran Off Road			Improper Turning	0	0

NAX149 Intersection Collisions

Collision Report Summary

8/9/2019

Date Range Reported: 4/1/14 - 3/31/19

Total Number of Collisions: 2

Total Number of Persons Injured: 0

Total Number of Persons Killed: 0

Page 1

Report#	Date	Time	Location	Dist.	Dir.	Type of Collision	Motor Veh. Involved With	Dir. of Travel 1	Movement Prec. Coll. 1	Dir. of Travel 2	Movement Prec. Coll. 2	PCF	Inj.	Kil.
6530049	6/19/14	16:20	2nd Av & Coombsville Rd	320'	North	Hit Object	Fixed Object	North	Ran Off Road	Not Stat	Parked	Improper Turning	0	0
90217443	7/4/16	17:35	Coombsville Rd E/B & Second Ave	730'	West	Hit Object	Fixed Object	East	Ran Off Road			Improper Turning	0	0

NAX149 Segment Collisions

Collision Report Summary

8/23/2019

Date Range Reported: 4/1/14 - 3/31/19

Total Number of Collisions: 1

Total Number of Persons Injured: 0

Total Number of Persons Killed: 0

Page 1

Report#	Date	Time	Location	Dist.	Dir.	Type of Collision	Motor Veh. Involved With	Dir. of Travel 1	Movement Prec. Coll. 1	Dir. of Travel 2	Movement Prec. Coll. 2	PCF	Inj.	Kil.
90688775	3/14/18	13:20	North Avenue & 2nd Ave	0'	In Int.	Broadside	Other Motor Vehicle	North	Making Left Turn	East	Proceeding Straight	Auto R/W Violation	0	0

Intersection Collision Rate Calculations

TIS for the Shadybrook Estate Winery and Rapp Equestrian Center

Intersection # 1: First Avenue & North Avenue

Date of Count: Friday, July 12, 2019

Number of Collisions: 1

Number of Injuries: 0

Number of Fatalities: 0

ADT: 2300

Start Date: April 1, 2014

End Date: March 31, 2019

Number of Years: 5

Intersection Type: Tee

Control Type: Stop & Yield Controls

Area: Rural

$$\text{collision rate} = \frac{\text{Number of Collisions} \times 1 \text{ Million}}{\text{ADT} \times 365 \text{ Days per Year} \times \text{Number of Years}}$$

$$\text{collision rate} = \frac{1}{2,300} \times \frac{1,000,000}{365 \times 5}$$

	Collision Rate	Fatality Rate	Injury Rate
Study Intersection	0.24 c/mve	0.0%	0.0%
Statewide Average*	0.16 c/mve	1.7%	39.2%

ADT = average daily total vehicles entering intersection

c/mve = collisions per million vehicles entering intersection

* 2013 Collision Data on California State Highways, Caltrans

Intersection # 2: North Avenue & Second Avenue

Date of Count: Friday, July 12, 2019

Number of Collisions: 2

Number of Injuries: 0

Number of Fatalities: 0

ADT: 1000

Start Date: April 1, 2014

End Date: March 31, 2019

Number of Years: 5

Intersection Type: Four-Legged

Control Type: Stop & Yield Controls

Area: Rural

$$\text{collision rate} = \frac{\text{Number of Collisions} \times 1 \text{ Million}}{\text{ADT} \times 365 \text{ Days per Year} \times \text{Number of Years}}$$

$$\text{collision rate} = \frac{2}{1,000} \times \frac{1,000,000}{365 \times 5}$$

	Collision Rate	Fatality Rate	Injury Rate
Study Intersection	1.10 c/mve	0.0%	0.0%
Statewide Average*	0.23 c/mve	2.0%	40.4%

ADT = average daily total vehicles entering intersection

c/mve = collisions per million vehicles entering intersection

* 2013 Collision Data on California State Highways, Caltrans

Intersection Collision Rate Calculations

TIS for the Shadybrook Estate Winery and Rapp Equestrian Center

Intersection # 3: Coombsville Road & First Avenue

Date of Count: Friday, July 12, 2019

Number of Collisions: 2

Number of Injuries: 0

Number of Fatalities: 0

ADT: 4200

Start Date: April 1, 2014

End Date: March 31, 2019

Number of Years: 5

Intersection Type: Tee

Control Type: Stop & Yield Controls

Area: Rural

$$\text{collision rate} = \frac{\text{Number of Collisions} \times 1 \text{ Million}}{\text{ADT} \times 365 \text{ Days per Year} \times \text{Number of Years}}$$

$$\text{collision rate} = \frac{2}{4,200} \times \frac{1,000,000}{365 \times 5}$$

	Collision Rate	Fatality Rate	Injury Rate
Study Intersection	0.26 c/mve	0.0%	0.0%
Statewide Average*	0.16 c/mve	1.7%	39.2%

ADT = average daily total vehicles entering intersection
 c/mve = collisions per million vehicles entering intersection
 * 2013 Collision Data on California State Highways, Caltrans

Intersection # 4: Coombsville Road & Second Avenue

Date of Count: Friday, July 12, 2019

Number of Collisions: 0

Number of Injuries: 0

Number of Fatalities: 0

ADT: 2900

Start Date: April 1, 2014

End Date: March 31, 2019

Number of Years: 5

Intersection Type: Tee

Control Type: Stop & Yield Controls

Area: Rural

$$\text{collision rate} = \frac{\text{Number of Collisions} \times 1 \text{ Million}}{\text{ADT} \times 365 \text{ Days per Year} \times \text{Number of Years}}$$

$$\text{collision rate} = \frac{0}{2,900} \times \frac{1,000,000}{365 \times 5}$$

	Collision Rate	Fatality Rate	Injury Rate
Study Intersection	0.00 c/mve	0.0%	0.0%
Statewide Average*	0.16 c/mve	1.7%	39.2%

ADT = average daily total vehicles entering intersection
 c/mve = collisions per million vehicles entering intersection
 * 2013 Collision Data on California State Highways, Caltrans



This page intentionally left blank

Appendix B

Traffic Count Data





This page intentionally left blank

VOLUME

2nd Ave N/O North Ave

Day: Thursday
Date: 3/14/2019

City: Napa
Project #: CA19_8141_001

DAILY TOTALS					NB	SB	EB	WB	Total		
					185	185	0	0	370		
AM Period	NB	SB	EB	WB	TOTAL	PM Period	NB	SB	EB	WB	TOTAL
00:00	0	0			0	12:00	3	3			6
00:15	0	0			0	12:15	1	4			5
00:30	0	0			0	12:30	7	4			11
00:45	0	0			0	12:45	3	14	1	12	26
01:00	0	0			0	13:00	4	5			9
01:15	0	0			0	13:15	3	2			5
01:30	0	0			0	13:30	3	4			7
01:45	0	0			0	13:45	2	12	4	15	27
02:00	2	1			3	14:00	3	4			7
02:15	0	1			1	14:15	3	3			6
02:30	2	3			5	14:30	1	3			4
02:45	0	4	0	5	0	14:45	4	11	7	17	28
03:00	0	0			0	15:00	1	2			3
03:15	0	0			0	15:15	10	1			11
03:30	0	0			0	15:30	2	9			11
03:45	1	1	2	2	3	15:45	2	15	3	15	30
04:00	0	0			0	16:00	1	4			5
04:15	1	0			1	16:15	0	1			1
04:30	0	1			1	16:30	8	9			17
04:45	0	1	1	2	1	16:45	1	10	6	20	30
05:00	0	0			0	17:00	3	4			7
05:15	0	0			0	17:15	2	2			4
05:30	1	2			3	17:30	2	2			4
05:45	0	1	0	2	0	17:45	2	9	4	12	21
06:00	0	0			0	18:00	4	2			6
06:15	1	1			2	18:15	2	2			4
06:30	3	1			4	18:30	1	2			3
06:45	7	11	1	3	8	18:45	0	7	3	9	16
07:00	7	0			7	19:00	0	2			2
07:15	0	2			2	19:15	0	1			1
07:30	1	7			8	19:30	4	2			6
07:45	7	15	1	10	8	19:45	0	4	3	8	12
08:00	5	1			6	20:00	2	0			2
08:15	5	2			7	20:15	3	1			4
08:30	4	1			5	20:30	1	2			3
08:45	5	19	2	6	7	20:45	1	7	0	3	10
09:00	6	3			9	21:00	0	0			0
09:15	4	4			8	21:15	0	0			0
09:30	3	3			6	21:30	0	0			0
09:45	5	18	2	12	7	21:45	0	0			0
10:00	3	9			12	22:00	2	0			2
10:15	5	5			10	22:15	0	2			2
10:30	3	4			7	22:30	0	0			0
10:45	2	13	2	20	4	22:45	0	2	0	2	4
11:00	2	2			4	23:00	0	0			0
11:15	3	3			6	23:15	0	0			0
11:30	3	3			6	23:30	0	0			0
11:45	3	11	2	10	5	23:45	0	0			0
TOTALS	94	72			166	TOTALS	91	113			204
SPLIT %	56.6%	43.4%			44.9%	SPLIT %	44.6%	55.4%			55.1%

DAILY TOTALS					NB	SB	EB	WB	Total		
					185	185	0	0	370		
AM Peak Hour	07:45	09:45		09:45	PM Peak Hour	12:30	16:30		14:45		
AM Pk Volume	21	20		36	PM Pk Volume	17	21		36		
Pk Hr Factor	0.750	0.556		0.750	Pk Hr Factor	0.607	0.583		0.818		
7 - 9 Volume	34	16	0	0	50	4 - 6 Volume	19	32	0	0	51
7 - 9 Peak Hour	07:45	07:15		07:30	4 - 6 Peak Hour	16:30	16:30				16:30
7 - 9 Pk Volume	21	11	0	0	29	4 - 6 Pk Volume	14	21	0	0	35
Pk Hr Factor	0.750	0.393	0.000	0.000	0.906	Pk Hr Factor	0.438	0.583	0.000	0.000	0.515

VOLUME

2nd Ave N/O North Ave

Day: Friday
Date: 3/15/2019

City: Napa
Project #: CA19_8141_001

DAILY TOTALS					NB	SB	EB	WB	Total		
					171	177	0	0	348		
AM Period	NB	SB	EB	WB	TOTAL	PM Period	NB	SB	EB	WB	TOTAL
00:00	0	0			0	12:00	4	3			7
00:15	0	0			0	12:15	2	8			10
00:30	0	0			0	12:30	5	5			10
00:45	0	0			0	12:45	4	15	5	21	36
01:00	0	0			0	13:00	3	2			5
01:15	0	0			0	13:15	3	5			8
01:30	0	0			0	13:30	1	1			2
01:45	0	0			0	13:45	3	10	4	12	22
02:00	0	0			0	14:00	4	4			8
02:15	1	1			2	14:15	5	2			7
02:30	0	0			0	14:30	6	4			10
02:45	0	1	0	1	0	14:45	2	17	5	15	32
03:00	0	1			1	15:00	2	1			3
03:15	0	0			0	15:15	2	7			9
03:30	0	0			0	15:30	4	5			9
03:45	1	1	1	2	2	15:45	5	13	4	17	30
04:00	0	0			0	16:00	2	4			6
04:15	0	1			1	16:15	1	5			6
04:30	0	0			0	16:30	2	2			4
04:45	0	0	1		0	16:45	3	8	5	16	24
05:00	0	1			1	17:00	3	8			11
05:15	0	0			0	17:15	0	4			4
05:30	1	0			1	17:30	4	1			5
05:45	0	1	0	1	0	17:45	1	8	3	16	24
06:00	1	0			1	18:00	2	4			6
06:15	0	1			1	18:15	1	4			5
06:30	2	1			3	18:30	1	2			3
06:45	3	6	0	2	3	18:45	0	4	1	11	15
07:00	5	2			7	19:00	0	2			2
07:15	2	0			2	19:15	0	0			0
07:30	2	1			3	19:30	2	0			2
07:45	5	14	3	6	8	19:45	0	2	3	5	7
08:00	5	1			6	20:00	1	1			2
08:15	5	3			8	20:15	1	0			1
08:30	3	2			5	20:30	2	1			3
08:45	6	19	1	7	7	20:45	1	5	1	3	8
09:00	3	2			5	21:00	0	0			0
09:15	3	0			3	21:15	0	0			0
09:30	6	3			9	21:30	0	0			0
09:45	5	17	5	10	10	21:45	0	0			0
10:00	3	2			5	22:00	0	0			0
10:15	3	5			8	22:15	0	0			0
10:30	2	4			6	22:30	0	0			0
10:45	4	12	9	20	13	22:45	0	0			0
11:00	3	2			5	23:00	0	0			0
11:15	5	2			7	23:15	0	0			0
11:30	7	4			11	23:30	0	0			0
11:45	2	17	3	11	5	23:45	1	1	0		1
TOTALS	88	61			149	TOTALS	83	116			199
SPLIT %	59.1%	40.9%			42.8%	SPLIT %	41.7%	58.3%			57.2%

DAILY TOTALS					NB	SB	EB	WB	Total	
					171	177	0	0	348	
AM Peak Hour	08:00	10:00		10:45	PM Peak Hour	13:45	12:00		12:00	
AM Pk Volume	19	20		36	PM Pk Volume	18	21		36	
Pk Hr Factor	0.792	0.556		0.692	Pk Hr Factor	0.750	0.656		0.900	
7 - 9 Volume	33	13	0	0	4 - 6 Volume	16	32	0	0	48
7 - 9 Peak Hour	08:00	07:45		07:45	4 - 6 Peak Hour	16:45	16:15			16:15
7 - 9 Pk Volume	19	9	0	0	4 - 6 Pk Volume	10	20	0	0	29
Pk Hr Factor	0.792	0.750	0.000	0.000	Pk Hr Factor	0.625	0.625	0.000	0.000	0.659

VOLUME

2nd Ave N/O North Ave

Day: Saturday
Date: 3/16/2019

City: Napa
Project #: CA19_8141_001

DAILY TOTALS					NB	SB	EB	WB	Total		
					147	151	0	0	298		
AM Period	NB	SB	EB	WB	TOTAL	PM Period	NB	SB	EB	WB	TOTAL
00:00	0	0			0	12:00	2	5			7
00:15	0	0			0	12:15	1	3			4
00:30	0	0			0	12:30	7	2			9
00:45	0	0			0	12:45	3	13	3	13	26
01:00	0	0			0	13:00	10	2			12
01:15	0	0			0	13:15	3	6			9
01:30	0	0			0	13:30	2	1			3
01:45	0	0			0	13:45	5	20	5	14	34
02:00	0	0			0	14:00	2	4			6
02:15	0	0			0	14:15	4	2			6
02:30	0	0			0	14:30	4	1			5
02:45	0	0			0	14:45	3	13	8	15	28
03:00	0	0			0	15:00	2	2			4
03:15	0	0			0	15:15	2	4			6
03:30	0	1			1	15:30	4	4			8
03:45	1	1	2		2	15:45	2	10	4	14	24
04:00	0	0			0	16:00	0	3			3
04:15	0	0			0	16:15	2	1			3
04:30	0	0			0	16:30	5	6			11
04:45	0	0			0	16:45	2	9	7	17	26
05:00	0	0			0	17:00	4	4			8
05:15	0	0			0	17:15	0	3			3
05:30	0	0			0	17:30	2	2			4
05:45	1	1	0		1	17:45	0	6	1	10	16
06:00	0	0			0	18:00	2	8			10
06:15	0	0			0	18:15	0	3			3
06:30	1	0			1	18:30	1	1			2
06:45	3	4	0		3	18:45	0	3	0	12	15
07:00	1	0			1	19:00	3	0			3
07:15	0	0			0	19:15	1	2			3
07:30	2	0			2	19:30	0	1			1
07:45	3	6	0		3	19:45	1	5	1	4	9
08:00	3	2			5	20:00	1	2			3
08:15	0	0			0	20:15	0	0			0
08:30	0	4			4	20:30	1	0			1
08:45	2	5	1	7	3	20:45	0	2	0	2	4
09:00	6	3			9	21:00	1	0			1
09:15	3	4			7	21:15	0	1			1
09:30	2	4			6	21:30	0	0			0
09:45	1	12	2	13	3	21:45	0	1	0	1	2
10:00	4	1			5	22:00	0	0			0
10:15	4	2			6	22:15	0	2			2
10:30	5	1			6	22:30	0	0			0
10:45	1	14	7	11	8	22:45	0	0	2		2
11:00	8	4			12	23:00	1	0			1
11:15	5	4			9	23:15	0	0			0
11:30	1	2			3	23:30	0	0			0
11:45	7	21	4	14	11	23:45	0	1	0		1
TOTALS	64	47			111	TOTALS	83	104			187
SPLIT %	57.7%	42.3%			37.2%	SPLIT %	44.4%	55.6%			62.8%

DAILY TOTALS					NB	SB	EB	WB	Total
					147	151	0	0	298

AM Peak Hour	11:00	10:45			10:30	PM Peak Hour	12:30	16:30			12:30
AM Pk Volume	21	17			35	PM Pk Volume	23	20			36
Pk Hr Factor	0.656	0.607			0.729	Pk Hr Factor	0.575	0.714			0.750
7 - 9 Volume	11	7	0	0	18	4 - 6 Volume	15	27	0	0	42
7 - 9 Peak Hour	07:15	08:00			07:45	4 - 6 Peak Hour	16:15	16:30			16:15
7 - 9 Pk Volume	8	7	0	0	12	4 - 6 Pk Volume	13	20	0	0	31
Pk Hr Factor	0.667	0.438	0.000	0.000	0.600	Pk Hr Factor	0.650	0.714	0.000	0.000	0.705

VOLUME

2nd Ave N/O North Ave

Day: Sunday
Date: 3/17/2019

City: Napa
Project #: CA19_8141_001

DAILY TOTALS					NB	SB	EB	WB	Total		
					117	114	0	0	231		
AM Period	NB	SB	EB	WB	TOTAL	PM Period	NB	SB	EB	WB	TOTAL
00:00	0	0			0	12:00	4	6			10
00:15	0	0			0	12:15	1	3			4
00:30	0	0			0	12:30	5	3			8
00:45	0	1	1		1	12:45	4	14	0	12	26
01:00	0	0			0	13:00	6	0			6
01:15	0	0			0	13:15	2	3			5
01:30	0	0			0	13:30	0	2			2
01:45	0	0			0	13:45	3	11	4	9	20
02:00	0	0			0	14:00	3	0			3
02:15	0	0			0	14:15	2	2			4
02:30	0	0			0	14:30	2	3			5
02:45	0	0			0	14:45	0	7	4	9	16
03:00	0	0			0	15:00	3	8			11
03:15	0	0			0	15:15	8	5			13
03:30	0	0			0	15:30	3	4			7
03:45	1	1	1	1	2	15:45	3	17	3	20	37
04:00	1	1			2	16:00	1	3			4
04:15	0	0			0	16:15	2	1			3
04:30	0	0			0	16:30	3	3			6
04:45	0	1	0	1	0	16:45	2	8	4	11	19
05:00	0	0			0	17:00	2	1			3
05:15	0	1			1	17:15	1	3			4
05:30	0	0			0	17:30	2	0			2
05:45	0	0	1		0	17:45	4	9	0	4	13
06:00	0	0			0	18:00	2	3			5
06:15	0	0			0	18:15	2	0			2
06:30	1	0			1	18:30	2	4			6
06:45	0	1	0		0	18:45	0	6	1	8	14
07:00	1	2			3	19:00	3	5			8
07:15	1	0			1	19:15	0	2			2
07:30	0	0			0	19:30	0	7			7
07:45	1	3	0	2	1	19:45	2	5	0	14	19
08:00	1	0			1	20:00	1	0			1
08:15	0	0			0	20:15	0	0			0
08:30	0	0			0	20:30	0	1			1
08:45	4	5	0		4	20:45	0	1	0	1	2
09:00	3	4			7	21:00	0	0			0
09:15	2	1			3	21:15	1	0			1
09:30	4	1			5	21:30	1	0			1
09:45	2	11	6	12	8	21:45	0	2	0		2
10:00	1	1			2	22:00	1	1			2
10:15	2	1			3	22:15	0	0			0
10:30	2	1			3	22:30	0	0			0
10:45	1	6	1	4	2	22:45	0	1	0	1	2
11:00	2	0			2	23:00	0	0			0
11:15	0	1			1	23:15	0	0			0
11:30	5	0			5	23:30	0	0			0
11:45	1	8	2	3	3	23:45	0	0			0
TOTALS	36	25			61	TOTALS	81	89			170
SPLIT %	59.0%	41.0%			26.4%	SPLIT %	47.6%	52.4%			73.6%

DAILY TOTALS					NB	SB	EB	WB	Total
					117	114	0	0	231

AM Peak Hour	08:45	11:45			11:45	PM Peak Hour	12:30	14:45			15:00
AM Pk Volume	13	14			25	PM Pk Volume	17	21			37
Pk Hr Factor	0.813	0.583			0.625	Pk Hr Factor	0.708	0.656			0.712
7 - 9 Volume	8	2	0	0	10	4 - 6 Volume	17	15	0	0	32
7 - 9 Peak Hour	08:00	07:00			07:00	4 - 6 Peak Hour	16:15	16:00			16:00
7 - 9 Pk Volume	5	2	0	0	5	4 - 6 Pk Volume	9	11	0	0	19
Pk Hr Factor	0.313	0.250	0.000	0.000	0.417	Pk Hr Factor	0.750	0.688	0.000	0.000	0.792

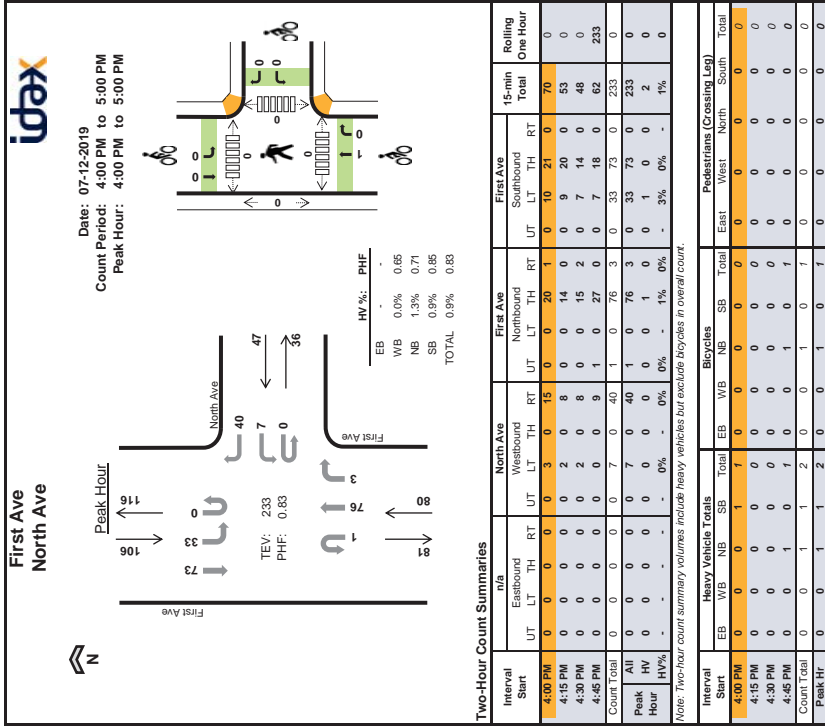

Two-Hour Count Summaries - Heavy Vehicles

Interval Start	Eastbound				North Ave Westbound				First Ave Southbound				Rolling One Hour
	UT	LT	TH	RT	UT	LT	TH	RT	UT	LT	TH	RT	
4:00 PM	0	0	0	0	0	0	0	0	0	0	0	0	0
4:15 PM	0	0	0	0	0	0	0	0	0	0	0	0	0
4:30 PM	0	0	0	0	0	0	0	0	0	0	0	0	0
4:45 PM	0	0	0	0	0	0	0	0	0	0	0	0	0
Count Total	0	0	0	0	0	0	0	0	0	0	0	0	0
Peak Hour	0	0	0	0	0	0	0	0	0	0	0	0	0

Two-Hour Count Summaries - Bikes

Interval Start	Eastbound				North Ave Westbound				First Ave Southbound				Rolling One Hour
	LT	TH	RT	UT	LT	TH	RT	UT	LT	TH	RT	UT	
4:00 PM	0	0	0	0	0	0	0	0	0	0	0	0	0
4:15 PM	0	0	0	0	0	0	0	0	0	0	0	0	0
4:30 PM	0	0	0	0	0	0	0	0	0	0	0	0	0
4:45 PM	0	0	0	0	0	0	0	0	0	0	0	0	0
Count Total	0	0	0	0	0	0	0	0	0	0	0	0	0
Peak Hour	0	0	0	0	0	0	0	0	0	0	0	0	0

Note: U-Turn volumes for bikes are included in Left-Turn, if any.

Two-Hour Count Summaries

Interval Start	Eastbound				North Ave Westbound				First Ave Southbound				Rolling One Hour			
	UT	LT	TH	RT	UT	LT	TH	RT	UT	LT	TH	RT				
4:00 PM	0	0	0	0	3	0	15	0	0	20	1	0	10	21	0	70
4:15 PM	0	0	0	0	2	0	8	0	0	14	0	0	9	20	0	53
4:30 PM	0	0	0	0	2	0	8	0	0	15	2	0	7	14	0	48
4:45 PM	0	0	0	0	0	0	9	1	0	27	0	0	7	18	0	62
Count Total	0	0	0	0	7	0	40	1	0	76	3	0	33	73	0	233
Peak Hour	0	0	0	0	7	0	40	1	0	76	3	0	33	73	0	233
HV%	0	0	0	0	0	0	0	0	0	1	0	0	0	0	0	2
HV%	-	-	-	-	-	-	0%	-	-	1%	0%	-	-	3%	0%	1%

Interval Start	Heavy Vehicle Totals			Bicycles			Pedestrians (Crossing Leg)		
	EB	WB	NB	SB	Total	East	West	South	Total
4:00 PM	0	0	0	1	1	0	0	0	0
4:15 PM	0	0	0	0	0	0	0	0	0
4:30 PM	0	0	0	0	0	0	0	0	0
4:45 PM	0	0	1	1	2	0	0	0	2
Count Total	0	0	1	1	2	0	0	0	2
Peak Hr	0	0	1	1	2	0	0	0	2

Note: Two-hour count summary volumes include heavy vehicles but exclude bicycles in overall count.

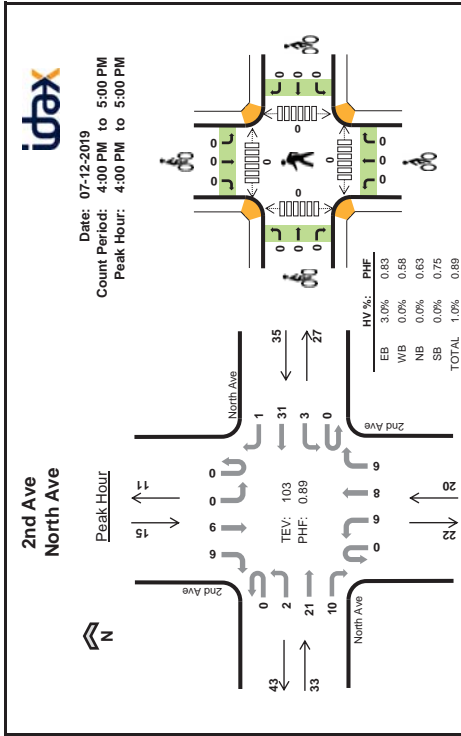

Two-Hour Count Summaries - Heavy Vehicles

Interval Start	North Ave Eastbound			North Ave Westbound			2nd Ave Northbound			2nd Ave Southbound			15-min Total	Rolling One Hour			
	UT	LT	TH	RT	LT	TH	RT	UT	LT	TH	RT	UT			LT	TH	RT
4:00 PM	0	0	0	1	0	0	0	0	0	0	0	0	0	0	0	1	0
4:15 PM	0	0	0	0	0	0	0	0	0	0	0	0	0	0	0	0	0
4:30 PM	0	0	0	0	0	0	0	0	0	0	0	0	0	0	0	0	0
4:45 PM	0	0	0	0	0	0	0	0	0	0	0	0	0	0	0	0	0
Count Total	0	0	0	1	0	0	0	0	0	0	0	0	0	0	0	1	0
Peak Hour	0	0	0	1	0	0	0	0	0	0	0	0	0	0	0	1	0

Two-Hour Count Summaries - Bikes

Interval Start	North Ave Eastbound			North Ave Westbound			2nd Ave Northbound			2nd Ave Southbound			15-min Total	Rolling One Hour			
	LT	TH	RT	LT	TH	RT	LT	TH	RT	LT	TH	RT					
4:00 PM	0	0	0	0	0	0	0	0	0	0	0	0	0	0	0	0	0
4:15 PM	0	0	0	0	0	0	0	0	0	0	0	0	0	0	0	0	0
4:30 PM	0	0	0	0	0	0	0	0	0	0	0	0	0	0	0	0	0
4:45 PM	0	0	0	0	0	0	0	0	0	0	0	0	0	0	0	0	0
Count Total	0	0	0	0	0	0	0	0	0	0	0	0	0	0	0	0	0
Peak Hour	0	0	0	0	0	0	0	0	0	0	0	0	0	0	0	0	0

Note: LT-Turn volumes for bikes are included in Left-Turn, if any.

Two-Hour Count Summaries

Interval Start	North Ave Eastbound			North Ave Westbound			2nd Ave Northbound			2nd Ave Southbound			15-min Total	Rolling One Hour			
	UT	LT	TH	RT	LT	TH	RT	UT	LT	TH	RT						
4:00 PM	0	1	5	4	0	1	14	0	0	1	0	0	0	2	29	0	
4:15 PM	0	1	6	1	0	2	6	0	0	4	1	1	0	0	3	26	0
4:30 PM	0	0	6	1	0	3	0	0	1	5	2	0	0	4	1	23	0
4:45 PM	0	0	4	4	0	0	8	1	0	0	2	2	0	0	2	25	103
Count Total	0	2	21	10	0	3	31	1	0	6	8	6	0	0	9	6	103
Peak Hour	0	2	21	10	0	3	31	1	0	6	8	6	0	0	9	6	103
HV	0	0	0	1	0	0	0	0	0	0	0	0	0	0	0	0	1
HV%	-	0%	0%	10%	-	0%	0%	0%	-	0%	0%	0%	-	-	0%	0%	1%

Heavy Vehicle Totals

Interval Start	EB	WB	NB	SB	Total
4:00 PM	1	0	0	0	1
4:15 PM	0	0	0	0	0
4:30 PM	0	0	0	0	0
4:45 PM	1	0	0	0	1
Count Total	1	0	0	0	1
Peak Hour	1	0	0	0	1

Bicycles

Interval Start	EB	WB	NB	SB	Total
4:00 PM	0	0	0	0	0
4:15 PM	0	0	0	0	0
4:30 PM	0	0	0	0	0
4:45 PM	0	0	0	0	0
Count Total	0	0	0	0	0
Peak Hour	0	0	0	0	0

Pedestrians (Crossing Leg)

Interval Start	East	West	North	South	Total
4:00 PM	0	0	0	0	0
4:15 PM	0	0	0	0	0
4:30 PM	0	0	0	0	0
4:45 PM	0	0	0	0	0
Count Total	0	0	0	0	0
Peak Hour	0	0	0	0	0

Note: Two-hour count summary volumes include heavy vehicles but exclude bicycles in overall count.

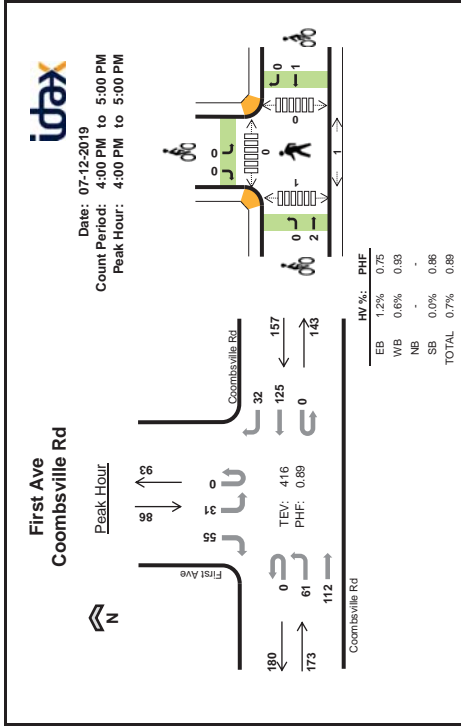

Two-Hour Count Summaries - Heavy Vehicles

Interval Start	Coombsville Rd Eastbound				Coombsville Rd Westbound				n/a Northbound				n/a Southbound				Rolling One Hour
	UT	LT	TH	RT	UT	LT	TH	RT	UT	LT	TH	RT	UT	LT	TH	RT	
4:00 PM	0	0	0	0	0	0	0	0	0	0	0	0	0	0	0	0	0
4:15 PM	0	0	0	0	0	0	0	0	0	0	0	0	0	0	0	0	0
4:30 PM	0	1	1	0	0	0	0	0	0	0	0	0	0	0	0	0	0
4:45 PM	0	0	0	0	0	0	0	0	0	0	0	0	0	0	0	0	0
Count Total	0	1	1	0	0	0	0	0	0	0	0	0	0	0	0	0	0
Peak Hour	0	1	1	0	0	0	0	0	0	0	0	0	0	0	0	0	0

Two-Hour Count Summaries - Bikes

Interval Start	Coombsville Rd Eastbound				Coombsville Rd Westbound				n/a Northbound				n/a Southbound				Rolling One Hour
	UT	LT	TH	RT	UT	LT	TH	RT	UT	LT	TH	RT	UT	LT	TH	RT	
4:00 PM	0	2	0	0	0	0	0	0	0	0	0	0	0	0	0	0	0
4:15 PM	0	0	0	0	0	0	0	0	0	0	0	0	0	0	0	0	0
4:30 PM	0	0	0	0	0	0	0	0	0	0	0	0	0	0	0	0	0
4:45 PM	0	0	0	0	0	0	0	0	0	0	0	0	0	0	0	0	0
Count Total	0	2	0	0	0	0	0	0	0	0	0	0	0	0	0	0	0
Peak Hour	0	2	0	0	0	0	0	0	0	0	0	0	0	0	0	0	0

Note: U-Turn volumes for bikes are included in Left-Turn, if any.

Two-Hour Count Summaries

Interval Start	Coombsville Rd Eastbound				Coombsville Rd Westbound				n/a Northbound				n/a Southbound				Rolling One Hour
	UT	LT	TH	RT	UT	LT	TH	RT	UT	LT	TH	RT	UT	LT	TH	RT	
4:00 PM	0	16	22	0	0	0	30	7	0	0	0	0	0	8	0	17	100
4:15 PM	0	9	29	0	0	0	31	8	0	0	0	0	0	7	0	15	99
4:30 PM	0	13	26	0	0	0	33	9	0	0	0	0	0	5	0	14	100
4:45 PM	0	23	35	0	0	0	31	8	0	0	0	0	0	11	0	9	117
Count Total	0	61	112	0	0	0	125	32	0	0	0	0	0	31	0	55	416
Peak Hour	0	61	112	0	0	0	125	32	0	0	0	0	0	31	0	55	416
Peak HV	0	1	1	0	0	0	1	0	0	0	0	0	0	0	0	0	3
Peak HV%	-	2%	1%	-	-	-	1%	0%	-	-	-	-	-	0%	-	0%	1%

Interval Start	Heavy Vehicle Totals				Bicycles				Pedestrians (Crossing Leg)					
	EB	WB	NB	SB	Total	EB	WB	SB	Total	East	West	North	South	Total
4:00 PM	0	1	0	0	1	2	0	0	2	0	0	0	0	0
4:15 PM	0	0	0	0	0	1	0	0	1	0	0	0	0	1
4:30 PM	2	0	0	0	2	0	0	0	0	0	0	0	0	0
4:45 PM	0	0	0	0	0	0	0	0	0	1	0	0	0	1
Count Total	2	1	0	0	3	2	1	0	3	0	1	0	0	1
Peak Hr	2	1	0	0	3	2	1	0	3	0	1	0	0	1

Note: Two-hour count summary volumes include heavy vehicles but exclude bicycles in overall count.

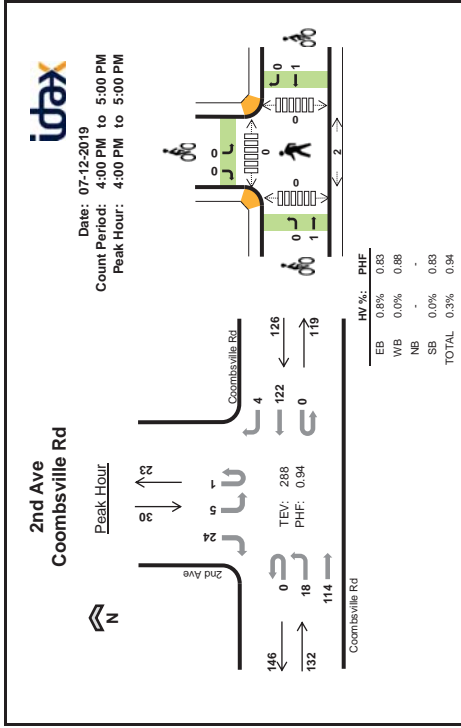

Two-Hour Count Summaries - Heavy Vehicles

Interval Start	Coombsville Rd Eastbound				Coombsville Rd Westbound				n/a Northbound				2nd Ave Southbound				15-min Total	Rolling One Hour
	UT	LT	TH	RT	UT	LT	TH	RT	UT	LT	TH	RT	UT	LT	TH	RT		
4:00 PM	0	0	0	0	0	0	0	0	0	0	0	0	0	0	0	0	0	0
4:15 PM	0	0	0	0	0	0	0	0	0	0	0	0	0	0	0	0	0	0
4:30 PM	0	0	1	0	0	0	0	0	0	0	0	0	0	0	0	0	1	0
4:45 PM	0	0	0	0	0	0	0	0	0	0	0	0	0	0	0	0	0	1
Count Total	0	0	1	0	0	0	0	0	0	0	0	0	0	0	0	0	1	1
Peak Hour	0	0	1	0	0	0	0	0	0	0	0	0	0	0	0	0	1	1

Two-Hour Count Summaries - Bikes

Interval Start	Coombsville Rd Eastbound				Coombsville Rd Westbound				n/a Northbound				2nd Ave Southbound				15-min Total	Rolling One Hour
	UT	LT	TH	RT	UT	LT	TH	RT	UT	LT	TH	RT	UT	LT	TH	RT		
4:00 PM	0	1	0	0	0	0	0	0	0	0	0	0	0	0	0	0	0	0
4:15 PM	0	0	0	0	0	1	0	0	0	0	0	0	0	0	0	0	0	1
4:30 PM	0	0	0	0	0	0	0	0	0	0	0	0	0	0	0	0	0	0
4:45 PM	0	0	0	0	0	0	0	0	0	0	0	0	0	0	0	0	0	2
Count Total	0	1	0	0	0	1	0	0	0	0	0	0	0	0	0	0	0	2
Peak Hour	0	1	0	0	0	1	0	0	0	0	0	0	0	0	0	0	0	2

Note: U-Turn volumes for bikes are included in Left-Turn, if any.

Two-Hour Count Summaries

Interval Start	Coombsville Rd Eastbound				Coombsville Rd Westbound				n/a Northbound				2nd Ave Southbound				15-min Total	Rolling One Hour
	UT	LT	TH	RT	UT	LT	TH	RT	UT	LT	TH	RT	UT	LT	TH	RT		
4:00 PM	0	3	26	0	0	0	26	1	0	0	0	0	0	2	0	6	65	0
4:15 PM	0	3	29	0	0	0	30	1	0	0	0	0	0	2	0	6	71	0
4:30 PM	0	7	24	0	0	0	35	1	0	0	0	0	0	0	0	8	75	0
4:45 PM	0	5	35	0	0	0	31	1	0	0	0	0	0	1	0	4	77	288
Count Total	0	18	114	0	0	0	122	4	0	0	0	0	0	5	0	24	268	0
Peak Hour	0	18	114	0	0	0	122	4	0	0	0	0	0	5	0	24	268	0
Peak Hour HV%	-	0%	1%	-	-	0%	1%	-	-	0%	0%	-	-	0%	0%	-	0%	0%

Interval Start	Heavy Vehicle Totals				Bicycles				Pedestrians (Crossing Leg)			
	EB	WB	NB	SB	Total	East	West	South	Total	East	West	South
4:00 PM	0	0	0	0	0	1	0	0	0	0	0	0
4:15 PM	0	0	0	0	0	1	0	0	0	0	0	2
4:30 PM	1	0	0	0	0	0	0	0	0	0	0	0
4:45 PM	0	0	0	0	0	0	0	0	0	0	0	0
Count Total	1	0	0	0	1	1	0	0	0	0	0	2
Peak Hour	1	0	0	0	1	1	0	0	0	0	0	2

Note: Two-hour count summary volumes include heavy vehicles but exclude bicycles in overall count.

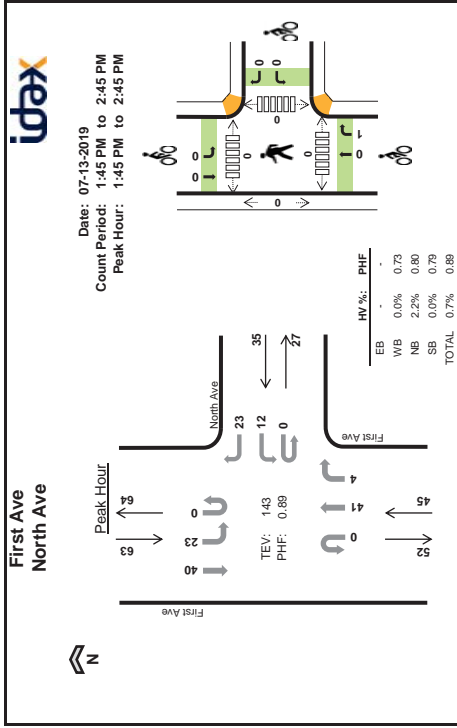

Interval Start	Two-Hour Count Summaries - Heavy Vehicles												Rolling One Hour			
	n/a			North Ave			First Ave			First Ave				15-min Total		
	UT	LT	TH	RT	UT	TH	RT	UT	TH	RT	UT	TH			RT	
1:45 PM	0	0	0	0	0	0	0	0	0	0	0	0	0	0	0	0
2:00 PM	0	0	0	0	0	0	0	0	0	0	0	0	0	0	0	0
2:15 PM	0	0	0	0	0	0	0	0	0	0	0	0	0	0	0	0
2:30 PM	0	0	0	0	0	0	0	0	0	0	0	0	0	0	0	0
Count Total	0	0	0	0	0	0	0	0	0	0	0	0	0	0	0	0
Peak Hour	0	0	0	0	0	0	0	0	0	0	0	0	0	0	0	0

Interval Start	Two-Hour Count Summaries - Bikes												Rolling One Hour			
	n/a			North Ave			First Ave			First Ave				15-min Total		
	LT	TH	RT	LT	TH	RT	LT	TH	RT	LT	TH	RT				
1:45 PM	0	0	0	0	0	0	0	0	0	0	0	0	0	0	0	0
2:00 PM	0	0	0	0	0	0	0	0	0	0	0	0	0	0	0	0
2:15 PM	0	0	0	0	0	0	0	0	0	0	0	0	0	0	0	0
2:30 PM	0	0	0	0	0	0	0	0	0	0	0	0	0	0	0	0
Count Total	0	0	0	0	0	0	0	0	0	0	0	0	0	0	0	0
Peak Hour	0	0	0	0	0	0	0	0	0	0	0	0	0	0	0	0

Note: U-Turn volumes for bikes are included in Left-Turn, if any.

Interval Start	Two-Hour Count Summaries																								Rolling One Hour	
	n/a						North Ave						First Ave						First Ave							15-min Total
	UT	LT	TH	RT	UT	TH	RT	UT	TH	RT	UT	TH	RT	UT	TH	RT	UT	TH	RT	UT	TH	RT				
1:45 PM	0	0	0	0	0	0	0	0	0	0	0	0	0	0	0	0	0	0	0	0	0	0	0	0	0	
2:00 PM	0	0	0	0	0	0	0	0	0	0	0	0	0	0	0	0	0	0	0	0	0	0	0	0	0	
2:15 PM	0	0	0	0	0	0	0	0	0	0	0	0	0	0	0	0	0	0	0	0	0	0	0	0	0	
2:30 PM	0	0	0	0	0	0	0	0	0	0	0	0	0	0	0	0	0	0	0	0	0	0	0	0	0	
Count Total	0	0	0	0	0	0	0	0	0	0	0	0	0	0	0	0	0	0	0	0	0	0	0	0	0	
Peak Hour	0	0	0	0	0	0	0	0	0	0	0	0	0	0	0	0	0	0	0	0	0	0	0	0	0	
HV%	0	0	0	0	0	0	0	0	0	0	0	0	0	0	0	0	0	0	0	0	0	0	0	0	0	

Interval Start	Heavy Vehicle Totals						Bicycles						Pedestrians (Crossing Leg)					
	EB	WB	NB	SB	Total	Count	EB	WB	NB	SB	Total	Count	East	West	North	South	Total	
1:45 PM	0	0	0	0	0	0	0	0	0	0	0	0	0	0	0	0	0	
2:00 PM	0	0	0	0	0	0	0	0	0	0	0	0	0	0	0	0	0	
2:15 PM	0	0	0	0	0	0	0	0	0	0	0	0	0	0	0	0	0	
2:30 PM	0	0	0	0	0	0	0	0	0	0	0	0	0	0	0	0	0	
Count Total	0	0	0	0	0	0	0	0	0	0	0	0	0	0	0	0	0	
Peak Hr	0	0	0	0	0	0	0	0	0	0	0	0	0	0	0	0	0	

Note: Two-hour count summary volumes include heavy vehicles but exclude bicycles in overall count.

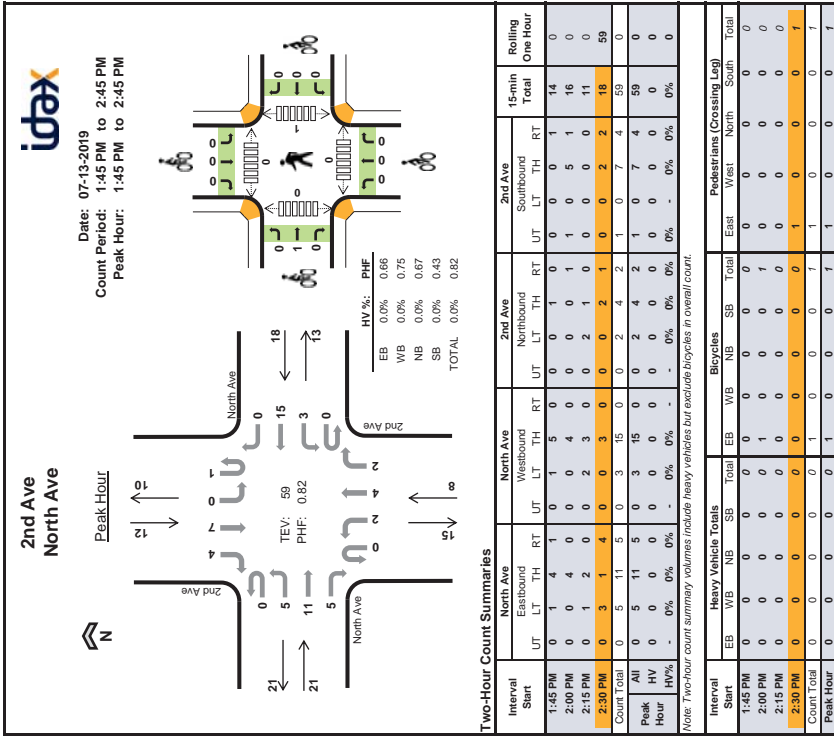

Two-Hour Count Summaries - Heavy Vehicles

Interval Start	North Ave Eastbound			North Ave Westbound			2nd Ave Northbound			2nd Ave Southbound			15-min Total	Rolling One Hour
	UT			RT			UT			RT				
	LT	TH	RT	LT	TH	RT	LT	TH	RT	LT	TH	RT		
1:45 PM	0	0	0	0	0	0	0	0	0	0	0	0	0	0
2:00 PM	0	0	0	0	0	0	0	0	0	0	0	0	0	0
2:15 PM	0	0	0	0	0	0	0	0	0	0	0	0	0	0
2:30 PM	0	0	0	0	0	0	0	0	0	0	0	0	0	0
Count Total	0	0	0	0	0	0	0	0	0	0	0	0	0	0
Peak Hour	0	0	0	0	0	0	0	0	0	0	0	0	0	0

Two-Hour Count Summaries - Bikes

Interval Start	North Ave Eastbound			North Ave Westbound			2nd Ave Northbound			2nd Ave Southbound			15-min Total	Rolling One Hour
	UT			RT			UT			RT				
	LT	TH	RT	LT	TH	RT	LT	TH	RT	LT	TH	RT		
1:45 PM	0	0	0	0	0	0	0	0	0	0	0	0	0	0
2:00 PM	0	1	0	0	0	0	0	0	0	0	0	0	1	0
2:15 PM	0	0	0	0	0	0	0	0	0	0	0	0	0	0
2:30 PM	0	0	0	0	0	0	0	0	0	0	0	0	0	1
Count Total	0	1	0	0	0	0	0	0	0	0	0	0	1	1
Peak Hour	0	1	0	0	0	0	0	0	0	0	0	0	1	1

Note: LT-Turn volumes for bikes are included in Left-Turn, if any.

Two-Hour Count Summaries

Interval Start	North Ave Eastbound			North Ave Westbound			2nd Ave Northbound			2nd Ave Southbound			15-min Total	Rolling One Hour
	UT			RT			UT			RT				
	LT	TH	RT	LT	TH	RT	LT	TH	RT	LT	TH	RT		
1:45 PM	0	1	4	0	1	5	0	0	1	0	0	0	14	0
2:00 PM	0	4	0	0	4	0	0	0	0	1	0	5	16	0
2:15 PM	0	1	2	0	0	2	3	0	2	1	0	0	11	0
2:30 PM	0	3	4	0	0	3	0	0	2	1	0	2	18	59
Count Total	0	5	11	0	3	15	0	0	2	4	2	7	59	59
Peak Hour	0	5	11	0	3	15	0	0	2	4	2	7	59	59
HV%	0	0	0	0	0	0	0	0	0	0	0	0	0	0
HV%	-	0%	0%	-	0%	0%	-	0%	0%	0%	0%	0%	0%	0%

Heavy Vehicle Totals

Interval Start	EB	WB	NB	SB	Total
1:45 PM	0	0	0	0	0
2:00 PM	0	0	0	1	1
2:15 PM	0	0	0	0	0
2:30 PM	0	0	0	1	1
Count Total	0	0	0	1	1
Peak Hour	0	0	0	1	1

Bicycles

Interval Start	EB	WB	NB	SB	Total
1:45 PM	0	0	0	0	0
2:00 PM	0	0	0	0	0
2:15 PM	0	0	0	0	0
2:30 PM	0	0	0	0	0
Count Total	0	0	0	0	0
Peak Hour	0	0	0	0	0

Pedestrians (Crossing Leg)

Interval Start	East	West	North	South	Total
1:45 PM	0	0	0	0	0
2:00 PM	0	0	0	0	0
2:15 PM	0	0	0	0	0
2:30 PM	0	0	0	0	0
Count Total	0	0	0	0	0
Peak Hour	0	0	0	0	0

Note: Two-hour count summary volumes include heavy vehicles but exclude bicycles in overall count.

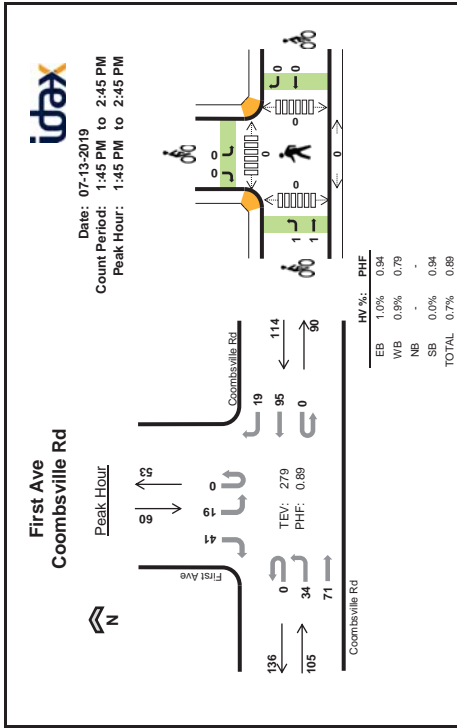

Two-Hour Count Summaries - Heavy Vehicles

Interval Start	Coombsville Rd Eastbound			Coombsville Rd Westbound			n/a Northbound			n/a Southbound			15-min Total	Rolling One Hour	
	UT	LT	TH	RT	LT	TH	RT	LT	TH	RT	LT	TH			RT
1:45 PM	0	0	0	0	0	0	0	0	0	0	0	0	0	0	0
2:00 PM	0	0	0	0	0	0	0	0	0	0	0	0	0	0	0
2:15 PM	0	0	0	0	0	0	0	0	0	0	0	0	0	0	0
2:30 PM	0	0	0	0	0	0	0	0	0	0	0	0	0	0	0
Count Total	0	0	0	0	0	0	0	0	0	0	0	0	0	0	0
Peak Hour	0	0	0	0	0	0	0	0	0	0	0	0	0	0	0

Two-Hour Count Summaries - Bikes

Interval Start	Coombsville Rd Eastbound			Coombsville Rd Westbound			n/a Northbound			n/a Southbound			15-min Total	Rolling One Hour	
	UT	LT	TH	RT	LT	TH	RT	LT	TH	RT	LT	TH			RT
1:45 PM	1	1	0	0	0	0	0	0	0	0	0	0	0	2	0
2:00 PM	0	0	0	0	0	0	0	0	0	0	0	0	0	0	0
2:15 PM	0	0	0	0	0	0	0	0	0	0	0	0	0	0	0
2:30 PM	0	0	0	0	0	0	0	0	0	0	0	0	0	0	0
Count Total	1	1	0	0	0	0	0	0	0	0	0	0	0	2	0
Peak Hour	1	1	0	0	0	0	0	0	0	0	0	0	0	2	0

Note: U-Turn volumes for bikes are included in Left-Turn, if any.

Two-Hour Count Summaries

Interval Start	Coombsville Rd Eastbound			Coombsville Rd Westbound			n/a Northbound			n/a Southbound			15-min Total	Rolling One Hour	
	UT	LT	TH	RT	LT	TH	RT	UT	LT	TH	RT				
1:45 PM	0	4	23	0	0	0	24	1	0	0	0	0	4	0	11
2:00 PM	0	13	15	0	0	0	28	8	0	0	0	0	4	0	10
2:15 PM	0	9	14	0	0	0	16	3	0	0	0	0	5	0	10
2:30 PM	0	8	19	0	0	0	27	7	0	0	0	0	6	0	10
Count Total	0	34	71	0	0	0	95	19	0	0	0	0	19	0	41
Peak Hour	0	34	71	0	0	0	95	19	0	0	0	0	19	0	41
Peak Hour HV%	0	0%	1%	0	0	0	1%	0%	0	0	0	0	0	0%	2

Interval Start	Heavy Vehicle Totals			Bicycles			Pedestrians (Crossing Loop)		
	EB	WB	NB	SB	Total	East	West	South	Total
1:45 PM	0	0	0	0	0	2	0	0	2
2:00 PM	0	1	0	0	1	0	0	0	0
2:15 PM	0	0	0	0	0	0	0	0	0
2:30 PM	1	0	0	0	1	0	0	0	0
Count Total	1	1	0	0	2	0	0	0	2
Peak Hr	1	1	0	0	2	0	0	0	2

Note: Two-hour count summary volumes include heavy vehicles but exclude bicycles in overall count.

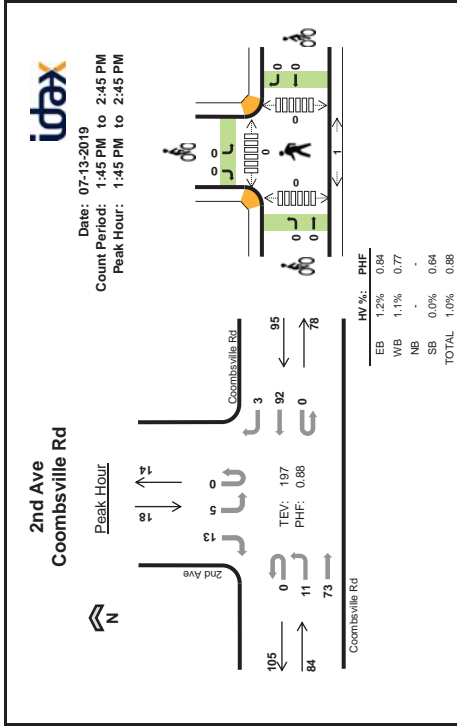

Two-Hour Count Summaries - Heavy Vehicles																								
Interval Start	Coombsville Rd Eastbound						Coombsville Rd Westbound						n/a						2nd Ave Southbound					
	UT	LT	TH	RT	UT	TH	UT	LT	TH	RT	UT	TH	UT	LT	TH	RT	UT	LT	TH	RT				
1:45 PM	0	0	0	0	0	0	0	0	0	0	0	0	0	0	0	0	0	0	0	0				
2:00 PM	0	0	0	0	0	0	0	0	0	0	0	0	0	0	0	0	0	0	0	0				
2:15 PM	0	0	0	0	0	0	0	0	0	0	0	0	0	0	0	0	0	0	0	0				
2:30 PM	0	0	1	0	0	0	0	0	0	0	0	0	0	0	0	0	0	0	0	0				
Count Total	0	0	1	0	0	0	0	0	0	0	0	0	0	0	0	0	0	0	0	0				
Peak Hour	0	0	1	0	0	0	0	0	0	0	0	0	0	0	0	0	0	0	0	0				
Rolling One Hour	0	0	1	0	0	0	0	0	0	0	0	0	0	0	0	0	0	0	0	0				

Two-Hour Count Summaries - Bikes																								
Interval Start	Coombsville Rd Eastbound						Coombsville Rd Westbound						n/a						2nd Ave Southbound					
	LT	TH	RT	UT	TH	RT	LT	TH	RT	UT	TH	LT	TH	RT	UT	TH	LT	TH	RT	UT	TH			
1:45 PM	0	0	0	0	0	0	0	0	0	0	0	0	0	0	0	0	0	0	0	0	0			
2:00 PM	0	0	0	0	0	0	0	0	0	0	0	0	0	0	0	0	0	0	0	0	0			
2:15 PM	0	0	0	0	0	0	0	0	0	0	0	0	0	0	0	0	0	0	0	0	0			
2:30 PM	0	0	0	0	0	0	0	0	0	0	0	0	0	0	0	0	0	0	0	0	0			
Count Total	0	0	0	0	0	0	0	0	0	0	0	0	0	0	0	0	0	0	0	0	0			
Peak Hour	0	0	0	0	0	0	0	0	0	0	0	0	0	0	0	0	0	0	0	0	0			
Rolling One Hour	0	0	0	0	0	0	0	0	0	0	0	0	0	0	0	0	0	0	0	0	0			

Note: U-Turn volumes for bikes are included in Left-Turn, if any.

Two-Hour Count Summaries																								
Interval Start	Coombsville Rd Eastbound						Coombsville Rd Westbound						n/a						2nd Ave Southbound					
	UT	LT	TH	RT	UT	TH	UT	LT	TH	RT	UT	TH	UT	LT	TH	RT	UT	LT	TH	RT				
1:45 PM	0	5	20	0	0	18	0	0	0	0	0	0	0	0	0	0	0	0	0	0				
2:00 PM	0	1	19	0	0	25	0	0	0	0	0	0	0	0	0	0	0	0	0	0				
2:15 PM	0	3	15	0	0	20	1	0	0	0	0	0	0	0	0	0	0	0	0	0				
2:30 PM	0	2	19	0	0	29	2	0	0	0	0	0	0	0	0	0	0	0	0	0				
Count Total	0	11	73	0	0	92	3	0	0	0	0	0	0	0	0	0	0	0	0	0				
Peak Hour	0	11	73	0	0	92	3	0	0	0	0	0	0	0	0	0	0	0	0	0				
Rolling One Hour	0	11	73	0	0	92	3	0	0	0	0	0	0	0	0	0	0	0	0	0				
Peak Hour HV%	-	0%	1%	-	-	1%	0%	-	-	-	-	-	-	-	-	-	-	-	-	-				
Peak Hour HV%	-	0%	1%	-	-	1%	0%	-	-	-	-	-	-	-	-	-	-	-	-	-				

Heavy Vehicle Totals												Bicycles						Pedestrians (Crossing Leg)					
Interval Start	EB	WB	NB	SB	Total	East	West	South	Total	East	West	North	South	Total									
1:45 PM	0	0	0	0	0	0	0	0	0	0	0	0	0	0									
2:00 PM	0	1	0	0	1	0	0	0	0	0	0	0	0	0									
2:15 PM	0	0	0	0	0	0	0	0	0	0	0	0	0	0									
2:30 PM	1	0	0	0	1	0	0	0	0	0	0	0	0	0									
Count Total	1	1	0	0	2	0	0	0	0	0	0	0	0	0									
Peak Hour	1	1	0	0	2	0	0	0	0	0	0	0	0	0									
Rolling One Hour	1	1	0	0	2	0	0	0	0	0	0	0	0	0									

Note: Two-hour count summary volumes include heavy vehicles but exclude bicycles in overall count.

Appendix C

Intersection Level of Service Calculations





This page intentionally left blank

Intersection Level Of Service Report

Control Type: Two-way stop
 Analysis Method: HCM 6th Edition
 Analysis Period: 15 minutes

Delay (sec / veh): 10.3
 Level Of Service: B
 Volume to Capacity (v/c): 0.011

Intersection Setup

Name	First Ave	First Ave	North Ave
Approach	Northbound	Southbound	Westbound
Lane Configuration	Thru Right	Thru Left	Right
Turning Movement	Thru Right	Thru Left	Right
Lane Width [ft]	12.00	12.00	12.00
No. of Lanes in Pocket	0	0	0
Pocket Length [ft]	100.00	100.00	100.00
Speed [mph]	40.00	40.00	40.00
Grade [%]	0.00	0.00	0.00
Crosswalk	No	No	No

Volumes

Name	First Ave	First Ave	North Ave
Base Volume Input [veh/h]	76	33	73
Base Volume Adjustment Factor	1.0000	1.0000	1.0000
Heavy Vehicles Percentage [%]	0.00	3.00	0.00
Growth Factor	1.0000	1.0000	1.0000
In-Process Volume [veh/h]	0	0	0
Site-Generated Trips [veh/h]	0	0	0
Diverted Trips [veh/h]	0	0	0
Pass-by Trips [veh/h]	0	0	0
Existing Site Adjustment Volume [veh/h]	0	0	0
Other Volume [veh/h]	0	0	0
Total Hourly Volume [veh/h]	76	33	73
Peak Hour Factor	0.8300	0.8300	0.8300
Other Adjustment Factor	1.0000	1.0000	1.0000
Total 15-Minute Volume [veh/h]	23	10	22
Total Analysis Volume [veh/h]	92	40	86
Pedestrian Volume [ped/h]	0	0	0

Intersection Settings

Priority Scheme	Free	Free	Stop
Flared Lane			No
Storage Area [veh]	0	0	0
Two-Stage Gap Acceptance			No
Number of Storage Spaces in Median	0	0	0

Movement, Approach, & Intersection Results

V/C	Movement V/C Ratio	0.00	0.00	0.03	0.00	0.01	0.05
d_M	Delay for Movement [s/veh]	0.00	0.00	7.48	0.00	10.32	8.97
	Movement LOS	A	A	A	A	B	A
95th-Percentile Queue Length [veh/ln]		0.00	0.00	0.08	0.08	0.19	0.19
95th-Percentile Queue Length [ft/ln]		0.00	0.00	2.07	2.07	4.85	4.85
d_A	Approach Delay [s/veh]	0.00	0.00	2.34	A	9.16	A
	Approach LOS	A	A	A	A	A	A
d_I	Intersection Delay [s/veh]			2.90	B		
	Intersection LOS				B		

Intersection Level Of Service Report
Intersection 2: Second Avenue/North Avenue

Control Type: Two-way stop
 Analysis Method: HCM 6th Edition
 Analysis Period: 15 minutes

Delay (sec / veh): 9.5
 Level Of Service: A
 Volume to Capacity (v/c): 0.012

Intersection Setup

Name	Second Avenue		Second Avenue		North Ave		North Avenue		
	Northbound	Southbound	Eastbound	Westbound	Eastbound	Westbound	Eastbound	Westbound	
Approach	+		+		+		+		
Lane Configuration	+		+		+		+		
Turning Movement	Left	Thru	Right	Left	Thru	Right	Left	Thru	Right
Lane Width [ft]	12.00	12.00	12.00	12.00	12.00	12.00	12.00	12.00	12.00
No. of Lanes in Pocket	0	0	0	0	0	0	0	0	0
Pocket Length [ft]	100.00	100.00	100.00	100.00	100.00	100.00	100.00	100.00	100.00
Speed [mph]	40.00		40.00		40.00		40.00		
Grade [%]	0.00		0.00		0.00		0.00		
Crosswalk	No		No		No		No		

Volumes

Name	Second Avenue		Second Avenue		North Ave		North Avenue			
	6	8	6	9	2	21	10	3	31	1
Base Volume Input [veh/h]	1,000	1,000	1,000	1,000	1,000	1,000	1,000	1,000	1,000	1,000
Base Volume Adjustment Factor	1.000	1.000	1.000	1.000	1.000	1.000	1.000	1.000	1.000	1.000
Heavy Vehicles Percentage [%]	0.00	0.00	0.00	0.00	0.00	0.00	10.00	0.00	0.00	0.00
Growth Factor	1.000	1.000	1.000	1.000	1.000	1.000	1.000	1.000	1.000	1.000
In-Process Volume [veh/h]	0	0	0	0	0	0	0	0	0	0
Site-Generated Trips [veh/h]	0	0	0	0	0	0	0	0	0	0
Diverted Trips [veh/h]	0	0	0	0	0	0	0	0	0	0
Pass-by Trips [veh/h]	0	0	0	0	0	0	0	0	0	0
Existing Site Adjustment Volume [veh/h]	0	0	0	0	0	0	0	0	0	0
Other Volume [veh/h]	0	0	0	0	0	0	0	0	0	0
Total Hourly Volume [veh/h]	6	8	6	9	6	2	21	10	3	31
Peak Hour Factor	0.8900	0.8900	0.8900	0.8900	0.8900	0.8900	0.8900	0.8900	0.8900	0.8900
Other Adjustment Factor	1.0000	1.0000	1.0000	1.0000	1.0000	1.0000	1.0000	1.0000	1.0000	1.0000
Total 15-Minute Volume [veh/h]	2	2	2	3	2	1	6	3	1	9
Total Analysis Volume [veh/h]	7	9	7	10	7	2	24	11	3	35
Pedestrian Volume [ped/h]	0	0	0	0	0	0	0	0	0	0



Intersection Settings

Priority Scheme	Stop	Stop	Stop	Free
Flared Lane	Yes			
Storage Area [veh]	1			
Two-Stage Gap Acceptance	No			
Number of Storage Spaces in Median	0			

Movement, Approach, & Intersection Results

Movement	V/C Ratio	d_M Delay [s/veh]	95th-Percentile Queue Length [veh]	95th-Percentile Queue Length [ft]	d_A Approach Delay [s/veh]	Approach LOS	d_I Intersection Delay [s/veh]	Intersection LOS
V/C, Movement V/C Ratio	0.01	0.01	0.01	0.01	0.01	A	3.44	A
d_M Delay for Movement [s/veh]	9.09	9.47	8.48	9.11	9.52	A	7.27	A
Movement LOS	A	A	A	A	A	A	A	A
95th-Percentile Queue Length [veh]	0.06	0.06	0.06	0.06	0.06	A	0.06	A
95th-Percentile Queue Length [ft]	1.44	1.44	1.44	1.46	1.46	A	0.09	A
d_A Approach Delay [s/veh]	9.05				9.11		0.39	
Approach LOS	A				A		A	
d_I Intersection Delay [s/veh]							3.44	A
Intersection LOS							A	



Intersection Level Of Service Report

Control Type: Two-way stop
 Analysis Method: HCM 6th Edition
 Analysis Period: 15 minutes

Delay (sec / veh): 12.2
 Level Of Service: B
 Volume to Capacity (v/c): 0.062

Intersection Setup

Name	First Ave	Coombsville Rd	Coombsville Rd
Approach	Southbound	Eastbound	Westbound
Lane Configuration	T	T	T
Turning Movement	Left Right	Left Thru Right	Thru Right
Lane Width [ft]	12.00	12.00	12.00
No. of Lanes in Pocket	0	0	0
Pocket Length [ft]	100.00	100.00	100.00
Speed [mph]	40.00	40.00	40.00
Grade [%]	0.00	0.00	0.00
Crosswalk	No	Yes	No

Volumes

Name	First Ave	Coombsville Rd	Coombsville Rd
Base Volume Input [veh/h]	31	61	125
Base Volume Adjustment Factor	1.0000	1.0000	1.0000
Heavy Vehicles Percentage [%]	0.00	2.00	1.00
Growth Factor	1.0000	1.0000	1.0000
In-Process Volume [veh/h]	0	0	0
Site-Generated Trips [veh/h]	0	0	0
Diverted Trips [veh/h]	0	0	0
Pass-by Trips [veh/h]	0	0	0
Existing Site Adjustment Volume [veh/h]	0	0	0
Other Volume [veh/h]	0	0	0
Total Hourly Volume [veh/h]	31	61	125
Peak Hour Factor	0.8900	0.8900	0.8900
Other Adjustment Factor	1.0000	1.0000	1.0000
Total 15-Minute Volume [veh/h]	9	17	35
Total Analysis Volume [veh/h]	35	62	140
Pedestrian Volume [ped/h]	0	1	0

Intersection Settings

Priority Scheme	Stop	Free	Free
Flared Lane	No		
Storage Area [veh]	0	0	0
Two-Stage Gap Acceptance	No		
Number of Storage Spaces in Median	0	0	0

Movement, Approach, & Intersection Results

V/C, Movement V/C Ratio	0.06	0.07	0.05	0.00	0.00
d_M, Delay for Movement [s/veh]	12.16	9.79	7.70	0.00	0.00
Movement LOS	B	A	A	A	A
95th-Percentile Queue Length [veh/ln]	0.45	0.45	0.16	0.00	0.00
95th-Percentile Queue Length [ft/ln]	11.34	11.34	3.88	0.00	0.00
d_A, Approach Delay [s/veh]	10.64		2.73		
Approach LOS	B		A		A
d_I, Intersection Delay [s/veh]			3.34		
Intersection LOS			B		

Intersection Level Of Service Report

Control Type: Two-way stop
 Analysis Method: HCM 6th Edition
 Analysis Period: 15 minutes

Delay (sec / veh): 10.3
 Level Of Service: B
 Volume to Capacity (v/c): 0.009

Intersection Setup

Name	Second Avenue	Coombsville Rd	Coombsville Rd
Approach	Southbound	Eastbound	Westbound
Lane Configuration	T	T	T
Turning Movement	Left Right	Left Thru Right	Thru Right
Lane Width [ft]	12.00 12.00	12.00 12.00	12.00 12.00
No. of Lanes in Pocket	0 0	0 0	0 0
Pocket Length [ft]	100.00 100.00	100.00 100.00	100.00 100.00
Speed [mph]	40.00	40.00	40.00
Grade [%]	0.00	0.00	0.00
Crosswalk	No	Yes	No

Volumes

Name	Second Avenue	Coombsville Rd	Coombsville Rd
Base Volume Input [veh/h]	6 24	18 114	122 4
Base Volume Adjustment Factor	1.0000 1.0000	1.0000 1.0000	1.0000 1.0000
Heavy Vehicles Percentage [%]	0.00 0.00	0.00 1.00	0.00 0.00
Growth Factor	1.0000 1.0000	1.0000 1.0000	1.0000 1.0000
In-Process Volume [veh/h]	0 0	0 0	0 0
Site-Generated Trips [veh/h]	0 0	0 0	0 0
Diverted Trips [veh/h]	0 0	0 0	0 0
Pass-by Trips [veh/h]	0 0	0 0	0 0
Existing Site Adjustment Volume [veh/h]	0 0	0 0	0 0
Other Volume [veh/h]	0 0	0 0	0 0
Total Hourly Volume [veh/h]	6 24	18 114	122 4
Peak Hour Factor	0.9400 0.9400	0.9400 0.9400	0.9400 0.9400
Other Adjustment Factor	1.0000 1.0000	1.0000 1.0000	1.0000 1.0000
Total 15-Minute Volume [veh/h]	2 6	5 30	32 1
Total Analysis Volume [veh/h]	6 26	19 121	130 4
Pedestrian Volume [ped/h]	0 0	0 0	0 0

Intersection Settings

Priority Scheme	Stop	Free	Free
Flared Lane	Yes		
Storage Area [veh]	1	0	0
Two-Stage Gap Acceptance	No		
Number of Storage Spaces in Median	0	0	0

Movement, Approach, & Intersection Results

V/C, Movement V/C Ratio	0.01	0.03	0.01	0.01	0.00	0.00	0.00
d_M, Delay for Movement [s/veh]	10.28	8.99	7.49	7.49	0.00	0.00	0.00
Movement LOS	B	A	A	A	A	A	A
95th-Percentile Queue Length [veh/ln]	0.09	0.09	0.04	0.04	0.04	0.00	0.00
95th-Percentile Queue Length [ft/ln]	2.17	2.17	0.89	0.89	0.99	0.00	0.00
d_A, Approach Delay [s/veh]	9.23		1.02	1.02			
Approach LOS	A		A	A			A
d_I, Intersection Delay [s/veh]			1.43	1.43			
Intersection LOS			B	B			

Intersection Level Of Service Report

Control Type: Two-way stop
 Analysis Method: HCM 6th Edition
 Analysis Period: 15 minutes
 Delay (sec / veh): 9.5
 Level Of Service: A
 Volume to Capacity (v/c): 0.016

Intersection Setup

Name	First Ave	Southbound	North Ave
Approach	Northbound	Southbound	Westbound
Lane Configuration	Thru	Thru	Right
Turning Movement	Right	Left	Left
Lane Width [ft]	12.00	12.00	12.00
No. of Lanes in Pocket	0	0	0
Pocket Length [ft]	100.00	100.00	100.00
Speed [mph]	40.00	40.00	40.00
Grade [%]	0.00	0.00	0.00
Crosswalk	No	No	No

Volumes

Name	First Ave	First Ave	North Ave
Base Volume Input [veh/h]	41	23	23
Base Volume Adjustment Factor	1.0000	1.0000	1.0000
Heavy Vehicles Percentage [%]	0.00	0.00	0.00
Growth Factor	1.0000	1.0000	1.0000
In-Process Volume [veh/h]	0	0	0
Site-Generated Trips [veh/h]	0	0	0
Diverted Trips [veh/h]	0	0	0
Pass-by Trips [veh/h]	0	0	0
Existing Site Adjustment Volume [veh/h]	0	0	0
Other Volume [veh/h]	0	0	0
Total Hourly Volume [veh/h]	41	23	23
Peak Hour Factor	0.8900	0.8900	0.8900
Other Adjustment Factor	1.0000	1.0000	1.0000
Total 15-Minute Volume [veh/h]	12	6	3
Total Analysis Volume [veh/h]	46	26	13
Pedestrian Volume [ped/h]	0	0	0

Intersection Settings

Priority Scheme	Free	Free	Stop
Flared Lane			No
Storage Area [veh]	0	0	0
Two-Stage Gap Acceptance			No
Number of Storage Spaces in Median	0	0	0

Movement, Approach, & Intersection Results

V/C	Movement V/C Ratio	0.00	0.00	0.02	0.00	0.02	0.02	0.03
d_M	Delay for Movement [s/veh]	0.00	0.00	7.33	0.00	9.46	8.67	
	Movement LOS	A	A	A	A	A	A	
95th-Percentile Queue Length [veh/ln]		0.00	0.00	0.05	0.05	0.13	0.13	
95th-Percentile Queue Length [ft/ln]		0.00	0.00	1.26	1.26	3.19	3.19	
d_A	Approach Delay [s/veh]	0.00	0.00	2.69	2.69	8.93		
	Approach LOS	A	A	A	A	A		
d_I	Intersection Delay [s/veh]			3.37				
	Intersection LOS			A				

Intersection Level Of Service Report

Control Type: Two-way stop
 Analysis Method: HCM 6th Edition
 Analysis Period: 15 minutes

Delay (sec / veh): 9.4
 Level Of Service: A
 Volume to Capacity (v/c): 0.011

Intersection Setup

Name	Second Avenue			Second Avenue			North Ave			North Avenue			
	Northbound	Southbound	Eastbound	Westbound	Thru	Left	Right	Thru	Left	Right	Thru	Left	Right
Approach	+			+			+			+			
Lane Configuration	+			+			+			+			
Turning Movement	12.00	12.00	12.00	12.00	12.00	12.00	12.00	12.00	12.00	12.00	12.00	12.00	12.00
Lane Width [ft]	0	0	0	0	0	0	0	0	0	0	0	0	0
No. of Lanes in Pocket	100.00	100.00	100.00	100.00	100.00	100.00	100.00	100.00	100.00	100.00	100.00	100.00	100.00
Pocket Length [ft]	40.00			40.00			40.00			40.00			
Speed [mph]	0.00			0.00			0.00			0.00			
Grade [%]	No			No			No			No			
Crosswalk	No			No			No			No			

Volumes

Name	Second Avenue			Second Avenue			North Ave			North Avenue		
	2	4	7	1	7	4	5	11	5	3	15	0
Base Volume Input [veh/h]	1.0000	1.0000	1.0000	1.0000	1.0000	1.0000	1.0000	1.0000	1.0000	1.0000	1.0000	1.0000
Base Volume Adjustment Factor	0.00	0.00	0.00	0.00	0.00	0.00	0.00	0.00	0.00	0.00	0.00	0.00
Heavy Vehicles Percentage [%]	1.0000	1.0000	1.0000	1.0000	1.0000	1.0000	1.0000	1.0000	1.0000	1.0000	1.0000	1.0000
Growth Factor	0	0	0	0	0	0	0	0	0	0	0	0
In-Process Volume [veh/h]	0	0	0	0	0	0	0	0	0	0	0	0
Site-Generated Trips [veh/h]	0	0	0	0	0	0	0	0	0	0	0	0
Diverted Trips [veh/h]	0	0	0	0	0	0	0	0	0	0	0	0
Pass-by Trips [veh/h]	0	0	0	0	0	0	0	0	0	0	0	0
Existing Site Adjustment Volume [veh/h]	0	0	0	0	0	0	0	0	0	0	0	0
Other Volume [veh/h]	2	4	2	1	7	4	5	11	5	3	15	0
Total Hourly Volume [veh/h]	0.8200	0.8200	0.8200	0.8200	0.8200	0.8200	0.8200	0.8200	0.8200	0.8200	0.8200	0.8200
Peak Hour Factor	1.0000	1.0000	1.0000	1.0000	1.0000	1.0000	1.0000	1.0000	1.0000	1.0000	1.0000	1.0000
Other Adjustment Factor	1	1	1	0	2	1	2	3	2	1	5	0
Total 15-Minute Volume [veh/h]	2	5	2	1	9	5	6	13	6	4	18	0
Total Analysis Volume [veh/h]	0			0			0			0		
Pedestrian Volume [ped/h]	0			0			0			0		



Intersection Settings

Priority Scheme	Stop	Stop	Stop	Free
Flared Lane	Yes	No	No	Free
Storage Area [veh]	1	0	0	0
Two-Stage Gap Acceptance	No	No	No	0
Number of Storage Spaces in Median	0	0	0	0

Movement, Approach, & Intersection Results

V/C, Movement V/C Ratio	0.00	0.01	0.00	0.00	0.01	0.00	0.00	0.00	0.00	0.00	0.00	0.00	0.00
d_M, Delay for Movement [s/veh]	8.93	9.33	8.39	8.92	9.39	8.44	7.24	0.00	0.00	7.24	0.00	0.00	0.00
Movement LOS	A	A	A	A	A	A	A	A	A	A	A	A	A
95th-Percentile Queue Length [veh/ln]	0.02	0.02	0.02	0.02	0.05	0.05	0.01	0.01	0.01	0.01	0.01	0.01	0.01
95th-Percentile Queue Length [ft/ln]	0.62	0.62	1.26	1.26	1.26	1.26	0.28	0.28	0.28	0.28	0.19	0.19	0.19
d_A, Approach Delay [s/veh]	9.03			9.04			1.74			1.32			
Approach LOS	A			A			A			A			
d_I, Intersection Delay [s/veh]	4.08			4.08			A			A			
Intersection LOS	A			A			A			A			



Intersection Level Of Service Report

Control Type: Two-way stop
 Analysis Method: HCM 6th Edition
 Analysis Period: 15 minutes

Delay (sec / veh): 10.5
 Level Of Service: B
 Volume to Capacity (v/c): 0.030

Intersection Setup

Name	First Ave	Coombsville Rd	Coombsville Rd
Approach	Southbound	Eastbound	Westbound
Lane Configuration	T	T	T
Turning Movement	Left Right	Left Thru Right	Thru Right
Lane Width [ft]	12.00	12.00	12.00
No. of Lanes in Pocket	0	0	0
Pocket Length [ft]	100.00	100.00	100.00
Speed [mph]	40.00	40.00	40.00
Grade [%]	0.00	0.00	0.00
Crosswalk	No	Yes	No

Volumes

Name	First Ave	Coombsville Rd	Coombsville Rd
Base Volume Input [veh/h]	19	34	71
Base Volume Adjustment Factor	1.0000	1.0000	1.0000
Heavy Vehicles Percentage [%]	0.00	0.00	1.00
Growth Factor	1.0000	1.0000	1.0000
In-Process Volume [veh/h]	0	0	0
Site-Generated Trips [veh/h]	0	0	0
Diverted Trips [veh/h]	0	0	0
Pass-by Trips [veh/h]	0	0	0
Existing Site Adjustment Volume [veh/h]	0	0	0
Other Volume [veh/h]	0	0	0
Total Hourly Volume [veh/h]	19	34	71
Peak Hour Factor	0.8900	0.8900	0.8900
Other Adjustment Factor	1.0000	1.0000	1.0000
Total 15-Minute Volume [veh/h]	5	10	20
Total Analysis Volume [veh/h]	21	38	80
Pedestrian Volume [ped/h]	0	0	0

Intersection Settings

Priority Scheme	Stop	Free	Free
Flared Lane	No		
Storage Area [veh]	0	0	0
Two-Stage Gap Acceptance	No		
Number of Storage Spaces in Median	0	0	0

Movement, Approach, & Intersection Results

V/C, Movement V/C Ratio	0.03	0.05	0.03	0.03	0.00	0.00
d_M, Delay for Movement [s/veh]	10.50	9.19	7.51	0.00	0.00	0.00
Movement LOS	B	A	A	A	A	A
95th-Percentile Queue Length [veh/ln]	0.26	0.26	0.08	0.08	0.00	0.00
95th-Percentile Queue Length [ft/ln]	6.41	6.41	1.89	1.99	0.00	0.00
d_A, Approach Delay [s/veh]	9.60		2.42			
Approach LOS	A		A			
d_I, Intersection Delay [s/veh]			2.97			
Intersection LOS			B			

Intersection Level Of Service Report
Intersection 4: Second Avenue/Coombsville Road

Control Type: Two-way stop
 Analysis Method: HCM 6th Edition
 Analysis Period: 15 minutes
 Delay (sec / veh): 9.7
 Level Of Service: A
 Volume to Capacity (v/c): 0.008

Intersection Setup

Name	Second Avenue	Coombsville Rd	Coombsville Rd
Approach	Southbound	Eastbound	Westbound
Lane Configuration	T	T	T
Turning Movement	Left Right	Left Thru Right	Thru Right
Lane Width [ft]	12.00 12.00	12.00 12.00	12.00 12.00
No. of Lanes in Pocket	0 0	0 0	0 0
Pocket Length [ft]	100.00 100.00	100.00 100.00	100.00 100.00
Speed [mph]	40.00	40.00	40.00
Grade [%]	0.00	0.00	0.00
Crosswalk	No	Yes	No

Volumes

Name	Second Avenue	Coombsville Rd	Coombsville Rd
Base Volume Input [veh/h]	5 13	11 73	92 3
Base Volume Adjustment Factor	1.0000 1.0000	1.0000 1.0000	1.0000 1.0000
Heavy Vehicles Percentage [%]	0.00 0.00	0.00 1.00	1.00 0.00
Growth Factor	1.0000 1.0000	1.0000 1.0000	1.0000 1.0000
In-Process Volume [veh/h]	0 0	0 0	0 0
Site-Generated Trips [veh/h]	0 0	0 0	0 0
Diverted Trips [veh/h]	0 0	0 0	0 0
Pass-by Trips [veh/h]	0 0	0 0	0 0
Existing Site Adjustment Volume [veh/h]	0 0	0 0	0 0
Other Volume [veh/h]	0 0	0 0	0 0
Total Hourly Volume [veh/h]	5 13	11 73	92 3
Peak Hour Factor	0.8800 0.8800	0.8800 0.8800	0.8800 0.8800
Other Adjustment Factor	1.0000 1.0000	1.0000 1.0000	1.0000 1.0000
Total 15-Minute Volume [veh/h]	1 4	3 21	26 1
Total Analysis Volume [veh/h]	6 15	13 83	105 3
Pedestrian Volume [ped/h]	0 0	0 0	0 0

Intersection Settings

Priority Scheme	Stop	Free	Free
Flared Lane	Yes		
Storage Area [veh]	1	0	0
Two-Stage Gap Acceptance	No		
Number of Storage Spaces in Median	0	0	0

Movement, Approach, & Intersection Results

V/C, Movement V/C Ratio	0.01	0.02	0.01	0.01	0.00	0.00	0.00
d_M, Delay for Movement [s/veh]	9.72	8.82	7.43	7.43	0.00	0.00	0.00
Movement LOS	A	A	A	A	A	A	A
95th-Percentile Queue Length [veh/ln]	0.05	0.05	0.03	0.03	0.00	0.00	0.00
95th-Percentile Queue Length [ft/ln]	1.20	1.20	0.66	0.66	0.00	0.00	0.00
d_A, Approach Delay [s/veh]	9.08		1.01	1.01			
Approach LOS	A	A	A	A	A	A	A
d_I, Intersection Delay [s/veh]			1.28	1.28			
Intersection LOS			A	A			

Intersection Level Of Service Report

Control Type: Two-way stop
 Analysis Method: HCM 6th Edition
 Analysis Period: 15 minutes

Delay (sec / veh): 10.2
 Level Of Service: B
 Volume to Capacity (v/c): 0.011

Intersection Setup

Name	First Ave	First Ave	North Ave
Approach	Northbound	Southbound	Westbound
Lane Configuration	Thru Right	Thru Left	Right
Turning Movement	Thru Right	Thru Left	Right
Lane Width [ft]	12.00	12.00	12.00
No. of Lanes in Pocket	0	0	0
Pocket Length [ft]	100.00	100.00	100.00
Speed [mph]	40.00	40.00	40.00
Grade [%]	0.00	0.00	0.00
Crosswalk	No	No	No

Volumes

Name	First Ave	First Ave	North Ave
Base Volume Input [veh/h]	76	33	7
Base Volume Adjustment Factor	1.0000	1.0000	1.0000
Heavy Vehicles Percentage [%]	0.00	3.00	0.00
Growth Factor	1.1400	1.1400	1.1400
In-Process Volume [veh/h]	0	0	0
Site-Generated Trips [veh/h]	0	0	0
Diverted Trips [veh/h]	0	0	0
Pass-by Trips [veh/h]	0	0	0
Existing Site Adjustment Volume [veh/h]	0	0	0
Other Volume [veh/h]	0	0	0
Total Hourly Volume [veh/h]	87	38	8
Peak Hour Factor	1.0000	1.0000	1.0000
Other Adjustment Factor	1.0000	1.0000	1.0000
Total 15-Minute Volume [veh/h]	22	10	2
Total Analysis Volume [veh/h]	87	38	8
Pedestrian Volume [ped/h]	0	0	0

Intersection Settings

Priority Scheme	Free	Free	Stop
Flared Lane			No
Storage Area [veh]	0	0	0
Two-Stage Gap Acceptance			No
Number of Storage Spaces in Median	0	0	0

Movement, Approach, & Intersection Results

V/C	Movement V/C Ratio	0.00	0.00	0.03	0.00	0.01	0.05
d_M	Delay for Movement [s/veh]	0.00	0.00	7.46	0.00	10.20	8.83
	Movement LOS	A	A	A	A	B	A
95th-Percentile Queue Length [veh/ln]		0.00	0.00	0.08	0.08	0.19	0.19
95th-Percentile Queue Length [ft/ln]		0.00	0.00	1.85	1.95	4.63	4.63
d_A	Approach Delay [s/veh]	0.00	0.00	2.34	A	9.12	A
	Approach LOS	A	A	A	A	A	A
d_I	Intersection Delay [s/veh]			2.93	B		
	Intersection LOS				B		

Intersection Level of Service Report
Intersection 2: Second Avenue/North Avenue

Control Type: Two-way stop
 Analysis Method: HCM 6th Edition
 Analysis Period: 15 minutes
 Delay (sec / veh): 9.5
 Level Of Service: A
 Volume to Capacity (v/c): 0.012

Intersection Setup

Name	Second Avenue		Second Avenue		North Ave		North Avenue	
	Northbound	Southbound	Left	Right	Left	Right	Left	Right
Approach	+		+		+		+	
Lane Configuration	+		+		+		+	
Turning Movement	Left	Right	Left	Right	Left	Right	Left	Right
Lane Width [ft]	12.00	12.00	12.00	12.00	12.00	12.00	12.00	12.00
No. of Lanes in Pocket	0	0	0	0	0	0	0	0
Pocket Length [ft]	100.00	100.00	100.00	100.00	100.00	100.00	100.00	100.00
Speed [mph]	40.00		40.00		40.00		40.00	
Grade [%]	0.00		0.00		0.00		0.00	
Crosswalk	No		No		No		No	

Volumes

Name	Second Avenue		Second Avenue		North Ave		North Avenue	
	6	8	9	6	2	21	10	3
Base Volume Input [veh/h]	1,000	1,000	1,000	1,000	1,000	1,000	1,000	1,000
Base Volume Adjustment Factor	1.000	1.000	1.000	1.000	1.000	1.000	1.000	1.000
Heavy Vehicles Percentage [%]	0.00	0.00	0.00	0.00	0.00	10.00	0.00	0.00
Growth Factor	1.1400	1.1400	1.1400	1.1400	1.1400	1.1400	1.1400	1.1400
In-Process Volume [veh/h]	0	0	0	0	0	0	0	0
Site-Generated Trips [veh/h]	0	0	0	0	0	0	0	0
Diverted Trips [veh/h]	0	0	0	0	0	0	0	0
Pass-by Trips [veh/h]	0	0	0	0	0	0	0	0
Existing Site Adjustment Volume [veh/h]	0	0	0	0	0	0	0	0
Other Volume [veh/h]	0	0	0	0	0	0	0	0
Total Hourly Volume [veh/h]	7	9	7	0	10	7	2	24
Peak Hour Factor	1.0000	1.0000	1.0000	1.0000	1.0000	1.0000	1.0000	1.0000
Other Adjustment Factor	1.0000	1.0000	1.0000	1.0000	1.0000	1.0000	1.0000	1.0000
Total 15-Minute Volume [veh/h]	2	2	0	3	2	1	6	3
Total Analysis Volume [veh/h]	7	9	7	0	10	7	2	24
Pedestrian Volume [ped/h]	0	0	0	0	0	0	0	0

Intersection Settings

Priority Scheme	Stop	Stop	Stop	Free
Flared Lane	No	Yes	No	Free
Storage Area [veh]	1	0	0	0
Two-Stage Gap Acceptance	No	No	No	0
Number of Storage Spaces in Median	0	0	0	0

Movement, Approach, & Intersection Results

V/C, Movement V/C Ratio	0.01	0.01	0.01	0.01	0.01	0.01	0.01	0.00	0.00	0.00	0.00
d_M, Delay for Movement [s/veh]	9.09	9.47	8.48	9.11	9.52	8.53	7.27	7.27	7.27	7.27	7.27
Movement LOS	A	A	A	A	A	A	A	A	A	A	A
95th-Percentile Queue Length [veh/ln]	0.06	0.06	0.06	0.06	0.06	0.06	0.06	0.06	0.06	0.06	0.06
95th-Percentile Queue Length [ft/ln]	1.44	1.44	1.44	1.46	1.46	1.46	1.46	1.46	1.46	1.46	1.46
d_A, Approach Delay [s/veh]	9.05										
Approach LOS	A										
d_I, Intersection Delay [s/veh]	3.44										
Intersection LOS	A										

Intersection Level Of Service Report

Control Type: Two-way stop
 Analysis Method: HCM 6th Edition
 Analysis Period: 15 minutes
 Delay (sec / veh): 12.2
 Level Of Service: B
 Volume to Capacity (v/c): 0.063

Intersection Setup

Name	First Ave	Coombsville Rd	Coombsville Rd
Approach	Southbound	Eastbound	Westbound
Lane Configuration	T	T	T
Turning Movement	Left Right	Left Thru Right	Thru Right
Lane Width [ft]	12.00 12.00	12.00 12.00	12.00 12.00
No. of Lanes in Pocket	0 0	0 0	0 0
Pocket Length [ft]	100.00 100.00	100.00 100.00	100.00 100.00
Speed [mph]	40.00	40.00	40.00
Grade [%]	0.00	0.00	0.00
Crosswalk	No	Yes	No

Volumes

Name	First Ave	Coombsville Rd	Coombsville Rd
Base Volume Input [veh/h]	31	61	125
Base Volume Adjustment Factor	1.0000	1.0000	1.0000
Heavy Vehicles Percentage [%]	0.00	2.00	1.00
Growth Factor	1.1400	1.1400	1.1400
In-Process Volume [veh/h]	0	0	0
Site-Generated Trips [veh/h]	0	0	0
Diverted Trips [veh/h]	0	0	0
Pass-by Trips [veh/h]	0	0	0
Existing Site Adjustment Volume [veh/h]	0	0	0
Other Volume [veh/h]	0	0	0
Total Hourly Volume [veh/h]	35	70	143
Peak Hour Factor	1.0000	1.0000	1.0000
Other Adjustment Factor	1.0000	1.0000	1.0000
Total 15-Minute Volume [veh/h]	9	18	36
Total Analysis Volume [veh/h]	35	70	143
Pedestrian Volume [ped/h]	0	1	0

Intersection Settings

Priority Scheme	Stop	Free	Free
Flared Lane	No		
Storage Area [veh]	0	0	0
Two-Stage Gap Acceptance	No		
Number of Storage Spaces in Median	0	0	0

Movement, Approach, & Intersection Results

V/C, Movement V/C Ratio	0.06	0.07	0.05	0.00	0.00
d_M, Delay for Movement [s/veh]	12.25	9.82	7.71	0.00	0.00
Movement LOS	B	A	A	A	A
95th-Percentile Queue Length [veh/ln]	0.46	0.46	0.16	0.16	0.00
95th-Percentile Queue Length [ft/ln]	11.54	11.54	3.95	3.95	0.00
d_A, Approach Delay [s/veh]	10.69		2.73		0.00
Approach LOS	B		A		A
d_I, Intersection Delay [s/veh]			3.34		B
Intersection LOS					

Intersection Level Of Service Report
Intersection 4: Second Avenue/Coombsville Road

Control Type: Two-way stop
Analysis Method: HCM 6th Edition
Analysis Period: 15 minutes
Delay (sec / veh): 10.4
Level Of Service: B
Volume to Capacity (v/c): 0.010

Intersection Setup

Name	Second Avenue	Coombsville Rd	Coombsville Rd
Approach	Southbound	Eastbound	Westbound
Lane Configuration	T	T	T
Turning Movement	Left Right	Left Thru Right	Thru Right
Lane Width [ft]	12.00 12.00	12.00 12.00	12.00 12.00
No. of Lanes in Pocket	0 0	0 0	0 0
Pocket Length [ft]	100.00 100.00	100.00 100.00	100.00 100.00
Speed [mph]	40.00	40.00	40.00
Grade [%]	0.00	0.00	0.00
Crosswalk	No	Yes	No

Volumes

Name	Second Avenue	Coombsville Rd	Coombsville Rd
Base Volume Input [veh/h]	6 24	18 114	122 4
Base Volume Adjustment Factor	1.0000 1.0000	1.0000 1.0000	1.0000 1.0000
Heavy Vehicles Percentage [%]	0.00 0.00	1.00 0.00	0.00 0.00
Growth Factor	1.1400 1.1400	1.1400 1.1400	1.1400 1.1400
In-Process Volume [veh/h]	0 0	0 0	0 0
Site-Generated Trips [veh/h]	0 0	0 0	0 0
Diverted Trips [veh/h]	0 0	0 0	0 0
Pass-by Trips [veh/h]	0 0	0 0	0 0
Existing Site Adjustment Volume [veh/h]	0 0	0 0	0 0
Other Volume [veh/h]	0 0	0 0	0 0
Total Hourly Volume [veh/h]	7 27	21 130	139 5
Peak Hour Factor	1.0000 1.0000	1.0000 1.0000	1.0000 1.0000
Other Adjustment Factor	1.0000 1.0000	1.0000 1.0000	1.0000 1.0000
Total 15-Minute Volume [veh/h]	2 7	5 33	35 1
Total Analysis Volume [veh/h]	7 27	21 130	139 5
Pedestrian Volume [ped/h]	0 0	0 0	0 0

Intersection Settings

Priority Scheme	Stop	Free	Free
Flared Lane	Yes		
Storage Area [veh]	1	0	0
Two-Stage Gap Acceptance	No		
Number of Storage Spaces in Median	0	0	0

Movement, Approach, & Intersection Results

V/C, Movement V/C Ratio	0.01	0.03	0.01	0.00	0.00	0.00
d_M, Delay for Movement [s/veh]	10.45	9.04	7.52	0.00	0.00	0.00
Movement LOS	B	A	A	A	A	A
95th-Percentile Queue Length [veh/ln]	0.09	0.09	0.04	0.04	0.00	0.00
95th-Percentile Queue Length [ft/ln]	2.29	2.29	1.10	1.10	0.00	0.00
d_A, Approach Delay [s/veh]	9.33		1.05			
Approach LOS	A		A			
d_I, Intersection Delay [s/veh]			1.44			
Intersection LOS			B			

Intersection Level Of Service Report

Control Type: Two-way stop
 Analysis Method: HCM 6th Edition
 Analysis Period: 15 minutes
 Delay (sec / veh): 9.5
 Level Of Service: A
 Volume to Capacity (v/c): 0.017

Intersection Setup

Name	First Ave	First Ave	North Ave
Approach	Northbound	Southbound	Westbound
Lane Configuration	Thru Right	Thru Left	Right
Turning Movement	12.00	12.00	12.00
Lane Width [ft]	0	0	0
No. of Lanes in Pocket	100.00	100.00	100.00
Pocket Length [ft]	40.00	40.00	40.00
Speed [mph]	0.00	0.00	0.00
Grade [%]	No	No	No
Crosswalk			

Volumes

Name	First Ave	First Ave	North Ave
Base Volume Input [veh/h]	41	40	23
Base Volume Adjustment Factor	1.0000	1.0000	1.0000
Heavy Vehicles Percentage [%]	0.00	0.00	0.00
Growth Factor	1.1400	1.1400	1.1400
In-Process Volume [veh/h]	0	0	0
Site-Generated Trips [veh/h]	0	0	0
Diverted Trips [veh/h]	0	0	0
Pass-by Trips [veh/h]	0	0	0
Existing Site Adjustment Volume [veh/h]	0	0	0
Other Volume [veh/h]	0	0	0
Total Hourly Volume [veh/h]	47	46	26
Peak Hour Factor	1.0000	1.0000	1.0000
Other Adjustment Factor	1.0000	1.0000	1.0000
Total 15-Minute Volume [veh/h]	12	12	4
Total Analysis Volume [veh/h]	47	46	26
Pedestrian Volume [ped/h]	0	0	0

Intersection Settings

Priority Scheme	Free	Free	Stop
Flared Lane			No
Storage Area [veh]	0	0	0
Two-Stage Gap Acceptance			No
Number of Storage Spaces in Median	0	0	0

Movement, Approach, & Intersection Results

V/C Movement V/C Ratio	0.00	0.00	0.02	0.00	0.02	0.02	0.03
d_M Delay for Movement [s/veh]	0.00	0.00	7.34	0.00	948	8.68	8.68
Movement LOS	A	A	A	A	A	A	A
95th-Percentile Queue Length [veh/ln]	0.00	0.00	0.05	0.05	0.13	0.13	0.13
95th-Percentile Queue Length [ft/ln]	0.00	0.00	1.27	1.27	3.30	3.30	3.30
d_A Approach Delay [s/veh]	0.00	0.00	2.65	A	8.96	8.96	8.96
Approach LOS	A	A	A	A	A	A	A
d_I Intersection Delay [s/veh]			3.35	A			
Intersection LOS			A				

Intersection Level of Service Report
Intersection 2: Second Avenue/North Avenue

Control Type: Two-way stop
Analysis Method: HCM 6th Edition
Analysis Period: 15 minutes

Delay (sec / veh): 9.4
Level Of Service: A
Volume to Capacity (v/c): 0.010

Intersection Setup

Name	Second Avenue		Second Avenue		North Ave		North Avenue	
	Northbound	Southbound	Eastbound	Westbound	Eastbound	Westbound	Eastbound	Westbound
Approach	+		+		+		+	
Lane Configuration	+		+		+		+	
Turning Movement	Left	Right	Left	Right	Left	Right	Left	Right
Lane Width [ft]	12.00	12.00	12.00	12.00	12.00	12.00	12.00	12.00
No. of Lanes in Pocket	0	0	0	0	0	0	0	0
Pocket Length [ft]	100.00	100.00	100.00	100.00	100.00	100.00	100.00	100.00
Speed [mph]	40.00		40.00		40.00		40.00	
Grade [%]	0.00		0.00		0.00		0.00	
Crosswalk	No		No		No		No	

Volumes

Name	Second Avenue		Second Avenue		North Ave		North Avenue	
	2	4	1	7	4	5	11	5
Base Volume Input [veh/h]	1,000	1,000	1,000	1,000	1,000	1,000	1,000	1,000
Base Volume Adjustment Factor	1.000	1.000	1.000	1.000	1.000	1.000	1.000	1.000
Heavy Vehicles Percentage [%]	0.00	0.00	0.00	0.00	0.00	0.00	0.00	0.00
Growth Factor	1.1400	1.1400	1.1400	1.1400	1.1400	1.1400	1.1400	1.1400
In-Process Volume [veh/h]	0	0	0	0	0	0	0	0
Site-Generated Trips [veh/h]	0	0	0	0	0	0	0	0
Diverted Trips [veh/h]	0	0	0	0	0	0	0	0
Pass-by Trips [veh/h]	0	0	0	0	0	0	0	0
Existing Site Adjustment Volume [veh/h]	0	0	0	0	0	0	0	0
Other Volume [veh/h]	0	0	0	0	0	0	0	0
Total Hourly Volume [veh/h]	2	5	2	1	8	5	6	13
Peak Hour Factor	1.0000	1.0000	1.0000	1.0000	1.0000	1.0000	1.0000	1.0000
Other Adjustment Factor	1.0000	1.0000	1.0000	1.0000	1.0000	1.0000	1.0000	1.0000
Total 15-Minute Volume [veh/h]	1	1	1	0	2	1	2	3
Total Analysis Volume [veh/h]	2	5	2	1	8	5	6	13
Pedestrian Volume [ped/h]	0	0	0	0	0	0	0	0



Intersection Settings

Priority Scheme	Stop	Stop	Stop	Free
Flared Lane	Yes			
Storage Area [veh]	1	0	0	0
Two-Stage Gap Acceptance	No	No	No	
Number of Storage Spaces in Median	0	0	0	0

Movement, Approach, & Intersection Results

V/C, Movement V/C Ratio	0.00		0.01		0.00		0.01		0.00		0.00		0.00		0.00	
	d_M, Delay for Movement [s/veh]	8.90	9.31	8.39	8.90	9.37	8.43	9.37	8.43	9.37	8.43	9.37	8.43	9.37	8.43	9.37
Movement LOS	A	A	A	A	A	A	A	A	A	A	A	A	A	A	A	A
95th-Percentile Queue Length [veh/ln]	0.02	0.02	0.02	0.02	0.05	0.05	0.05	0.05	0.01	0.01	0.01	0.01	0.01	0.01	0.01	0.01
95th-Percentile Queue Length [ft/ln]	0.61	0.61	0.61	0.61	1.17	1.17	1.17	1.17	0.28	0.28	0.28	0.28	0.28	0.28	0.28	0.28
d_A, Approach Delay [s/veh]	9.02		9.02		9.00		9.00		1.74		1.74		1.74		1.09	
Approach LOS	A		A		A		A		A		A		A		A	
d_I, Intersection Delay [s/veh]	4.00		4.00		4.00		4.00		4.00		4.00		4.00		4.00	
Intersection LOS	A		A		A		A		A		A		A		A	



Intersection Level Of Service Report

Control Type: Two-way stop
 Analysis Method: HCM 6th Edition
 Analysis Period: 15 minutes

Delay (sec / veh): 10.6
 Level Of Service: B
 Volume to Capacity (v/c): 0.032

Intersection Setup

Name	First Ave	Coombsville Rd	Coombsville Rd
Approach	Southbound	Eastbound	Westbound
Lane Configuration	T	T	T
Turning Movement	Left Right	Left Thru Right	Thru Right
Lane Width [ft]	12.00 12.00	12.00 12.00	12.00 12.00
No. of Lanes in Pocket	0 0	0 0	0 0
Pocket Length [ft]	100.00 100.00	100.00 100.00	100.00 100.00
Speed [mph]	40.00	40.00	40.00
Grade [%]	0.00	0.00	0.00
Crosswalk	No	Yes	No

Volumes

Name	First Ave	Coombsville Rd	Coombsville Rd
Base Volume Input [veh/h]	19	34	71
Base Volume Adjustment Factor	1.0000	1.0000	1.0000
Heavy Vehicles Percentage [%]	0.00	0.00	1.00
Growth Factor	1.1400	1.1400	1.1400
In-Process Volume [veh/h]	0	0	0
Site-Generated Trips [veh/h]	0	0	0
Diverted Trips [veh/h]	0	0	0
Pass-by Trips [veh/h]	0	0	0
Existing Site Adjustment Volume [veh/h]	0	0	0
Other Volume [veh/h]	0	0	0
Total Hourly Volume [veh/h]	22	39	81
Peak Hour Factor	1.0000	1.0000	1.0000
Other Adjustment Factor	1.0000	1.0000	1.0000
Total 15-Minute Volume [veh/h]	6	12	20
Total Analysis Volume [veh/h]	22	39	81
Pedestrian Volume [ped/h]	0	0	0

Intersection Settings

Priority Scheme	Stop	Free	Free
Flared Lane	No		
Storage Area [veh]	0	0	0
Two-Stage Gap Acceptance	No		
Number of Storage Spaces in Median	0	0	0

Movement, Approach, & Intersection Results

V/C, Movement V/C Ratio	0.03	0.05	0.03	0.03	0.00	0.00
d_M, Delay for Movement [s/veh]	10.55	9.22	7.52	0.00	0.00	0.00
Movement LOS	B	A	A	A	A	A
95th-Percentile Queue Length [veh/ln]	0.27	0.27	0.08	0.08	0.00	0.00
95th-Percentile Queue Length [ft/ln]	6.65	6.65	2.05	2.05	0.00	0.00
d_A, Approach Delay [s/veh]	9.64		2.44			
Approach LOS	A		A			
d_I, Intersection Delay [s/veh]			3.00			
Intersection LOS			B			

Intersection Level Of Service Report
Intersection 4: Second Avenue/Coombsville Road

Control Type: Two-way stop
 Analysis Method: HCM 6th Edition
 Analysis Period: 15 minutes
 Delay (sec / veh): 9.7
 Level Of Service: A
 Volume to Capacity (v/c): 0.008

Intersection Setup

Name	Second Avenue	Coombsville Rd	Coombsville Rd
Approach	Southbound	Eastbound	Westbound
Lane Configuration	T	T	T
Turning Movement	Left Right	Left Thru Right	Thru Right
Lane Width [ft]	12.00 12.00	12.00 12.00	12.00 12.00
No. of Lanes in Pocket	0 0	0 0	0 0
Pocket Length [ft]	100.00 100.00	100.00 100.00	100.00 100.00
Speed [mph]	40.00	40.00	40.00
Grade [%]	0.00	0.00	0.00
Crosswalk	No	Yes	No

Volumes

Name	Second Avenue	Coombsville Rd	Coombsville Rd
Base Volume Input [veh/h]	5 13	11 73	92 3
Base Volume Adjustment Factor	1.0000 1.0000	1.0000 1.0000	1.0000 1.0000
Heavy Vehicles Percentage [%]	0.00 0.00	1.00 1.00	1.00 0.00
Growth Factor	1.1400 1.1400	1.1400 1.1400	1.1400 1.1400
In-Process Volume [veh/h]	0 0	0 0	0 0
Site-Generated Trips [veh/h]	0 0	0 0	0 0
Diverted Trips [veh/h]	0 0	0 0	0 0
Pass-by Trips [veh/h]	0 0	0 0	0 0
Existing Site Adjustment Volume [veh/h]	0 0	0 0	0 0
Other Volume [veh/h]	0 0	0 0	0 0
Total Hourly Volume [veh/h]	6 15	13 83	105 3
Peak Hour Factor	1.0000 1.0000	1.0000 1.0000	1.0000 1.0000
Other Adjustment Factor	1.0000 1.0000	1.0000 1.0000	1.0000 1.0000
Total 15-Minute Volume [veh/h]	2 4	3 21	26 1
Total Analysis Volume [veh/h]	6 15	13 83	105 3
Pedestrian Volume [ped/h]	0 0	0 0	0 0

Intersection Settings

Priority Scheme	Stop	Free	Free
Flared Lane	Yes		
Storage Area [veh]	1	0	0
Two-Stage Gap Acceptance	No		
Number of Storage Spaces in Median	0	0	0

Movement, Approach, & Intersection Results

V/C, Movement V/C Ratio	0.01	0.02	0.01	0.00	0.00	0.00
d_M, Delay for Movement [s/veh]	9.72	8.82	7.43	0.00	0.00	0.00
Movement LOS	A	A	A	A	A	A
95th-Percentile Queue Length [veh/ln]	0.05	0.05	0.03	0.03	0.00	0.00
95th-Percentile Queue Length [ft/ln]	1.20	1.20	0.66	0.66	0.00	0.00
d_A, Approach Delay [s/veh]	9.08		1.01			
Approach LOS	A		A			
d_I, Intersection Delay [s/veh]			1.28			
Intersection LOS			A			

Intersection Level Of Service Report

Control Type: Two-way stop
 Analysis Method: HCM 6th Edition
 Analysis Period: 15 minutes

Delay (sec / veh): 10.4
 Level Of Service: B
 Volume to Capacity (v/c): 0.011

Intersection Setup

Name	First Ave	First Ave	North Ave
Approach	Northbound	Southbound	Westbound
Lane Configuration	→	←	→
Turning Movement	Thru 12.00 0	Right 12.00 0	Left 12.00 0
Lane Width [ft]	12.00	12.00	12.00
No. of Lanes in Pocket	0	0	0
Pocket Length [ft]	100.00	100.00	100.00
Speed [mph]	40.00	40.00	40.00
Grade [%]	0.00	0.00	0.00
Crosswalk	No	No	No

Volumes

Name	First Ave	First Ave	North Ave
Base Volume Input [veh/h]	76	33	7
Base Volume Adjustment Factor	1.0000	1.0000	1.0000
Heavy Vehicles Percentage [%]	0.00	3.00	0.00
Growth Factor	1.0000	1.0000	1.0000
In-Process Volume [veh/h]	0	0	0
Site-Generated Trips [veh/h]	0	2	0
Diverted Trips [veh/h]	0	0	0
Pass-by Trips [veh/h]	0	0	0
Existing Site Adjustment Volume [veh/h]	0	0	0
Other Volume [veh/h]	0	0	0
Total Hourly Volume [veh/h]	76	35	7
Peak Hour Factor	0.8300	0.8300	0.8300
Other Adjustment Factor	1.0000	1.0000	1.0000
Total 15-Minute Volume [veh/h]	23	11	2
Total Analysis Volume [veh/h]	92	42	8
Pedestrian Volume [ped/h]	0	0	0

Intersection Settings

Priority Scheme	Free	Free	Stop
Flared Lane			No
Storage Area [veh]	0	0	0
Two-Stage Gap Acceptance			No
Number of Storage Spaces in Median	0	0	0

Movement, Approach, & Intersection Results

V/C, Movement V/C Ratio	0.00	0.00	0.03	0.00	0.01	0.05
d_M, Delay for Movement [s/veh]	0.00	0.00	7.48	0.00	10.38	8.99
Movement LOS	A	A	A	A	B	A
95th-Percentile Queue Length [veh/ln]	0.00	0.00	0.09	0.09	0.21	0.21
95th-Percentile Queue Length [ft/ln]	0.00	0.00	2.17	2.17	5.29	5.29
d_A, Approach Delay [s/veh]	0.00	0.00	2.42	0.00	9.17	9.17
Approach LOS	A	A	A	A	A	A
d_I, Intersection Delay [s/veh]			3.05			
Intersection LOS			B			

Intersection Level of Service Report
Intersection 2: Second Avenue/North Avenue

Control Type: Two-way stop
 Analysis Method: HCM 6th Edition
 Analysis Period: 15 minutes
 Delay (sec / veh): 9.6
 Level Of Service: A
 Volume to Capacity (v/c): 0.021

Intersection Setup

Name	Second Avenue		Second Avenue		North Ave		North Avenue		
	Northbound	Southbound	Eastbound	Westbound	Eastbound	Westbound	Eastbound	Westbound	
Approach	+		+		+		+		
Lane Configuration	+		+		+		+		
Turning Movement	Left	Thru	Right	Left	Thru	Right	Left	Thru	Right
Lane Width [ft]	12.00	12.00	12.00	12.00	12.00	12.00	12.00	12.00	12.00
No. of Lanes in Pocket	0	0	0	0	0	0	0	0	0
Pocket Length [ft]	100.00	100.00	100.00	100.00	100.00	100.00	100.00	100.00	100.00
Speed [mph]	40.00		40.00		40.00		40.00		
Grade [%]	0.00		0.00		0.00		0.00		
Crosswalk	No		No		No		No		

Volumes

Name	Second Avenue		Second Avenue		North Ave		North Avenue			
	6	8	6	9	2	21	10	3	31	1
Base Volume Input [veh/h]	1,000	1,000	1,000	1,000	1,000	1,000	1,000	1,000	1,000	1,000
Base Volume Adjustment Factor	1.000	1.000	1.000	1.000	1.000	1.000	1.000	1.000	1.000	1.000
Heavy Vehicles Percentage [%]	0.00	0.00	0.00	0.00	0.00	0.00	10.00	0.00	0.00	0.00
Growth Factor	1.000	1.000	1.000	1.000	1.000	1.000	1.000	1.000	1.000	1.000
In-Process Volume [veh/h]	0	0	0	0	0	0	0	0	0	0
Site-Generated Trips [veh/h]	0	4	0	1	6	4	2	0	0	0
Diverted Trips [veh/h]	0	0	0	0	0	0	0	0	0	0
Pass-by Trips [veh/h]	0	0	0	0	0	0	0	0	0	0
Existing Site Adjustment Volume [veh/h]	0	0	0	0	0	0	0	0	0	0
Other Volume [veh/h]	0	0	0	0	0	0	0	0	0	0
Total Hourly Volume [veh/h]	6	12	6	1	15	10	4	21	10	3
Peak Hour Factor	0.8900	0.8900	0.8900	0.8900	0.8900	0.8900	0.8900	0.8900	0.8900	0.8900
Other Adjustment Factor	1.0000	1.0000	1.0000	1.0000	1.0000	1.0000	1.0000	1.0000	1.0000	1.0000
Total 15-Minute Volume [veh/h]	2	3	2	0	4	3	1	6	3	1
Total Analysis Volume [veh/h]	7	13	7	1	17	11	4	24	11	3
Pedestrian Volume [ped/h]	0	0	0	0	0	0	0	0	0	0



Intersection Settings

Priority Scheme	Stop	Stop	Stop	Stop	Free
Flared Lane	Yes	Yes	No	No	Free
Storage Area [veh]	1	0	0	0	0
Two-Stage Gap Acceptance	No	No	No	No	0
Number of Storage Spaces in Median	0	0	0	0	0

Movement, Approach, & Intersection Results

V/C, Movement V/C Ratio	0.01	0.02	0.01	0.00	0.02	0.01	0.00	0.00	0.00	0.00	0.00	
d_M, Delay for Movement [s/veh]	9.22	9.52	8.50	9.22	9.61	8.59	7.27	7.27	7.27	7.27	7.27	
Movement LOS	A	A	A	A	A	A	A	A	A	A	A	
95th-Percentile Queue Length [veh/ln]	0.07	0.07	0.07	0.10	0.10	0.10	0.01	0.01	0.01	0.01	0.01	
95th-Percentile Queue Length [ft/ln]	1.85	1.85	1.85	2.54	2.54	2.54	0.19	0.19	0.19	0.19	0.14	
d_A, Approach Delay [s/veh]	9.18		9.21		9.21		0.75		0.75		0.56	
Approach LOS	A		A		A		A		A		A	
d_I, Intersection Delay [s/veh]	4.22		4.22		4.22		A		A		A	
Intersection LOS	A		A		A		A		A		A	



Intersection Level Of Service Report

Control Type: Two-way stop
 Analysis Method: HCM 6th Edition
 Analysis Period: 15 minutes

Delay (sec / veh): 12.3
 Level Of Service: B
 Volume to Capacity (v/c): 0.063

Intersection Setup

Name	First Ave	Coombsville Rd	Coombsville Rd
Approach	Southbound	Eastbound	Westbound
Lane Configuration	T	T	T
Turning Movement	Left Right	Left Thru Right	Thru Right
Lane Width [ft]	12.00	12.00	12.00
No. of Lanes in Pocket	0	0	0
Pocket Length [ft]	100.00	100.00	100.00
Speed [mph]	40.00	40.00	40.00
Grade [%]	0.00	0.00	0.00
Crosswalk	No	Yes	No

Volumes

Name	First Ave	Coombsville Rd	Coombsville Rd
Base Volume Input [veh/h]	31	61	125
Base Volume Adjustment Factor	1.0000	1.0000	1.0000
Heavy Vehicles Percentage [%]	0.00	2.00	1.00
Growth Factor	1.0000	1.0000	1.0000
In-Process Volume [veh/h]	0	0	0
Site-Generated Trips [veh/h]	0	0	5
Diverted Trips [veh/h]	0	0	0
Pass-by Trips [veh/h]	0	0	0
Existing Site Adjustment Volume [veh/h]	0	0	0
Other Volume [veh/h]	0	0	0
Total Hourly Volume [veh/h]	31	61	130
Peak Hour Factor	0.8900	0.8900	0.8900
Other Adjustment Factor	1.0000	1.0000	1.0000
Total 15-Minute Volume [veh/h]	9	17	37
Total Analysis Volume [veh/h]	35	62	146
Pedestrian Volume [ped/h]	0	1	0

Intersection Settings

Priority Scheme	Stop	Free	Free
Flared Lane	No		
Storage Area [veh]	0	0	0
Two-Stage Gap Acceptance	No		
Number of Storage Spaces in Median	0	0	0

Movement, Approach, & Intersection Results

V/C, Movement V/C Ratio	0.06	0.07	0.05	0.00	0.00
d_M, Delay for Movement [s/veh]	12.26	9.83	7.72	0.00	0.00
Movement LOS	B	A	A	A	A
95th-Percentile Queue Length [veh/ln]	0.46	0.46	0.16	0.00	0.00
95th-Percentile Queue Length [ft/ln]	11.47	11.47	3.90	0.00	0.00
d_A, Approach Delay [s/veh]			2.69		
Approach LOS		B	A		A
d_I, Intersection Delay [s/veh]			3.29		
Intersection LOS			B		

Intersection Level Of Service Report
Intersection 4: Second Avenue/Coombsville Road

Control Type: Two-way stop
 Analysis Method: HCM 6th Edition
 Analysis Period: 15 minutes
 Delay (sec / veh): 10.4
 Level Of Service: B
 Volume to Capacity (v/c): 0.010

Intersection Setup

Name	Second Avenue	Coombsville Rd	Coombsville Rd
Approach	Southbound	Eastbound	Westbound
Lane Configuration	T	T	T
Turning Movement	Left Right	Left Thru Right	Thru Right
Lane Width [ft]	12.00 12.00	12.00 12.00	12.00 12.00
No. of Lanes in Pocket	0 0	0 0	0 0
Pocket Length [ft]	100.00 100.00	100.00 100.00	100.00 100.00
Speed [mph]	40.00	40.00	40.00
Grade [%]	0.00	0.00	0.00
Crosswalk	No	Yes	No

Volumes

Name	Second Avenue	Coombsville Rd	Coombsville Rd
Base Volume Input [veh/h]	6 24	18 114	122 4
Base Volume Adjustment Factor	1.0000 1.0000	1.0000 1.0000	1.0000 1.0000
Heavy Vehicles Percentage [%]	0.00 0.00	0.00 1.00	0.00 0.00
Growth Factor	1.0000 1.0000	1.0000 1.0000	1.0000 1.0000
In-Process Volume [veh/h]	0 0	0 0	0 0
Site-Generated Trips [veh/h]	1 5	3 0	0 1
Diverted Trips [veh/h]	0 0	0 0	0 0
Pass-by Trips [veh/h]	0 0	0 0	0 0
Existing Site Adjustment Volume [veh/h]	0 0	0 0	0 0
Other Volume [veh/h]	0 0	0 0	0 0
Total Hourly Volume [veh/h]	7 29	21 114	122 5
Peak Hour Factor	0.9400 0.9400	0.9400 0.9400	0.9400 0.9400
Other Adjustment Factor	1.0000 1.0000	1.0000 1.0000	1.0000 1.0000
Total 15-Minute Volume [veh/h]	2 8	6 30	32 1
Total Analysis Volume [veh/h]	7 31	22 121	130 5
Pedestrian Volume [ped/h]	0 0	0 0	0 0

Intersection Settings

Priority Scheme	Stop	Free	Free
Flared Lane	Yes		
Storage Area [veh]	1	0	0
Two-Stage Gap Acceptance	No		
Number of Storage Spaces in Median	0	0	0

Movement, Approach, & Intersection Results

V/C, Movement V/C Ratio	0.01	0.03	0.02	0.00	0.00	0.00
d_M, Delay for Movement [s/veh]	10.35	9.01	7.50	0.00	0.00	0.00
Movement LOS	B	A	A	A	A	A
95th-Percentile Queue Length [veh/ln]	0.10	0.10	0.05	0.05	0.00	0.00
95th-Percentile Queue Length [ft/ln]	2.61	2.61	1.15	1.15	0.00	0.00
d_A, Approach Delay [s/veh]	9.26		1.15	1.15	0.00	0.00
Approach LOS	A		A	A	A	A
d_I, Intersection Delay [s/veh]			1.64			
Intersection LOS			B			

Intersection Level Of Service Report

Control Type: Two-way stop
 Analysis Method: HCM 6th Edition
 Analysis Period: 15 minutes
 Delay (sec / veh): 9.5
 Level Of Service: A
 Volume to Capacity (v/c): 0.016

Intersection Setup

Name	First Ave	First Ave	North Ave
Approach	Northbound	Southbound	Westbound
Lane Configuration	Thru	Thru	Right
Turning Movement	Right	Left	Left
Lane Width [ft]	12.00	12.00	12.00
No. of Lanes in Pocket	0	0	0
Pocket Length [ft]	100.00	100.00	100.00
Speed [mph]	40.00	40.00	40.00
Grade [%]	0.00	0.00	0.00
Crosswalk	No	No	No

Volumes

Name	First Ave	First Ave	North Ave
Base Volume Input [veh/h]	41	23	23
Base Volume Adjustment Factor	1.0000	1.0000	1.0000
Heavy Vehicles Percentage [%]	0.00	0.00	0.00
Growth Factor	1.0000	1.0000	1.0000
In-Process Volume [veh/h]	0	0	0
Site-Generated Trips [veh/h]	0	5	4
Diverted Trips [veh/h]	0	0	0
Pass-by Trips [veh/h]	0	0	0
Existing Site Adjustment Volume [veh/h]	0	0	0
Other Volume [veh/h]	0	0	0
Total Hourly Volume [veh/h]	41	28	27
Peak Hour Factor	0.8900	0.8900	0.8900
Other Adjustment Factor	1.0000	1.0000	1.0000
Total 15-Minute Volume [veh/h]	12	8	3
Total Analysis Volume [veh/h]	46	31	45
Pedestrian Volume [ped/h]	0	0	0

Intersection Settings

Priority Scheme	Free	Free	Stop
Flared Lane			No
Storage Area [veh]	0	0	0
Two-Stage Gap Acceptance			No
Number of Storage Spaces in Median	0	0	0

Movement, Approach, & Intersection Results

Movement	V/C Ratio	0.00	0.00	0.02	0.00	0.02	0.02	0.02	0.03
d_M, Delay for Movement [s/veh]	0.00	0.00	0.00	7.34	0.00	9.55	8.68		
Movement LOS	A	A	A	A	A	A	A		
95th-Percentile Queue Length [veh/ln]	0.00	0.00	0.06	0.06	0.14	0.14			
95th-Percentile Queue Length [ft/ln]	0.00	0.00	1.51	1.51	3.53	3.53			
d_A, Approach Delay [s/veh]	0.00	0.00	2.99	2.99	8.94				
Approach LOS	A	A	A	A	A				
d_I, Intersection Delay [s/veh]			3.62	3.62					
Intersection LOS			A	A					

Intersection Level Of Service Report

Control Type: Two-way stop
 Analysis Method: HCM 6th Edition
 Analysis Period: 15 minutes
 Delay (sec / veh): 9.5
 Level Of Service: A
 Volume to Capacity (v/c): 0.021

Intersection Setup

Name	Second Avenue		Second Avenue		North Ave		North Avenue		
	Northbound	Southbound	Eastbound	Westbound	Eastbound	Westbound	Eastbound	Westbound	
Approach	+		+		+		+		
Lane Configuration	+		+		+		+		
Turning Movement	Left	Thru	Right	Left	Thru	Right	Left	Thru	Right
Lane Width [ft]	12.00	12.00	12.00	12.00	12.00	12.00	12.00	12.00	12.00
No. of Lanes in Pocket	0	0	0	0	0	0	0	0	0
Pocket Length [ft]	100.00	100.00	100.00	100.00	100.00	100.00	100.00	100.00	100.00
Speed [mph]	40.00		40.00		40.00		40.00		
Grade [%]	0.00		0.00		0.00		0.00		
Crosswalk	No		No		No		No		

Volumes

Name	Second Avenue		Second Avenue		North Ave		North Avenue				
	2	4	1	7	4	5	11	5	3	15	0
Base Volume Input [veh/h]	1.0000	1.0000	1.0000	1.0000	1.0000	1.0000	1.0000	1.0000	1.0000	1.0000	1.0000
Base Volume Adjustment Factor	0.00	0.00	0.00	0.00	0.00	0.00	0.00	0.00	0.00	0.00	0.00
Heavy Vehicles Percentage [%]	1.0000	1.0000	1.0000	1.0000	1.0000	1.0000	1.0000	1.0000	1.0000	1.0000	1.0000
Growth Factor	0	0	0	0	0	0	0	0	0	0	0
In-Process Volume [veh/h]	0	8	0	1	7	4	5	0	0	0	0
Site-Generated Trips [veh/h]	0	0	0	0	0	0	0	0	0	0	0
Diverted Trips [veh/h]	0	0	0	0	0	0	0	0	0	0	0
Pass-by Trips [veh/h]	0	0	0	0	0	0	0	0	0	0	0
Existing Site Adjustment Volume [veh/h]	0	0	0	0	0	0	0	0	0	0	0
Other Volume [veh/h]	0	0	0	0	0	0	0	0	0	0	0
Total Hourly Volume [veh/h]	2	12	2	2	14	8	10	11	5	3	15
Peak Hour Factor	0.8200	0.8200	0.8200	0.8200	0.8200	0.8200	0.8200	0.8200	0.8200	0.8200	0.8200
Other Adjustment Factor	1.0000	1.0000	1.0000	1.0000	1.0000	1.0000	1.0000	1.0000	1.0000	1.0000	1.0000
Total 15-Minute Volume [veh/h]	1	4	1	1	4	2	3	3	2	1	5
Total Analysis Volume [veh/h]	2	15	2	2	17	10	12	13	6	4	18
Pedestrian Volume [ped/h]	0	0	0	0	0	0	0	0	0	0	0

Intersection Settings

Priority Scheme	Stop	Stop	Stop	Free
Flared Lane	Yes	No	No	Free
Storage Area [veh]	1	0	0	0
Two-Stage Gap Acceptance	No	No	No	0
Number of Storage Spaces in Median	0	0	0	0

Movement, Approach, & Intersection Results

V/C, Movement V/C Ratio	0.00		0.00		0.00		0.01		0.01		0.00		0.00		0.00	
	d_M, Delay for Movement [s/veh]	9.15	9.47	8.45	9.14	9.54	8.51	7.25	7.25	7.25	7.24	7.24	7.24	7.24	7.24	7.24
Movement LOS	A	A	A	A	A	A	A	A	A	A	A	A	A	A	A	A
95th-Percentile Queue Length [veh/ln]	0.06	0.06	0.06	0.10	0.10	0.10	0.02	0.02	0.02	0.02	0.01	0.01	0.01	0.01	0.01	0.01
95th-Percentile Queue Length [ft/ln]	1.57	1.57	1.57	2.51	2.51	2.51	0.56	0.56	0.56	0.56	0.19	0.19	0.19	0.19	0.19	0.19
d_A, Approach Delay [s/veh]	9.33		9.16		9.16		2.81		2.81		1.32		1.32		1.32	
Approach LOS	A		A		A		A		A		A		A		A	
d_I, Intersection Delay [s/veh]	5.53		5.53		5.53		A		A		A		A		A	
Intersection LOS	A		A		A		A		A		A		A		A	

Intersection Level Of Service Report

Control Type: Two-way stop
 Analysis Method: HCM 6th Edition
 Analysis Period: 15 minutes

Delay (sec / veh): 10.6
 Level Of Service: B
 Volume to Capacity (v/c): 0.031

Intersection Setup

Name	First Ave	Coombsville Rd	Coombsville Rd
Approach	Southbound	Eastbound	Westbound
Lane Configuration	T	T	T
Turning Movement	Left Right	Left Thru Right	Thru Right
Lane Width [ft]	12.00	12.00	12.00
No. of Lanes in Pocket	0	0	0
Pocket Length [ft]	100.00	100.00	100.00
Speed [mph]	40.00	40.00	40.00
Grade [%]	0.00	0.00	0.00
Crosswalk	No	Yes	No

Volumes

Name	First Ave	Coombsville Rd	Coombsville Rd
Base Volume Input [veh/h]	19	34	71
Base Volume Adjustment Factor	1.0000	1.0000	1.0000
Heavy Vehicles Percentage [%]	0.00	0.00	1.00
Growth Factor	1.0000	1.0000	1.0000
In-Process Volume [veh/h]	0	0	0
Site-Generated Trips [veh/h]	0	0	7
Diverted Trips [veh/h]	0	0	0
Pass-by Trips [veh/h]	0	0	0
Existing Site Adjustment Volume [veh/h]	0	0	0
Other Volume [veh/h]	0	0	0
Total Hourly Volume [veh/h]	19	34	78
Peak Hour Factor	0.8900	0.8900	0.8900
Other Adjustment Factor	1.0000	1.0000	1.0000
Total 15-Minute Volume [veh/h]	5	12	22
Total Analysis Volume [veh/h]	21	46	86
Pedestrian Volume [ped/h]	0	0	0

Intersection Settings

Priority Scheme	Stop	Free	Free
Flared Lane	No		
Storage Area [veh]	0	0	0
Two-Stage Gap Acceptance	No		
Number of Storage Spaces in Median	0	0	0

Movement, Approach, & Intersection Results

V/C, Movement V/C Ratio	0.03	0.05	0.03	0.03	0.00	0.00
d_M, Delay for Movement [s/veh]	10.61	9.23	7.53	0.00	0.00	0.00
Movement LOS	B	A	A	A	A	A
95th-Percentile Queue Length [veh/ln]	0.26	0.26	0.08	0.08	0.00	0.00
95th-Percentile Queue Length [ft/ln]	6.49	6.49	2.00	2.00	0.00	0.00
d_A, Approach Delay [s/veh]	9.66		2.27			
Approach LOS	A		A			
d_I, Intersection Delay [s/veh]			2.85			
Intersection LOS			B			

Intersection Level Of Service Report
Intersection 4: Second Avenue/Coombsville Road

Control Type: Two-way stop
Analysis Method: HCM 6th Edition
Analysis Period: 15 minutes
Delay (sec / veh): 9.9
Level Of Service: A
Volume to Capacity (v/c): 0.009

Intersection Setup

Name	Second Avenue	Coombsville Rd	Coombsville Rd
Approach	Southbound	Eastbound	Westbound
Lane Configuration	T	T	T
Turning Movement	Left Right	Left Thru Right	Thru Right
Lane Width [ft]	12.00 12.00	12.00 12.00	12.00 12.00
No. of Lanes in Pocket	0 0	0 0	0 0
Pocket Length [ft]	100.00 100.00	100.00 100.00	100.00 100.00
Speed [mph]	40.00	40.00	40.00
Grade [%]	0.00	0.00	0.00
Crosswalk	No	Yes	No

Volumes

Name	Second Avenue	Coombsville Rd	Coombsville Rd
Base Volume Input [veh/h]	5 13	11 73	92 3
Base Volume Adjustment Factor	1.0000 1.0000	1.0000 1.0000	1.0000 1.0000
Heavy Vehicles Percentage [%]	0.00 0.00	1.00 1.00	1.00 0.00
Growth Factor	1.0000 1.0000	1.0000 1.0000	1.0000 1.0000
In-Process Volume [veh/h]	0 0	0 0	0 0
Site-Generated Trips [veh/h]	1 6	7 0	0 1
Diverted Trips [veh/h]	0 0	0 0	0 0
Pass-by Trips [veh/h]	0 0	0 0	0 0
Existing Site Adjustment Volume [veh/h]	0 0	0 0	0 0
Other Volume [veh/h]	0 0	0 0	0 0
Total Hourly Volume [veh/h]	6 19	18 73	92 4
Peak Hour Factor	0.8800 0.8800	0.8800 0.8800	0.8800 0.8800
Other Adjustment Factor	1.0000 1.0000	1.0000 1.0000	1.0000 1.0000
Total 15-Minute Volume [veh/h]	2 5	5 21	26 1
Total Analysis Volume [veh/h]	7 22	20 83	105 5
Pedestrian Volume [ped/h]	0 0	0 0	0 0

Intersection Settings

Priority Scheme	Stop	Free	Free
Flared Lane	Yes		
Storage Area [veh]	1	0	0
Two-Stage Gap Acceptance	No		
Number of Storage Spaces in Median	0	0	0

Movement, Approach, & Intersection Results

V/C, Movement V/C Ratio	0.01	0.02	0.01	0.00	0.00	0.00
d_M, Delay for Movement [s/veh]	9.86	8.85	7.44	0.00	0.00	0.00
Movement LOS	A	A	A	A	A	A
95th-Percentile Queue Length [veh/ln]	0.07	0.07	0.04	0.04	0.00	0.00
95th-Percentile Queue Length [ft/ln]	1.77	1.77	1.02	1.02	0.00	0.00
d_A, Approach Delay [s/veh]	9.09		1.45			
Approach LOS	A		A			
d_I, Intersection Delay [s/veh]			1.70			
Intersection LOS			A			

Intersection Level Of Service Report

Control Type: Two-way stop
 Analysis Method: HCM 6th Edition
 Analysis Period: 15 minutes

Delay (sec / veh): 10.3
 Level Of Service: B
 Volume to Capacity (v/c): 0.011

Intersection Setup

Name	First Ave	First Ave	North Ave
Approach	Northbound	Southbound	Westbound
Lane Configuration	Thru	Thru	Right
Turning Movement	Right	Left	Left
Lane Width [ft]	12.00	12.00	12.00
No. of Lanes in Pocket	0	0	0
Pocket Length [ft]	100.00	100.00	100.00
Speed [mph]	40.00	40.00	40.00
Grade [%]	0.00	0.00	0.00
Crosswalk	No	No	No

Volumes

Name	First Ave	First Ave	North Ave
Base Volume Input [veh/h]	76	33	7
Base Volume Adjustment Factor	1.0000	1.0000	1.0000
Heavy Vehicles Percentage [%]	0.00	3.00	0.00
Growth Factor	1.1400	1.1400	1.1400
In-Process Volume [veh/h]	0	0	0
Site-Generated Trips [veh/h]	0	2	0
Diverted Trips [veh/h]	0	0	0
Pass-by Trips [veh/h]	0	0	0
Existing Site Adjustment Volume [veh/h]	0	0	0
Other Volume [veh/h]	0	0	0
Total Hourly Volume [veh/h]	87	40	8
Peak Hour Factor	1.0000	1.0000	1.0000
Other Adjustment Factor	1.0000	1.0000	1.0000
Total 15-Minute Volume [veh/h]	22	10	2
Total Analysis Volume [veh/h]	87	40	8
Pedestrian Volume [ped/h]	0	0	0

Intersection Settings

Priority Scheme	Free	Free	Stop
Flared Lane			No
Storage Area [veh]	0	0	0
Two-Stage Gap Acceptance			No
Number of Storage Spaces in Median	0	0	0

Movement, Approach, & Intersection Results

V/C	Movement V/C Ratio	0.00	0.00	0.03	0.00	0.01	0.05
d_M	Delay for Movement [s/veh]	0.00	0.00	7.47	0.00	10.25	8.95
	Movement LOS	A	A	A	A	B	A
95th-Percentile Queue Length [veh]		0.00	0.00	0.08	0.08	0.20	0.20
95th-Percentile Queue Length [ft]		0.00	0.00	2.06	2.06	4.98	4.98
d_A	Approach Delay [s/veh]	0.00	0.00	2.43	0.00	9.13	
	Approach LOS	A	A	A	A	A	
d_I	Intersection Delay [s/veh]			3.06			
	Intersection LOS			B			

Intersection Level of Service Report
Intersection 2: Second Avenue/North Avenue

Control Type: Two-way stop
Analysis Method: HCM 6th Edition
Analysis Period: 15 minutes

Delay (sec / veh): 9.6
Level Of Service: A
Volume to Capacity (v/c): 0.020

Intersection Setup

Name	Second Avenue		Second Avenue		North Ave		North Avenue	
	Northbound	Southbound	Eastbound	Westbound	Eastbound	Westbound	Eastbound	Westbound
Approach	+		+		+		+	
Lane Configuration	+		+		+		+	
Turning Movement	Left	Right	Left	Right	Left	Right	Left	Right
Lane Width [ft]	12.00	12.00	12.00	12.00	12.00	12.00	12.00	12.00
No. of Lanes in Pocket	0	0	0	0	0	0	0	0
Pocket Length [ft]	100.00	100.00	100.00	100.00	100.00	100.00	100.00	100.00
Speed [mph]	40.00		40.00		40.00		40.00	
Grade [%]	0.00		0.00		0.00		0.00	
Crosswalk	No		No		No		No	

Volumes

Name	Second Avenue		Second Avenue		North Ave		North Avenue	
	6	8	9	6	2	21	10	3
Base Volume Input [veh/h]	1,000	1,000	1,000	1,000	1,000	1,000	1,000	1,000
Base Volume Adjustment Factor	1.000	1.000	1.000	1.000	1.000	1.000	1.000	1.000
Heavy Vehicles Percentage [%]	0.00	0.00	0.00	0.00	0.00	10.00	0.00	0.00
Growth Factor	1.1400	1.1400	1.1400	1.1400	1.1400	1.1400	1.1400	1.1400
In-Process Volume [veh/h]	0	0	0	0	0	0	0	0
Site-Generated Trips [veh/h]	0	4	0	1	6	4	2	0
Diverted Trips [veh/h]	0	0	0	0	0	0	0	0
Pass-by Trips [veh/h]	0	0	0	0	0	0	0	0
Existing Site Adjustment Volume [veh/h]	0	0	0	0	0	0	0	0
Other Volume [veh/h]	0	0	0	0	0	0	0	0
Total Hourly Volume [veh/h]	7	13	7	1	16	11	4	24
Peak Hour Factor	1.0000	1.0000	1.0000	1.0000	1.0000	1.0000	1.0000	1.0000
Other Adjustment Factor	1.0000	1.0000	1.0000	1.0000	1.0000	1.0000	1.0000	1.0000
Total 15-Minute Volume [veh/h]	2	3	2	0	4	3	1	6
Total Analysis Volume [veh/h]	7	13	7	1	16	11	4	24
Pedestrian Volume [ped/h]	0	0	0	0	0	0	0	0



Intersection Settings

Priority Scheme	Stop	Stop	Stop	Free
Flared Lane	Yes	No	No	Free
Storage Area [veh]	1	0	0	0
Two-Stage Gap Acceptance	No	No	No	0
Number of Storage Spaces in Median	0	0	0	0

Movement, Approach, & Intersection Results

V/C, Movement V/C Ratio	0.01	0.02	0.01	0.00	0.02	0.01	0.00	0.00	0.00	0.00	0.00	
d_M, Delay for Movement [s/veh]	9.22	9.52	8.50	9.22	9.60	8.58	7.27	0.00	0.00	7.27	0.00	
Movement LOS	A	A	A	A	A	A	A	A	A	A	A	
95th-Percentile Queue Length [veh/ln]	0.07	0.07	0.07	0.10	0.10	0.10	0.01	0.01	0.01	0.01	0.01	
95th-Percentile Queue Length [ft/ln]	1.85	1.85	1.85	2.44	2.44	2.44	0.19	0.19	0.19	0.14	0.14	
d_A, Approach Delay [s/veh]	9.18		9.19		9.19		0.75		0.56		A	
Approach LOS	A		A		A		A		A		A	
d_I, Intersection Delay [s/veh]	4.18				A				A			
Intersection LOS	A				A				A			



Intersection Level Of Service Report

Control Type: Two-way stop
 Analysis Method: HCM 6th Edition
 Analysis Period: 15 minutes
 Delay (sec / veh): 12.3
 Level Of Service: B
 Volume to Capacity (v/c): 0.064

Intersection Setup

Name	First Ave	Coombsville Rd	Coombsville Rd
Approach	Southbound	Eastbound	Westbound
Lane Configuration	T	T	T
Turning Movement	Left Right	Left Thru Right	Thru Right
Lane Width [ft]	12.00 12.00	12.00 12.00	12.00 12.00
No. of Lanes in Pocket	0 0	0 0	0 0
Pocket Length [ft]	100.00 100.00	100.00 100.00	100.00 100.00
Speed [mph]	40.00	40.00	40.00
Grade [%]	0.00	0.00	0.00
Crosswalk	No	Yes	No

Volumes

Name	First Ave	Coombsville Rd	Coombsville Rd
Base Volume Input [veh/h]	31	55	112
Base Volume Adjustment Factor	1.0000	1.0000	1.0000
Heavy Vehicles Percentage [%]	0.00	2.00	1.00
Growth Factor	1.1400	1.1400	1.1400
In-Process Volume [veh/h]	0	0	0
Site-Generated Trips [veh/h]	0	0	3
Diverted Trips [veh/h]	0	0	0
Pass-by Trips [veh/h]	0	0	0
Existing Site Adjustment Volume [veh/h]	0	0	0
Other Volume [veh/h]	0	0	0
Total Hourly Volume [veh/h]	35	63	131
Peak Hour Factor	1.0000	1.0000	1.0000
Other Adjustment Factor	1.0000	1.0000	1.0000
Total 15-Minute Volume [veh/h]	9	18	33
Total Analysis Volume [veh/h]	35	63	131
Pedestrian Volume [ped/h]	0	0	1

Intersection Settings

Priority Scheme	Stop	Free	Free
Flared Lane	No		
Storage Area [veh]	0	0	0
Two-Stage Gap Acceptance	No		
Number of Storage Spaces in Median	0	0	0

Movement, Approach, & Intersection Results

V/C, Movement V/C Ratio	0.06	0.07	0.05	0.00	0.00
d_M, Delay for Movement [s/veh]	12.33	9.86	7.73	0.00	0.00
Movement LOS	B	A	A	A	A
95th-Percentile Queue Length [veh/ln]	0.47	0.47	0.16	0.16	0.00
95th-Percentile Queue Length [ft/ln]	11.66	11.66	3.97	3.97	0.00
d_A, Approach Delay [s/veh]		10.74	2.69		0.00
Approach LOS		B	A		A
d_I, Intersection Delay [s/veh]			3.30		
Intersection LOS			B		

Intersection Level Of Service Report
Intersection 4: Second Avenue/Coombsville Road

Control Type: Two-way stop
 Analysis Method: HCM 6th Edition
 Analysis Period: 15 minutes
 Delay (sec / veh): 10.5
 Level Of Service: B
 Volume to Capacity (v/c): 0.012

Intersection Setup

Name	Second Avenue	Coombsville Rd	Coombsville Rd
Approach	Southbound	Eastbound	Westbound
Lane Configuration	T	T	T
Turning Movement	Left Right	Left Thru Right	Thru Right
Lane Width [ft]	12.00 12.00	12.00 12.00	12.00 12.00
No. of Lanes in Pocket	0 0	0 0	0 0
Pocket Length [ft]	100.00 100.00	100.00 100.00	100.00 100.00
Speed [mph]	40.00	40.00	40.00
Grade [%]	0.00	0.00	0.00
Crosswalk	No	Yes	No

Volumes

Name	Second Avenue	Coombsville Rd	Coombsville Rd
Base Volume Input [veh/h]	6 24	18 114	122 4
Base Volume Adjustment Factor	1.0000 1.0000	1.0000 1.0000	1.0000 1.0000
Heavy Vehicles Percentage [%]	0.00 0.00	0.00 1.00	0.00 0.00
Growth Factor	1.1400 1.1400	1.1400 1.1400	1.1400 1.1400
In-Process Volume [veh/h]	0 0	0 0	0 0
Site-Generated Trips [veh/h]	1 5	3 0	0 1
Diverted Trips [veh/h]	0 0	0 0	0 0
Pass-by Trips [veh/h]	0 0	0 0	0 0
Existing Site Adjustment Volume [veh/h]	0 0	0 0	0 0
Other Volume [veh/h]	0 0	0 0	0 0
Total Hourly Volume [veh/h]	8 32	24 130	139 6
Peak Hour Factor	1.0000 1.0000	1.0000 1.0000	1.0000 1.0000
Other Adjustment Factor	1.0000 1.0000	1.0000 1.0000	1.0000 1.0000
Total 15-Minute Volume [veh/h]	2 8	6 33	35 2
Total Analysis Volume [veh/h]	8 32	24 130	139 6
Pedestrian Volume [ped/h]	0 0	0 0	0 0

Intersection Settings

Priority Scheme	Stop	Free	Free
Flared Lane	Yes		
Storage Area [veh]	1	0	0
Two-Stage Gap Acceptance	No		
Number of Storage Spaces in Median	0	0	0

Movement, Approach, & Intersection Results

V/C, Movement V/C Ratio	0.01	0.04	0.02	0.00	0.00	0.00
d_M, Delay for Movement [s/veh]	10.62	9.07	7.53	0.00	0.00	0.00
Movement LOS	B	A	A	A	A	A
95th-Percentile Queue Length [veh/ln]	0.11	0.11	0.05	0.05	0.00	0.00
95th-Percentile Queue Length [ft/ln]	2.73	2.73	1.26	1.26	0.00	0.00
d_A, Approach Delay [s/veh]	9.36		1.17			
Approach LOS	A		A			
d_I, Intersection Delay [s/veh]			1.64			
Intersection LOS			B			

Intersection Level Of Service Report

Control Type: Two-way stop
 Analysis Method: HCM 6th Edition
 Analysis Period: 15 minutes
 Delay (sec / veh): 9.6
 Level Of Service: A
 Volume to Capacity (v/c): 0.017

Intersection Setup

Name	First Ave	First Ave	North Ave
Approach	Northbound	Southbound	Westbound
Lane Configuration	Thru	Thru	Right
Turning Movement	Right	Left	Left
Lane Width [ft]	12.00	12.00	12.00
No. of Lanes in Pocket	0	0	0
Pocket Length [ft]	100.00	100.00	100.00
Speed [mph]	40.00	40.00	40.00
Grade [%]	0.00	0.00	0.00
Crosswalk	No	No	No

Volumes

Name	First Ave	First Ave	North Ave
Base Volume Input [veh/h]	41	23	23
Base Volume Adjustment Factor	1.0000	1.0000	1.0000
Heavy Vehicles Percentage [%]	2.00	0.00	0.00
Growth Factor	1.1400	1.1400	1.1400
In-Process Volume [veh/h]	0	0	0
Site-Generated Trips [veh/h]	0	5	4
Diverted Trips [veh/h]	0	0	0
Pass-by Trips [veh/h]	0	0	0
Existing Site Adjustment Volume [veh/h]	0	0	0
Other Volume [veh/h]	0	0	0
Total Hourly Volume [veh/h]	47	31	14
Peak Hour Factor	1.0000	1.0000	1.0000
Other Adjustment Factor	1.0000	1.0000	1.0000
Total 15-Minute Volume [veh/h]	12	8	4
Total Analysis Volume [veh/h]	47	31	14
Pedestrian Volume [ped/h]	0	0	0

Intersection Settings

Priority Scheme	Free	Free	Stop
Flared Lane			No
Storage Area [veh]	0	0	0
Two-Stage Gap Acceptance			No
Number of Storage Spaces in Median	0	0	0

Movement, Approach, & Intersection Results

V/C	Movement V/C Ratio	0.00	0.00	0.02	0.00	0.02	0.02	0.03
d_M	Delay for Movement [s/veh]	0.00	0.00	7.34	0.00	9.57	8.70	8.70
	Movement LOS	A	A	A	A	A	A	A
95th-Percentile Queue Length [veh/ln]		0.00	0.00	0.06	0.06	0.15	0.15	0.15
95th-Percentile Queue Length [ft/ln]		0.00	0.00	1.51	1.51	3.64	3.64	3.64
d_A	Approach Delay [s/veh]	0.00	0.00	2.96	A	8.97	A	8.97
	Approach LOS	A	A	A	A	A	A	A
d_I	Intersection Delay [s/veh]			3.60				
	Intersection LOS			A				

Intersection Level Of Service Report
Intersection 2: Second Avenue/North Avenue

Control Type: Two-way stop
 Analysis Method: HCM 6th Edition
 Analysis Period: 15 minutes
 Delay (sec / veh): 9.5
 Level Of Service: A
 Volume to Capacity (v/c): 0.018

Intersection Setup

Name	Second Avenue		Second Avenue		North Ave		North Avenue		
	Northbound	Southbound	Eastbound	Westbound	Eastbound	Westbound	Eastbound	Westbound	
Approach	+		+		+		+		
Lane Configuration	+		+		+		+		
Turning Movement	Left	Thru	Right	Left	Thru	Right	Left	Thru	Right
Lane Width [ft]	12.00	12.00	12.00	12.00	12.00	12.00	12.00	12.00	12.00
No. of Lanes in Pocket	0	0	0	0	0	0	0	0	0
Pocket Length [ft]	100.00	100.00	100.00	100.00	100.00	100.00	100.00	100.00	100.00
Speed [mph]	40.00		40.00		40.00		40.00		
Grade [%]	0.00		0.00		0.00		0.00		
Crosswalk	No		No		No		No		

Volumes

Name	Second Avenue				North Ave				North Avenue				
	2	4	2	1	7	4	5	11	5	3	15	0	0
Base Volume Input [veh/h]	1,000	1,000	1,000	1,000	1,000	1,000	1,000	1,000	1,000	1,000	1,000	1,000	1,000
Base Volume Adjustment Factor	0.00	0.00	0.00	0.00	0.00	0.00	0.00	0.00	0.00	0.00	0.00	0.00	0.00
Heavy Vehicles Percentage [%]	1,140	1,140	1,140	1,140	1,140	1,140	1,140	1,140	1,140	1,140	1,140	1,140	1,140
Growth Factor	0	0	0	0	0	0	0	0	0	0	0	0	0
In-Process Volume [veh/h]	0	8	0	1	7	4	5	0	0	0	0	0	0
Site-Generated Trips [veh/h]	0	0	0	0	0	0	0	0	0	0	0	0	0
Diverted Trips [veh/h]	0	0	0	0	0	0	0	0	0	0	0	0	0
Pass-by Trips [veh/h]	0	0	0	0	0	0	0	0	0	0	0	0	0
Existing Site Adjustment Volume [veh/h]	0	0	0	0	0	0	0	0	0	0	0	0	0
Other Volume [veh/h]	2	13	2	2	15	9	11	13	6	3	17	0	0
Total Hourly Volume [veh/h]	1,000	1,000	1,000	1,000	1,000	1,000	1,000	1,000	1,000	1,000	1,000	1,000	1,000
Peak Hour Factor	1,000	1,000	1,000	1,000	1,000	1,000	1,000	1,000	1,000	1,000	1,000	1,000	1,000
Other Adjustment Factor	1	3	1	1	4	2	3	3	2	1	4	0	0
Total 15-Minute Volume [veh/h]	2	13	2	2	15	9	11	13	6	3	17	0	0
Total Analysis Volume [veh/h]	0	0	0	0	0	0	0	0	0	0	0	0	0
Pedestrian Volume [ped/h]	0	0	0	0	0	0	0	0	0	0	0	0	0



Intersection Settings

Priority Scheme	Stop	Stop	Stop	Free
Flared Lane	Yes	No	No	Free
Storage Area [veh]	1	0	0	0
Two-Stage Gap Acceptance	No	No	No	0
Number of Storage Spaces in Median	0	0	0	0

Movement, Approach, & Intersection Results

V/C, Movement V/C Ratio	0.00	0.02	0.00	0.00	0.02	0.01	0.01	0.01	0.00	0.00	0.00	0.00	0.00
d_M, Delay for Movement [s/veh]	9.09	9.43	8.44	9.08	9.49	8.49	7.25	7.25	0.00	0.00	7.24	0.00	0.00
Movement LOS	A	A	A	A	A	A	A	A	A	A	A	A	A
95th-Percentile Queue Length [veh/ln]	0.05	0.05	0.05	0.09	0.09	0.09	0.02	0.02	0.02	0.01	0.01	0.01	0.01
95th-Percentile Queue Length [ft/ln]	1.37	1.37	1.37	2.23	2.23	2.23	0.51	0.51	0.51	0.14	0.14	0.14	0.14
d_A, Approach Delay [s/veh]	9.27												
Approach LOS	A												
d_I, Intersection Delay [s/veh]	5.33												
Intersection LOS	A												



Intersection Level Of Service Report

Control Type: Two-way stop
 Analysis Method: HCM 6th Edition
 Analysis Period: 15 minutes
 Delay (sec / veh): 10.6
 Level Of Service: B
 Volume to Capacity (v/c): 0.032

Intersection Setup

Name	First Ave	Coombsville Rd	Coombsville Rd
Approach	Southbound	Eastbound	Westbound
Lane Configuration	T	T	T
Turning Movement	Left Right	Left Thru Right	Thru Right
Lane Width [ft]	12.00	12.00	12.00
No. of Lanes in Pocket	0	0	0
Pocket Length [ft]	100.00	100.00	100.00
Speed [mph]	40.00	40.00	40.00
Grade [%]	0.00	0.00	0.00
Crosswalk	No	Yes	No

Volumes

Name	First Ave	Coombsville Rd	Coombsville Rd
Base Volume Input [veh/h]	19	34	71
Base Volume Adjustment Factor	1.0000	1.0000	1.0000
Heavy Vehicles Percentage [%]	0.00	0.00	1.00
Growth Factor	1.1400	1.1400	1.1400
In-Process Volume [veh/h]	0	0	0
Site-Generated Trips [veh/h]	0	0	7
Diverted Trips [veh/h]	0	0	0
Pass-by Trips [veh/h]	0	0	0
Existing Site Adjustment Volume [veh/h]	0	0	0
Other Volume [veh/h]	0	0	0
Total Hourly Volume [veh/h]	22	39	88
Peak Hour Factor	1.0000	1.0000	1.0000
Other Adjustment Factor	1.0000	1.0000	1.0000
Total 15-Minute Volume [veh/h]	6	12	22
Total Analysis Volume [veh/h]	22	47	88
Pedestrian Volume [ped/h]	0	0	0

Intersection Settings

Priority Scheme	Stop	Free	Free
Flared Lane	No		
Storage Area [veh]	0	0	0
Two-Stage Gap Acceptance	No		
Number of Storage Spaces in Median	0	0	0

Movement, Approach, & Intersection Results

V/C, Movement V/C Ratio	0.03	0.05	0.03	0.03	0.00	0.00
d_M, Delay for Movement [s/veh]	10.65	9.25	7.53	0.00	0.00	0.00
Movement LOS	B	A	A	A	A	A
95th-Percentile Queue Length [veh/ln]	0.27	0.27	0.08	0.08	0.00	0.00
95th-Percentile Queue Length [ft/ln]	6.74	6.74	2.06	2.06	0.00	0.00
d_A, Approach Delay [s/veh]	9.70		2.31			
Approach LOS	A		A			A
d_I, Intersection Delay [s/veh]			2.90			
Intersection LOS			B			

Intersection Level Of Service Report

Control Type: Two-way stop
 Analysis Method: HCM 6th Edition
 Analysis Period: 15 minutes

Delay (sec / veh): 9.9
 Level Of Service: A
 Volume to Capacity (v/c): 0.009

Intersection Setup

Name	Second Avenue	Coombsville Rd	Coombsville Rd
Approach	Southbound	Eastbound	Westbound
Lane Configuration	T	T	T
Turning Movement	Left Right	Left Thru Right	Thru Right
Lane Width [ft]	12.00 12.00	12.00 12.00	12.00 12.00
No. of Lanes in Pocket	0 0	0 0	0 0
Pocket Length [ft]	100.00 100.00	100.00 100.00	100.00 100.00
Speed [mph]	40.00	40.00	40.00
Grade [%]	0.00	0.00	0.00
Crosswalk	No	Yes	No

Volumes

Name	Second Avenue	Coombsville Rd	Coombsville Rd
Base Volume Input [veh/h]	5 13	11 73	92 3
Base Volume Adjustment Factor	1.0000 1.0000	1.0000 1.0000	1.0000 1.0000
Heavy Vehicles Percentage [%]	0.00 0.00	0.00 1.00	1.00 0.00
Growth Factor	1.1400 1.1400	1.1400 1.1400	1.1400 1.1400
In-Process Volume [veh/h]	0 0	0 0	0 0
Site-Generated Trips [veh/h]	1 6	7 0	0 1
Diverted Trips [veh/h]	0 0	0 0	0 0
Pass-by Trips [veh/h]	0 0	0 0	0 0
Existing Site Adjustment Volume [veh/h]	0 0	0 0	0 0
Other Volume [veh/h]	0 0	0 0	0 0
Total Hourly Volume [veh/h]	7 21	20 83	105 4
Peak Hour Factor	1.0000 1.0000	1.0000 1.0000	1.0000 1.0000
Other Adjustment Factor	1.0000 1.0000	1.0000 1.0000	1.0000 1.0000
Total 15-Minute Volume [veh/h]	2 5	5 21	26 1
Total Analysis Volume [veh/h]	7 21	20 83	105 4
Pedestrian Volume [ped/h]	0 0	0 0	0 0

Intersection Settings

Priority Scheme	Stop	Free	Free
Flared Lane	Yes		
Storage Area [veh]	1	0	0
Two-Stage Gap Acceptance	No		
Number of Storage Spaces in Median	0	0	0

Movement, Approach, & Intersection Results

V/C, Movement V/C Ratio	0.01	0.02	0.01	0.00	0.00	0.00
d_M, Delay for Movement [s/veh]	9.85	8.84	7.44	0.00	0.00	0.00
Movement LOS	A	A	A	A	A	A
95th-Percentile Queue Length [veh/ln]	0.07	0.07	0.04	0.04	0.00	0.00
95th-Percentile Queue Length [ft/ln]	1.69	1.69	1.02	1.02	0.00	0.00
d_A, Approach Delay [s/veh]	9.10		1.45			
Approach LOS	A		A			
d_I, Intersection Delay [s/veh]			1.68			
Intersection LOS			A			

Appendix D

Trip Generation Spreadsheets





This page intentionally left blank

Winery Traffic Information / Trip Generation Sheet

Project Name: Rapp Equestrian Center

Project Scenario:

Existing/Proposed

Traffic during a Typical Weekday

Number of FT employees: <u>7</u> x 3.05 one-way trips per employee	=	<u>21</u> daily trips.
Number of PT employees: <u>2</u> x 1.90 one-way trips per employee	=	<u>4</u> daily trips.
Average number of weekday visitors: <u>50</u> / 2.6 visitors per vehicle x 2 one-way trips	=	<u>38</u> daily trips.
Gallons of production: <u>0</u> / 1,000 x .009 truck trips daily ³ x 2 one-way trips	=	<u>0</u> daily trips.
Total	=	<u>64</u> daily trips.
Number of total weekday trips x .38	=	<u>24</u> PM peak trips.

Traffic during a Typical Saturday

Number of FT employees (on Saturdays): <u>7</u> x 3.05 one-way trips per employee	=	<u>21</u> daily trips.
Number of PT employees (on Saturdays): <u>2</u> x 1.90 one-way trips per employee	=	<u>4</u> daily trips.
Average number of weekend visitors: <u>50</u> / 2.8 visitors per vehicle x 2 one-way trips	=	<u>36</u> daily trips.
Total	=	<u>61</u> daily trips.
Number of total Saturday trips x .57	=	<u>35</u> PM peak trips.

Traffic during a Crush Saturday

Number of FT employees (during crush): <u>0</u> x 3.05 one-way trips per employee	=	<u>0</u> daily trips.
Number of PT employees (during crush): <u>0</u> x 1.90 one-way trips per employee	=	<u>0</u> daily trips.
Average number of weekend visitors: <u>0</u> / 2.8 visitors per vehicle x 2 one-way trips	=	<u>0</u> daily trips.
Gallons of production: <u>0</u> / 1,000 x .009 truck trips daily x 2 one-way trips	=	<u>0</u> daily trips.
Avg. annual tons of grape on-haul: <u>0</u> x .11 truck trips daily ⁴ x 2 one-way trips	=	<u>0</u> daily trips.
Total	=	<u>0</u> daily trips.
Number of total Saturday trips x .57	=	<u>0</u> PM peak trips.

Largest Marketing Event- Additional Traffic

Number of event staff (largest event): <u>0</u> x 2 one-way trips per staff person	=	<u>0</u> trips.
Number of visitors (largest event): <u>0</u> / 2.8 visitors per vehicle x 2 one-way trips	=	<u>0</u> trips.
Number of special event truck trips (largest event): <u>0</u> x 2 one-way trips	=	<u>0</u> trips.

³ Assumes 1.47 materials & supplies trips + 0.8 case goods trips per 1,000 gallons of production / 250 days per year (see *Traffic Information Sheet Addendum* for reference).

⁴ Assumes 4 tons per trip / 36 crush days per year (see *Traffic Information Sheet Addendum* for reference).

Winery Traffic Information / Trip Generation Sheet

Project Name: Shadybrook Winery

Project Scenario:

Permitted

Traffic during a Typical Weekday

Number of FT employees: <u>2</u> x 3.05 one-way trips per employee	=	<u>6</u>	daily trips.
Number of PT employees: <u>1</u> x 1.90 one-way trips per employee	=	<u>2</u>	daily trips.
Average number of weekday visitors: <u>21</u> / 2.6 visitors per vehicle x 2 one-way trips	=	<u>16</u>	daily trips.
Gallons of production: <u>30000</u> / 1,000 x .009 truck trips daily ³ x 2 one-way trips	=	<u>1</u>	daily trips.
Total	=	<u>25</u>	daily trips.
Number of total weekday trips x .38	=	<u>10</u>	PM peak trips.

Traffic during a Typical Saturday

Number of FT employees (on Saturdays): <u>2</u> x 3.05 one-way trips per employee	=	<u>6</u>	daily trips.
Number of PT employees (on Saturdays): <u>1</u> x 1.90 one-way trips per employee	=	<u>2</u>	daily trips.
Average number of weekend visitors: <u>21</u> / 2.8 visitors per vehicle x 2 one-way trips	=	<u>15</u>	daily trips.
Total	=	<u>23</u>	daily trips.
Number of total Saturday trips x .57	=	<u>13</u>	PM peak trips.

Traffic during a Crush Saturday

Number of FT employees (during crush): <u>2</u> x 3.05 one-way trips per employee	=	<u>6</u>	daily trips.
Number of PT employees (during crush): <u>1</u> x 1.90 one-way trips per employee	=	<u>2</u>	daily trips.
Average number of weekend visitors: <u>21</u> / 2.8 visitors per vehicle x 2 one-way trips	=	<u>15</u>	daily trips.
Gallons of production: <u>30000</u> / 1,000 x .009 truck trips daily x 2 one-way trips	=	<u>1</u>	daily trips.
Avg. annual tons of grape on-haul: <u>158</u> x .11 truck trips daily ⁴ x 2 one-way trips	=	<u>2</u>	daily trips.
Total	=	<u>26</u>	daily trips.
Number of total Saturday trips x .57	=	<u>15</u>	PM peak trips.

Largest Marketing Event- Additional Traffic

Number of event staff (largest event): <u>3</u> x 2 one-way trips per staff person	=	<u>6</u>	trips.
Number of visitors (largest event): <u>30</u> / 2.8 visitors per vehicle x 2 one-way trips	=	<u>21</u>	trips.
Number of special event truck trips (largest event): <u>1</u> x 2 one-way trips	=	<u>2</u>	trips.

³ Assumes 1.47 materials & supplies trips + 0.8 case goods trips per 1,000 gallons of production / 250 days per year (see *Traffic Information Sheet Addendum* for reference).

⁴ Assumes 4 tons per trip / 36 crush days per year (see *Traffic Information Sheet Addendum* for reference).

Winery Traffic Information / Trip Generation Sheet

Project Name: Shadybrook Winery

Project Scenario:

Proposed

Traffic during a Typical Weekday

Number of FT employees: <u>9</u> x 3.05 one-way trips per employee	=	<u>27</u> daily trips.
Number of PT employees: <u>2</u> x 1.90 one-way trips per employee	=	<u>4</u> daily trips.
Average number of weekday visitors: <u>50</u> / 2.6 visitors per vehicle x 2 one-way trips	=	<u>38</u> daily trips.
Gallons of production: <u>70000</u> / 1,000 x .009 truck trips daily ³ x 2 one-way trips	=	<u>1</u> daily trips.
Total	=	<u>71</u> daily trips.
Number of total weekday trips x .38	=	<u>27</u> PM peak trips.

Traffic during a Typical Saturday

Number of FT employees (on Saturdays): <u>9</u> x 3.05 one-way trips per employee	=	<u>27</u> daily trips.
Number of PT employees (on Saturdays): <u>2</u> x 1.90 one-way trips per employee	=	<u>4</u> daily trips.
Average number of weekend visitors: <u>50</u> / 2.8 visitors per vehicle x 2 one-way trips	=	<u>36</u> daily trips.
Total	=	<u>67</u> daily trips.
Number of total Saturday trips x .57	=	<u>38</u> PM peak trips.

Traffic during a Crush Saturday

Number of FT employees (during crush): <u>9</u> x 3.05 one-way trips per employee	=	<u>27</u> daily trips.
Number of PT employees (during crush): <u>2</u> x 1.90 one-way trips per employee	=	<u>4</u> daily trips.
Average number of weekend visitors: <u>50</u> / 2.8 visitors per vehicle x 2 one-way trips	=	<u>36</u> daily trips.
Gallons of production: <u>70000</u> / 1,000 x .009 truck trips daily x 2 one-way trips	=	<u>1</u> daily trips.
Avg. annual tons of grape on-haul: <u>467</u> x .11 truck trips daily ⁴ x 2 one-way trips	=	<u>6</u> daily trips.
Total	=	<u>75</u> daily trips.
Number of total Saturday trips x .57	=	<u>43</u> PM peak trips.

Largest Marketing Event- Additional Traffic

Number of event staff (largest event): <u>4</u> x 2 one-way trips per staff person	=	<u>8</u> trips.
Number of visitors (largest event): <u>100</u> / 2.8 visitors per vehicle x 2 one-way trips	=	<u>71</u> trips.
Number of special event truck trips (largest event): <u>2</u> x 2 one-way trips	=	<u>4</u> trips.

³ Assumes 1.47 materials & supplies trips + 0.8 case goods trips per 1,000 gallons of production / 250 days per year (see *Traffic Information Sheet Addendum* for reference).

⁴ Assumes 4 tons per trip / 36 crush days per year (see *Traffic Information Sheet Addendum* for reference).