

“E”

Road and Street Standards Exception Request

Hard Six Cellars Winery P16-00333 & Use Permit Exception to
Conservation Regulations P19-00315
Planning Commission Hearing October 16, 2019



January 8, 2018

Patrick Ryan, PE
Engineering Supervisor
Napa County Public Works
1195 Third Street
Napa, California 94559

Subject: Use Permit Road Exception Request
Hard Six Cellars
1755 S. Fork Diamond Mountain Road
Calistoga, CA 94515
APN: 020-100-014

Patrick,

This letter is to request specific exceptions to the November 22, 2016, Napa County Road and Street Standards (RSS) for an existing driveway from Diamond Mountain Road (South Fork) to serve a proposed winery site on the subject parcel noted above. The parcel is currently accessed by a private driveway that ranges in width from 10-12 feet and serves a single-family residence and vineyards. The proposed winery is located along the existing driveway, approximately 1,050 feet distant along the centerline from its intersection with Diamond Mountain Road. This length of driveway traverses a steep and densely wooded hillside where the uphill and downhill cross slope exceeds 50%. In addition, over an approximately 40 foot section of the driveway, the longitudinal slope exceeds 21.5%.

This letter shall be considered a formal request for an exception from the RSS for the access drive based on environmental and/or legal constraints which are described below. Included with this request letter is a set of exhibits from the Revision 2 Use Permit Plan Set titled, "Hard Six Cellars," dated December 18, 2017, which detail the sections of the driveway where it 1) meets the standard, 2) does not meet the standard, 3) areas requiring an exception request, 4) and where mitigation improvements are proposed to allow the drive to meet the same overall practical effects of the RSS.

Road Exception Request Descriptions

Exception #1: Station 0+05 to 0+60

Request for Non-Standard Driveway Apron

Where the driveway meets Diamond Mountain Road (DMR), the existing pavement inside turning radius is approximately six-feet with an inside longitudinal slope of approximately 34%. The limited existing inside turning radius and steep slope are due to a nearly 160-degree turning angle between DMR and the driveway over a narrow driveway apron area. The existing driveway apron width and turning angle are constrained by an approximately 250% uphill cut slope (near vertical) and 80% downhill cross slope. Additionally, the driveway apron is located within a 40-foot wide easement over the adjacent parcel which constrains the extent of improvements available for the initial 170-feet of the driveway.

Improving the driveway to provide a standard 90-degree turning angle with a 20-foot inside turning radius per RSS Detail P-2 would require excessive grading into the 250% cut slope and grading outside of the 40-foot easement boundary. It should further be noted that a Napa County definitional creek is located on the west side of DMR (across DMR from the entrance), and improvements to the driveway apron will require grading within the creek setback. Therefore, due to limited physical space, steep slopes, and easement constraints on both sides of the driveway, installation of a RSS Driveway Apron per Detail P-2 is not feasible.

Proposed Mitigation



To provide the same overall practical effect as the RSS, Hard Six Cellars (HSC) requests to widen the inside pavement extents by approximately 10-feet and reduce the inside slope to approximately 18% while maintaining the existing inside turning radius of six feet. This will allow for a fully loaded fire apparatus to access the driveway in a single turning movement.

To verify the ability of a fire apparatus to access the site, an analysis was conducted using AutoDesk Autoturn with Napa County Fire Truck Parameters (8.0 ft. wide, 30.56 ft. long) to 'drive' the truck into the site based on the mitigated site improvements. Additionally, the brush and tree limbs will be cleared to improve the line of sight and a new caution sign will be installed on DMR to notify drivers of the upcoming driveway intersection. Please reference sheets UP2.0 and UP2.1 in the Road Exception Exhibit for the proposed mitigation measures and an analysis of the truck movement to the site.

Exception Request #2: Station 0+60 to 4+50

Request for Roadway Width Less Than 22 feet.

In this section, the existing driveway width varies from 10-12 feet of paved surface and has a blind curve (#1) between Stations 3+60 and 4+50. To widen the driveway to 22-feet, extensive grading would have to occur on adjacent cross slopes of greater than 50%, tree removal, and an exception to the Conservation Regulations for grading on slopes in excess of 30%.

Proposed Mitigation

HSC requests to widen the driveway to the Maximum Extent Practical by providing a one-foot shoulder beginning on the outside (left side of drive facing up station) top of slope and pave the remaining width to an asphalt curb on the toe of the uphill cut slope to achieve an overall width ranging from 12-20 feet. Additionally, to mitigate the blind corner (#1), HSC proposes to install a County Standard turnout (#1) from station 3+60 to 4+50 (through the blind turn). Brush and tree limbs will be cleared to improve sight distance along the driveway. A notification sign shall be placed at station 0+90 stating to uphill drivers "Road Narrows: Uphill Traffic has Right-of-Way" and another at 4+95 stating to downhill drivers "Turnout Ahead. Uphill Traffic has Right-of-Way. Use Turnouts". The proposed areas of widening to the existing driveway are hatched for easy identification on sheets UP2.1 and UP2.2 of the attached exhibits.

Exception #3, Stations 4+40 to 7+00

Request Roadway Grade of 19.5% without a preceding and ensuing 10% slope

Beginning at station 4+40 and ending at station 7+00, the existing driveway has an average grade of approximately 18.5%; within this section, between station 4+40 and 4+80, the existing roadway has an average centerline grade of approximately 21.5%. The average slope of the 100-feet preceding station 4+40 is approximately 15% and the average slope of the 100-feet ensuing station 7+00 is 15.5%. Either reducing the roadway grade below 18% between stations 4+40 and 7+00 or reducing the roadway grade below 20% between stations 4+40 and 4+80 with a 10% grade for 100-feet preceding and ensuing would require excessive grading into adjacent slopes of greater than 50% requiring an exception to the Conservation Regulations and tree removal. In addition, three trees located immediately at the existing left (facing up-station) edge of pavement between Stations 5+20 and 5+70 are proposed to remain. The trees are: 36" fir, 14" oak, and 16" oak (according to survey). In addition, there is a 60" fir located at the right edge of pavement at approximately Station 6+85 which is also to remain.

Proposed Mitigation

HSC proposes to match the existing road grade of 19.5% at station 4+40, hold that grade to station 4+86, install a 100-foot vertical curve with an ensuing road grade of 17.9%, and hold that grade to station 7+00, where it ties into an existing road grade of 17.9%. The proposed roadway grade profile is provided on sheet UP2.3 of the attached exhibits.

Exception Request #4: Station 4+25 to 8+00:



Request for Roadway Width Less Than 22 feet.

In this section, the existing driveway width varies from 10-12 feet of paved surface and has a blind curve (#2) between Stations 6+30 and 7+10. To widen the common driveway to 22-feet, extensive grading would have to occur on slopes greater than 50% which would require an exception to the Conservation Regulations and tree removal.

Proposed Mitigation

Beginning at the end of the proposed turnout #1 (Station 4+50 as noted in Exception #2 above), widen the driveway to the Maximum Extent Practical (MEP) by providing a one-foot shoulder on the outside/downhill edge and paving the entire width to the toe of the uphill cut slope up to Station 6+52 to provide a width ranging between 14-22 feet. Between Stations 6+25 and 7+10 (blind corner #2), the driveway will be widened to the Maximum Extent Practical to create a non-standard turnout. The widths will range from 19 feet at Station 6+25, to 22 feet at Station 6+50, to approximately 19 feet at Station 6+80. The section between Stations 6+35 – 6+75 will provide approximately 20 feet of width. The turnout is non-standard due to excessive lateral slopes limiting the ability to construct standard tapers and inability to provide the required 22 feet of width at the turnout itself.

From station 6+52 to the end of the exception request area at station 8+00, the driveway daylight to a cut slope on each side. HSC proposes to install curbs on both sides of the driveway and widen to the face of curb to provide a width ranging between 12-22 feet. The proposed areas of widening to the existing driveway are hatched for easy identification on sheets UP2.3 and UP2.4 of the attached exhibits.

A notification sign shall be placed at approximately Station 8+05 stating to the downhill drivers "Road Narrows. Uphill Traffic has Right-of-Way. Use Turnouts".

Beyond Station 8+00, the access drive shall meet the County Standard width and slope requirements for a winery.

Summary

The Applicant proposes to widen the driveway to the Maximum Extent Practical and regrade the centerline slope to a maximum of 19.5% in the areas where the slope exceeds 20% to achieve the same practical effect as if the road met the RSS. Additionally, the applicant proposes to provide a County Standard turnout #1 at the blind curve between stations 3+60 and 4+50, a non-standard turnout #2 between stations 6+25 and 7+10, and install warning traffic signs at stations 0+90, 4+95, and 8+05. All requested exceptions to the RSS are due to avoid the necessity to grade on slopes in excess of 30%, grading adjacent to a creek along Diamond Mountain Road, to preserve the trees in the surrounding environment, and/or due to legal constraints. Other sections of the driveway outside of this road exception request shall meet the Napa County Road and Street Standards dated November 22, 2016.

It is our request that this modification to the Napa County Road and Street Standards be approved with the proposed improvements described above.

Please feel free to contact me if you have any questions.

Sincerely,

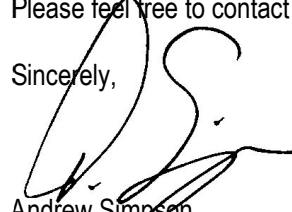

Andrew Simpson
Principal

Attachments

Road Exception Exhibit (11x17 reduced size version of sheets UP2.0 – UP2.6 from Rev2 Use Permit Plan Set)

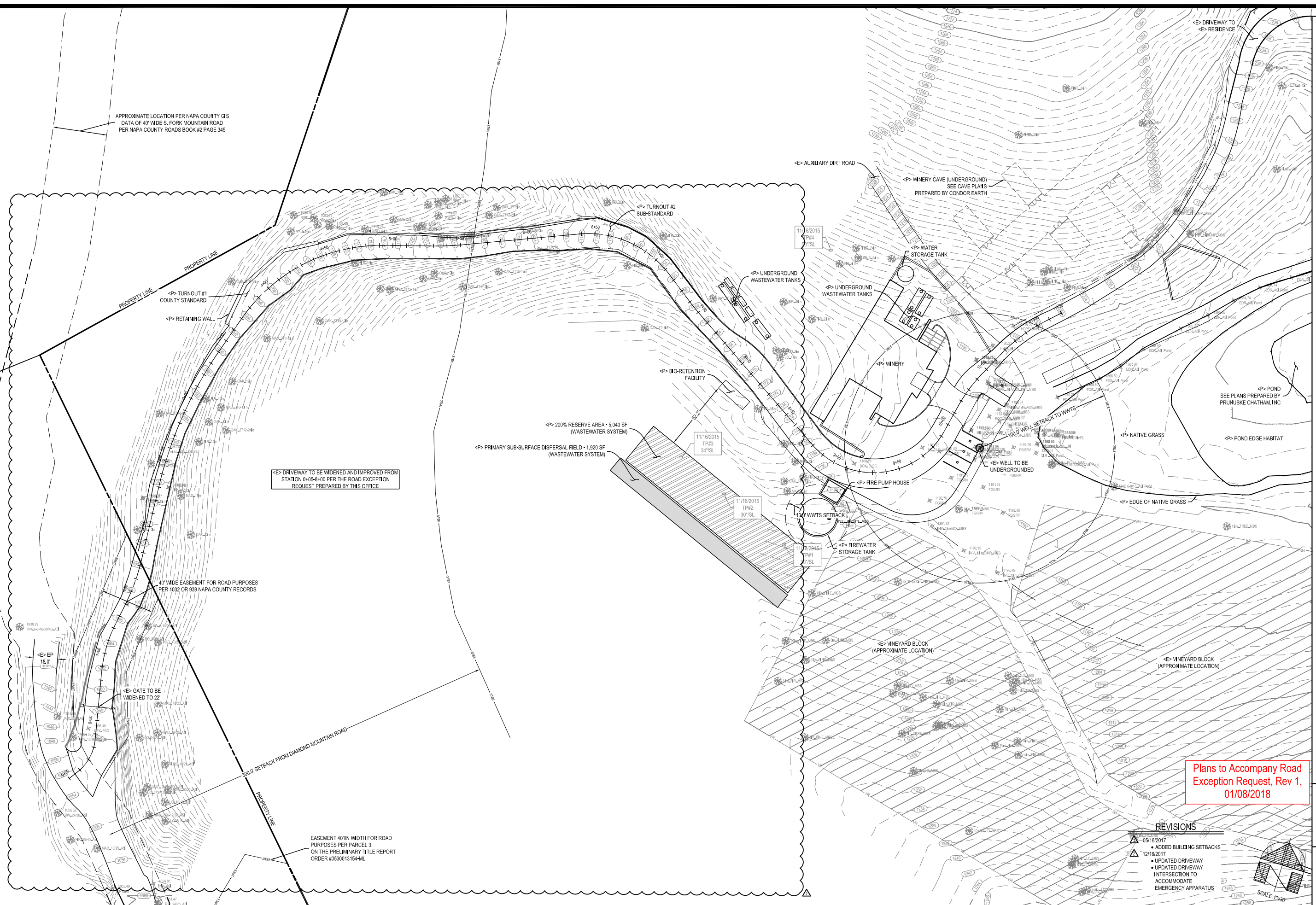

THESE PLANS AND SPECIFICATIONS ARE PREPARED BY THE ENGINEER AND ARCHITECT BASED ON THE INFORMATION PROVIDED BY THE CLIENT. THE ENGINEER AND ARCHITECT MAKE NO WARRANTY, REPRESENTATION OR GUARANTEE AS TO THE ACCURACY, COMPLETENESS OR SUITABILITY OF THE INFORMATION PROVIDED. THE ENGINEER AND ARCHITECT SHALL BE RESPONSIBLE FOR THE DESIGN AND CONSTRUCTION OF THE PROJECT. THE CLIENT SHALL BE RESPONSIBLE FOR OBTAINING ALL NECESSARY PERMITS AND APPROVALS FROM THE APPROPRIATE AGENCIES. THE ENGINEER AND ARCHITECT SHALL NOT BE RESPONSIBLE FOR ANY DELAYS OR COSTS INCURRED BY THE CLIENT AS A RESULT OF OBTAINING PERMITS AND APPROVALS. THE ENGINEER AND ARCHITECT SHALL NOT BE RESPONSIBLE FOR ANY CHANGES TO THE PLANS OR SPECIFICATIONS MADE BY THE CLIENT OR ANY OTHER PARTY. THE ENGINEER AND ARCHITECT SHALL NOT BE RESPONSIBLE FOR ANY DAMAGE TO PERSONS OR PROPERTY CAUSED BY THE PROJECT. THE ENGINEER AND ARCHITECT SHALL NOT BE RESPONSIBLE FOR ANY CONSEQUENTIAL DAMAGES. THE ENGINEER AND ARCHITECT SHALL NOT BE RESPONSIBLE FOR ANY OTHER MATTERS NOT EXPRESSLY STATED IN THESE PLANS AND SPECIFICATIONS. THE ENGINEER AND ARCHITECT SHALL NOT BE RESPONSIBLE FOR ANY OTHER MATTERS NOT EXPRESSLY STATED IN THESE PLANS AND SPECIFICATIONS.

DELTA CONSULTING & ENGINEERING
 OF ST. HELENA

1104 ADAMS STREET, SUITE 203, ST. HELENA, CALIFORNIA 94574
 707-963-9486 • 707-963-8528 FAX

USE PERMIT
 OVERALL SITE PLAN

HARD SIX CELLARS
 1755 S. FORK DIAMOND MOUNTAIN ROAD
 CALISTOGA, CA 94515
 APN: 020-100-014
 PROJECT: M116



EVERY PERSON PLANNING TO BUILD
 CALL US AT 707-963-9486

FOR MORE INFORMATION
 SEE WWW.DELTAENGINEERING.COM

UP1.2

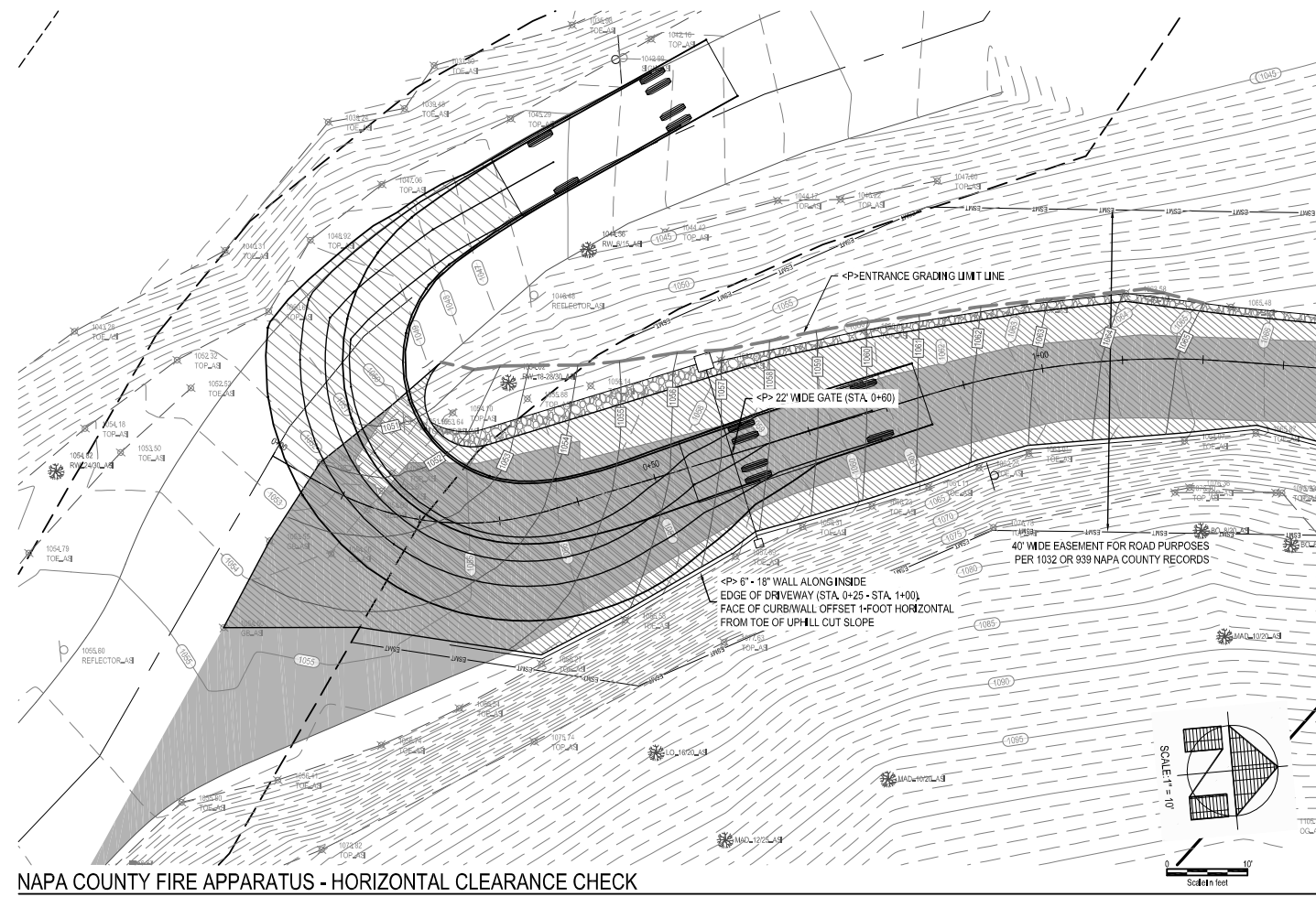

NAPA COUNTY FIRE APPARATUS - HORIZONTAL CLEARANCE CHECK

THE NAPA COUNTY FIRE APPARATUS HORIZONTAL CLEARANCE CHECK WAS MODELED USING AUTOTURN 8.0 DEVELOPED BY TRANSOFT SOLUTIONS
 ADDITIONAL SITE AND DESIGN INFORMATION PROVIDED ON SHEET UP 2.1

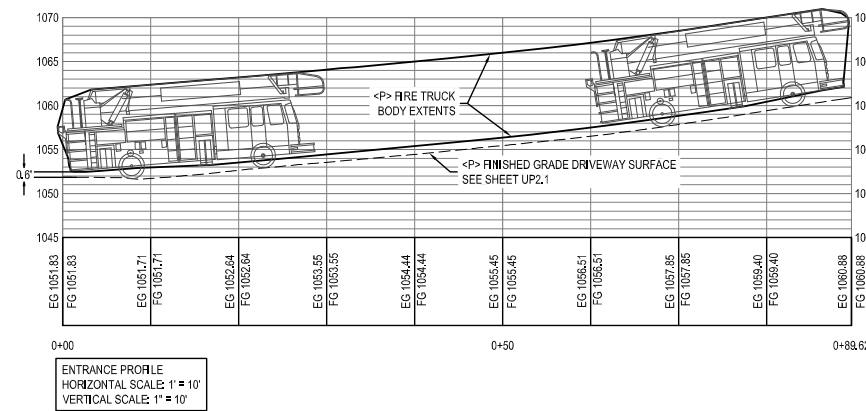

NAPA COUNTY FIRE APPARATUS - VERTICAL CLEARANCE CHECK

THE NAPA COUNTY FIRE APPARATUS VERTICAL CLEARANCE CHECK WAS MODELED USING AUTOCAD 2016 VEHICLE TRACKING

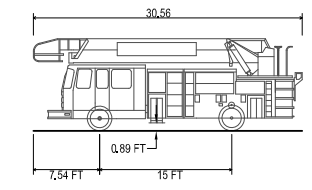

NAPA COUNTY FIRE APPARATUS

OVERALL LENGTH	30.56 FT
OVERALL WIDTH	8.00 FT
OVERALL BODY HEIGHT	10.46 FT
MIN BODY GROUND CLEARANCE	0.89 FT
MAX TRACK WIDTH	7.15 FT
LOOK-TO-LOOK TIME	5.0 S
MAX STEERING ANGLE	40.0°

REVISIONS

12/18/17	NEW SHEET DEDICATED TO FIRE DEPARTMENT ACCESS
----------	---

Plans to Accompany Road Exception Request, Rev 1, 01/08/2018

CONTRACTOR'S RESPONSIBILITY: THE CONTRACTOR SHALL BE RESPONSIBLE FOR OBTAINING ALL NECESSARY PERMITS AND APPROVALS FROM ALL AFFECTED AGENCIES AND AGENCIES OF THE STATE OF CALIFORNIA. THE CONTRACTOR SHALL BE RESPONSIBLE FOR OBTAINING ALL NECESSARY PERMITS AND APPROVALS FROM ALL AFFECTED AGENCIES AND AGENCIES OF THE STATE OF CALIFORNIA. THE CONTRACTOR SHALL BE RESPONSIBLE FOR OBTAINING ALL NECESSARY PERMITS AND APPROVALS FROM ALL AFFECTED AGENCIES AND AGENCIES OF THE STATE OF CALIFORNIA.

DELTA CONSULTING & ENGINEERING
 OF ST. HELENA
 1104 ADAMS STREET, SUITE 203, ST. HELENA, CALIFORNIA 94574
 707-963-9486 • 707-963-8528 FAX

USE PERMIT
FIRE APPARATUS ACCESS

HARD SIX CELLARS
 1755 S. FORK DIAMOND MOUNTAIN ROAD
 CALISTOGA, CA 94515
 APN: 020-100-014
 PROJECT: N-116



DATE: 09/24/16
 05/16/17
 12/18/17

ISSUE: PERMIT SET
 PLAN CHECK
 PLAN CHECK

SHEET: **UP 2.0**

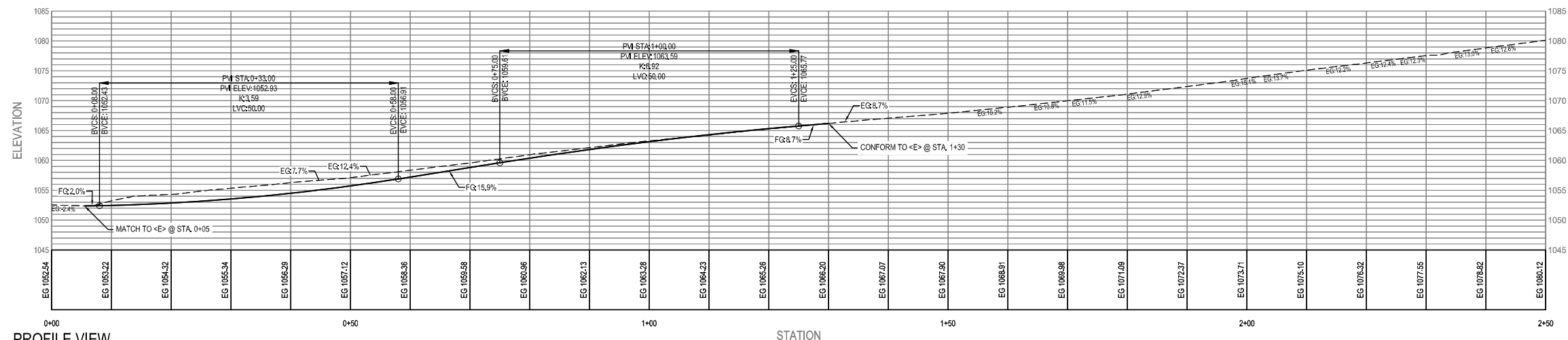
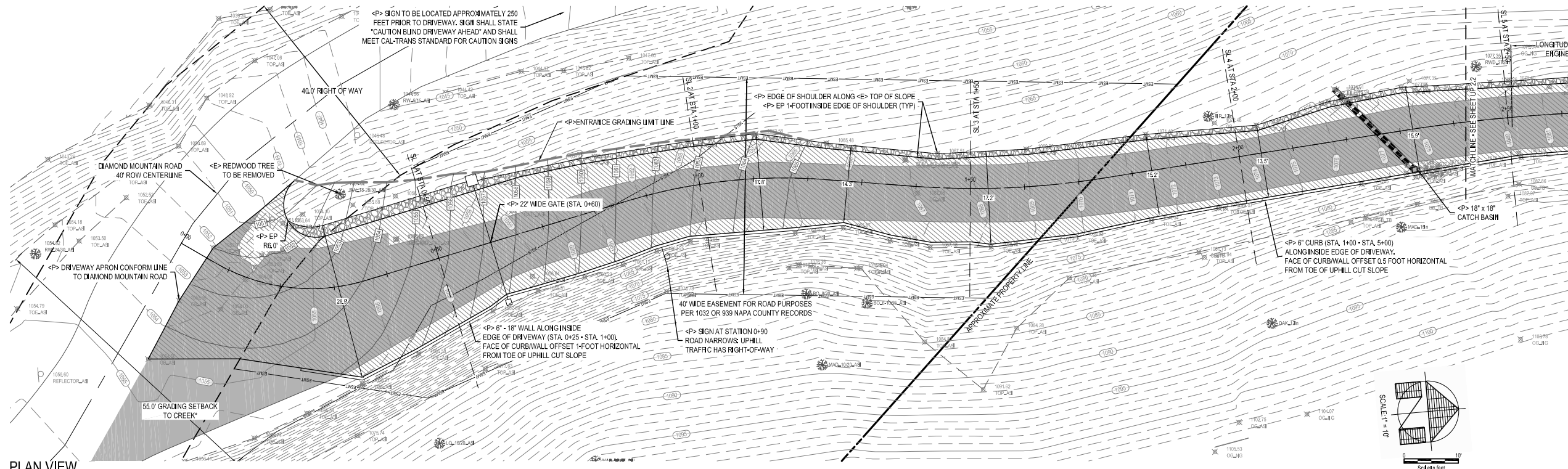

ROAD EXCEPTION REQUEST TABLE					
EXCEPTION #	STATION RANGE	REQUEST	STANDARD*	CONSTRAINT	MITIGATION
1	0+05 - 0+60	NON-STANDARD DRIVEWAY APRON	DRIVEWAY APRON DETAIL P-2	-PHYSICAL SITE LIMITATIONS, ADJACENT CROSS SLOPES >50% -EASEMENT BOUNDARY	-EXISTING APRON TOO NARROW AND STEEP FOR EMERGENCY APPARATUS TO MAKE TURN INTO DRIVEWAY -REGRADE TO PROVIDE ADEQUATE WIDTH AND VERTICAL CURVE FOR EMERGENCY APPARATUS ACCESS
2	0+60 - 4+50	ROAD WIDTH LESS THAN 22 FEET	ROAD WIDTH OF 22-FEET	-PHYSICAL SITE LIMITATIONS, ADJACENT CROSS SLOPES >50%	-EXISTING DRIVEWAY WIDTH VARIES FROM 10-12 FEET WIDE -WIDEN TO MAXIMUM EXTENT PRACTICAL AS SHOWN ON THE PLANS (~14-23 FEET) -CLEAR BRUSH AND LIMBS FROM TREES -INSTALL ONE STANDARD TURNOUT, FROM STA. 3+60 - 4+50, AT BOUNDARY #1 -INSTALL NARROW ROAD WARNING SIGNAGE
3	4+40 - 7+00	ROAD SLOPE OF 19.5% FOR ~46-FEET WITH >10% SLOPES PRECEDING & ENSUING	-ROAD SLOPE <20% -ROAD SLOPES 18%-20% REQUIRE <10% SLOPE PRECEDING & ENSUING	-PHYSICAL SITE LIMITATIONS, LONGITUDINAL SLOPE AVERAGE ~21% STA. 4+40 - 4+80 AND ~18.5% STA. 4+40 - 7+00 -GRAVING TO PROVIDE <18% SLOPE OR <10% SLOPE PRECEDING & ENSUING REQUIRES EXCESSIVE GRADING INTO ADJACENT CROSS SLOPES >50%	-REDUCE LONGITUDINAL SLOPE TO 19.5% BEGINNING AT STA. 4+40, INSTALL 100-FT VERTICAL CURVE AND CONFORM TO <E> DRIVEWAY SLOPE = 17.9% BY STA. 7+00
4	4+50 - 8+00	ROAD WIDTH LESS THAN 22 FEET	ROAD WIDTH OF 22-FEET	-PHYSICAL SITE LIMITATIONS, ADJACENT CROSS SLOPES >50%	-EXISTING DRIVEWAY WIDTH VARIES FROM 10-12 FEET WIDE -WIDEN TO MAXIMUM EXTENT PRACTICAL AS SHOWN ON THE PLANS (~14-23 FEET) -CLEAR BRUSH AND LIMBS FROM TREES -INSTALL ONE NON-STANDARD TURNOUT, FROM STA. 6+15 - 6+50, AT BOUNDARY #2 -INSTALL NARROW ROAD WARNING SIGNAGE

ROAD EXCEPTION NUMBERS CORRELATE WITH THE ROAD EXCEPTION REQUEST LETTER PREPARED BY THIS OFFICE DATED JANUARY 8, 2018. SEE THE ROAD EXCEPTION LETTER FOR A DETAILED DESCRIPTION OF EACH NUMBERED ITEM.

*ALL INFORMATION IN THE "STANDARD" COLUMN IS FROM THE NOVEMBER 22, 2016, VERSION OF THE NAPA COUNTY ROAD AND STREET STANDARDS

DRIVEWAY SURFACE HATCH LEGEND

- EXISTING PAVEMENT
- PROPOSED PAVEMENT/PAVING EXTENTS
- PROPOSED GRAVEL SHOULDER

Plans to Accompany Road Exception Request, Rev 1, 01/08/2018

- REVISIONS
- 12/18/17 NEW SHEET, ROAD EXCEPTION REQUEST EXHIBITS NOW INCLUDED IN USE PERMIT PLAN SET FOR CONSISTENCY
 - 09/24/16 UPDATED ROAD EXCEPTION REQUEST DESIGN TO CONFORM WITH CURRENT NAPA COUNTY ROAD AND STREET STANDARDS
 - 05/16/17 CROSS SECTIONS NOW PROVIDED IN ROAD EXCEPTION REQUEST AREAS
 - 12/18/17 UPDATED ROAD EXCEPTION REQUEST TABLE TO REDUCE REDUNDANT LINE ITEMS
 - 09/24/16 WIDENED ROAD TO MAXIMUM EXTENT PRACTICAL WITHOUT ENCRoACHING IN ADJACENT CROSS SLOPES >50%
 - 12/18/17 ENTRY VERTICAL CURVE DESIGN NOW INCLUDED. SEE SHEET UP 2.0 FOR FIRE TRUCK VERTICAL CLEARANCE CHECK

DELTA CONSULTING & ENGINEERING OF ST. HELENA
 1104 ADAMS STREET, SUITE 203, ST. HELENA, CALIFORNIA 94574
 707-963-9486 + 707-963-8528 FAX

USE PERMIT
 PLAN AND PROFILE

HARD SIX CELLARS
 1755 S. FORK DIAMOND MOUNTAIN ROAD
 CALISTOGA, CA 94515
 APN: 020-100-014
 PROJECT: M116



DATE: 09/24/16
 ISSUE: PERMIT SET
 05/16/17 PLAN CHECK
 12/18/17 PLAN CHECK

UP 2.1

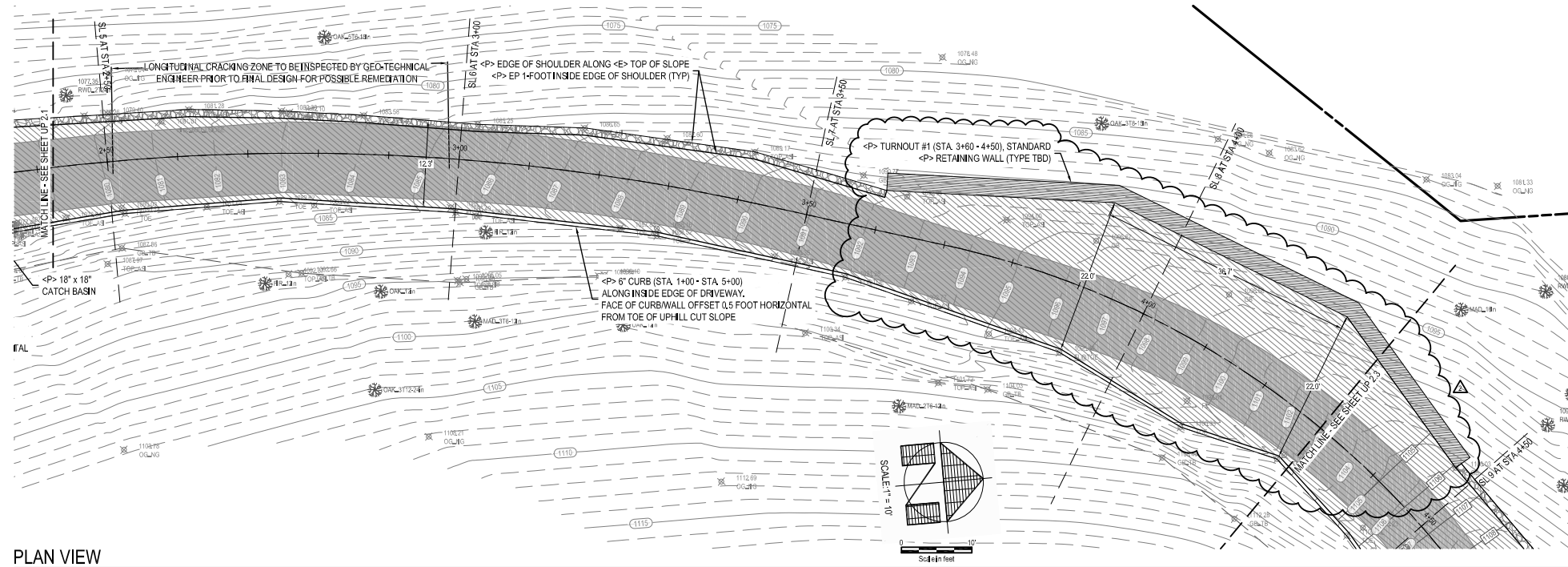

PLAN VIEW

ALL CROSS SECTION MEWS PROVIDED ON SHEET UP 2.6

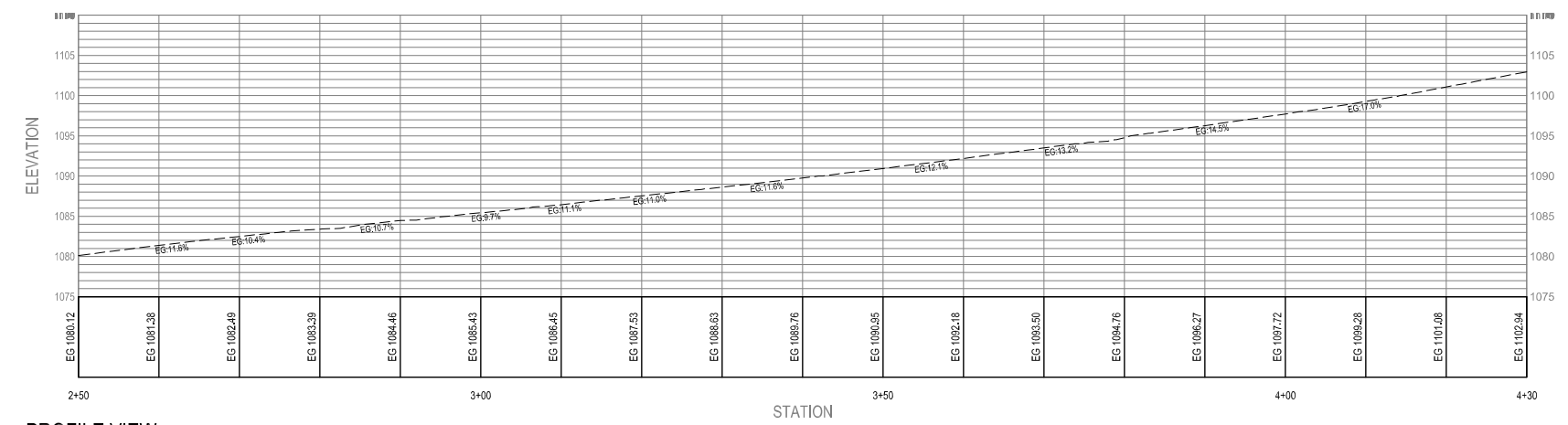

PROFILE VIEW

ROAD EXCEPTION REQUEST TABLE					
EXCEPTION #	STATION RANGE	REQUEST	STANDARD*	CONSTRAINT	MITIGATION
1	0+05 - 0+60	NON-STANDARD DRIVEWAY APRON	DRIVEWAY APRON DETAIL P-2	•PHYSICAL SITE LIMITATIONS. •ADJACENT CROSS SLOPES >50% •EASEMENT BOUNDARY	•EXISTING APRON TOO NARROW AND STEEP FOR EMERGENCY APPARATUS TO MAKE TURN INTO DRIVEWAY •RE-GRADE TO PROMOTE ADEQUATE WIDTH AND VERTICAL CURVE FOR EMERGENCY APPARATUS ACCESS
2	0+60 - 4+50	ROAD WIDTH LESS THAN 22 FEET	ROAD WIDTH OF 22-FEET	•PHYSICAL SITE LIMITATIONS. •ADJACENT CROSS SLOPES >50%	•EXISTING DRIVEWAY WIDTH VARIES FROM 10-12 FEET WIDE •WIDEN TO MAXIMUM EXTENT PRACTICAL AS SHOWN ON THE PLANS (-12-20 FEET). •CLEAR BRUSH AND LIMBS FROM TREES •INSTALL ONE STANDARD TURNOUT, FROM STA. 3+60 - 4+50, AT BLIND CURVE #1 •INSTALL NARROW ROAD WARNING SIGNAGE
3	4+40 - 7+00	ROAD SLOPE OF 18.5% FOR -46-FEET WITH >10% SLOPES PRECEDING & ENSUING	•ROAD SLOPE <20% •ROAD SLOPES 18%-20% REQUIRE <10% SLOPE PRECEDING & ENSUING	•PHYSICAL SITE LIMITATIONS •LONGITUDINAL SLOPE AVERAGE ~21% STA. 4+40 - 4+80 AND ~18.5% STA. 4+40 - 7+00 •GRADING TO PROMOTE <18% SLOPE OR <10% SLOPE PRECEDING & ENSUING REQUIRES EXCESSIVE GRADING TO ADJACENT CROSS SLOPES >50%	•REDUCE LONGITUDINAL SLOPE TO 18.5% BEGINNING AT STA. 4+40, INSTALL 100-FT VERTICAL CURVE AND CONFORM TO <E> DRIVEWAY SLOPE = 17.9% BY STA. 7+00
4	4+50 - 8+00	ROAD WIDTH LESS THAN 22 FEET	ROAD WIDTH OF 22-FEET	•PHYSICAL SITE LIMITATIONS. •ADJACENT CROSS SLOPES >50%	•EXISTING DRIVEWAY WIDTH VARIES FROM 10-12 FEET WIDE •WIDEN TO MAXIMUM EXTENT PRACTICAL AS SHOWN ON THE PLANS (-14-23 FEET). •CLEAR BRUSH AND LIMBS FROM TREES •INSTALL ONE NON-STANDARD TURNOUT, FROM STA. 6+15 - 8+00, AT BLIND CURVE #2 •INSTALL NARROW ROAD WARNING SIGNAGE

DRIVEWAY SURFACE HATCH LEGEND

- EXISTING PAVEMENT
- PROPOSED PAVEMENT/PAVING EXTENTS
- PROPOSED GRAVEL SHOULDER

ROAD EXCEPTION NUMBERS CORRELATE WITH THE ROAD EXCEPTION REQUEST LETTER PREPARED BY THIS OFFICE DATED JANUARY 8, 2018. SEE THE ROAD EXCEPTION LETTER FOR A DETAILED DESCRIPTION OF EACH NUMBERED ITEM.

*ALL INFORMATION IN THE "STANDARD" COLUMN IS FROM THE NOVEMBER 22, 2016, VERSION OF THE NAPA COUNTY ROAD AND STREET STANDARDS

Plans to Accompany Road Exception Request, Rev 1, 01/08/2018

- REVISIONS**
- 12/18/17
 - NEW SHEET, ROAD EXCEPTION REQUEST EXHIBITS NOW INCLUDED IN USE PERMIT PLAN SET FOR CONSISTENCY
 - UPDATED ROAD EXCEPTION REQUEST DESIGN TO CONFORM WITH CURRENT NAPA COUNTY ROAD AND STREET STANDARDS
 - CROSS SECTIONS NOW PROVIDED IN ROAD EXCEPTION REQUEST AREAS
 - UPDATED ROAD EXCEPTION REQUEST TABLE TO REDUCE REDUNDANT LINE ITEMS
 - WIDENED ROAD TO MAXIMUM EXTENT PRACTICAL WITHOUT ENCRDACHING IN ADJACENT CROSS SLOPES >50%
 - MINOR UPDATES TO DRIVEWAY TURNOUT RETAINING WALL LAYOUT TO ENCOMPASS MORE OF BLIND CURVE

THESE PLANS AND SPECIFICATIONS ARE PREPARED BY AN ENGINEER OR ARCHITECT REGISTERED IN THE STATE OF CALIFORNIA. THE REGISTERED PROFESSIONAL SEAL AND SIGNATURE OF THE ENGINEER OR ARCHITECT IS REQUIRED ON THESE PLANS AND SPECIFICATIONS. THE REGISTERED PROFESSIONAL SEAL AND SIGNATURE OF THE ENGINEER OR ARCHITECT IS REQUIRED ON THESE PLANS AND SPECIFICATIONS. THE REGISTERED PROFESSIONAL SEAL AND SIGNATURE OF THE ENGINEER OR ARCHITECT IS REQUIRED ON THESE PLANS AND SPECIFICATIONS.

DELTA CONSULTING & ENGINEERING
OF ST. HELENA

1104 ADAMS STREET, SUITE 203, ST. HELENA, CALIFORNIA 94574
707-963-9486 • 707-963-8528 FAX

USE PERMIT

PLAN AND PROFILE

HARD SIX CELLARS
1755 S. FORK DIAMOND MOUNTAIN ROAD
CALISTOGA, CA 94515
APN: 020-100-014
PROJECT: N-116



DATE: 08/24/16
08/16/17
12/18/17

ISSUE: PERMIT SET
PLAN CHECK
PLAN CHECK

UP 2.2

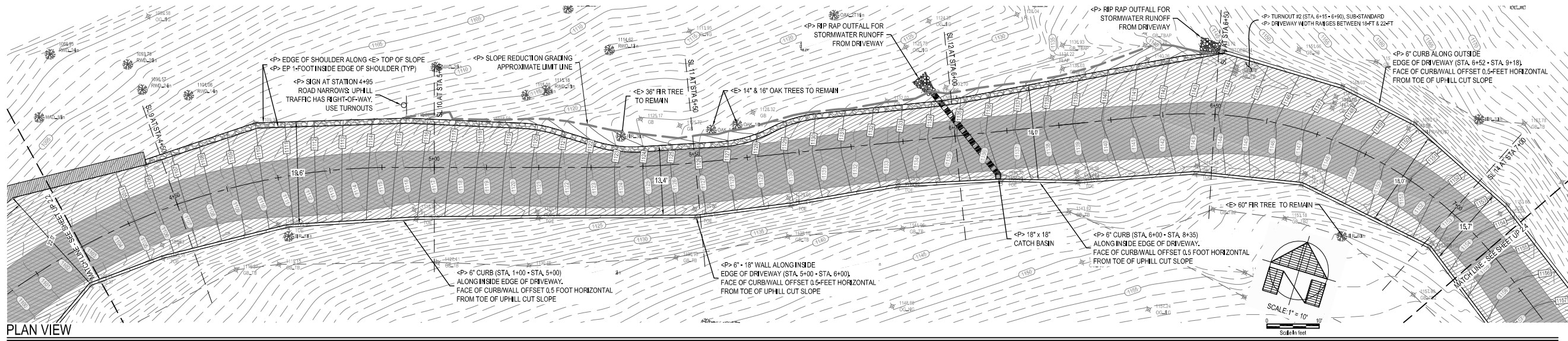

PLAN VIEW

ALL CROSS SECTION MEWS PROVIDED ON SHEET UP 2.6

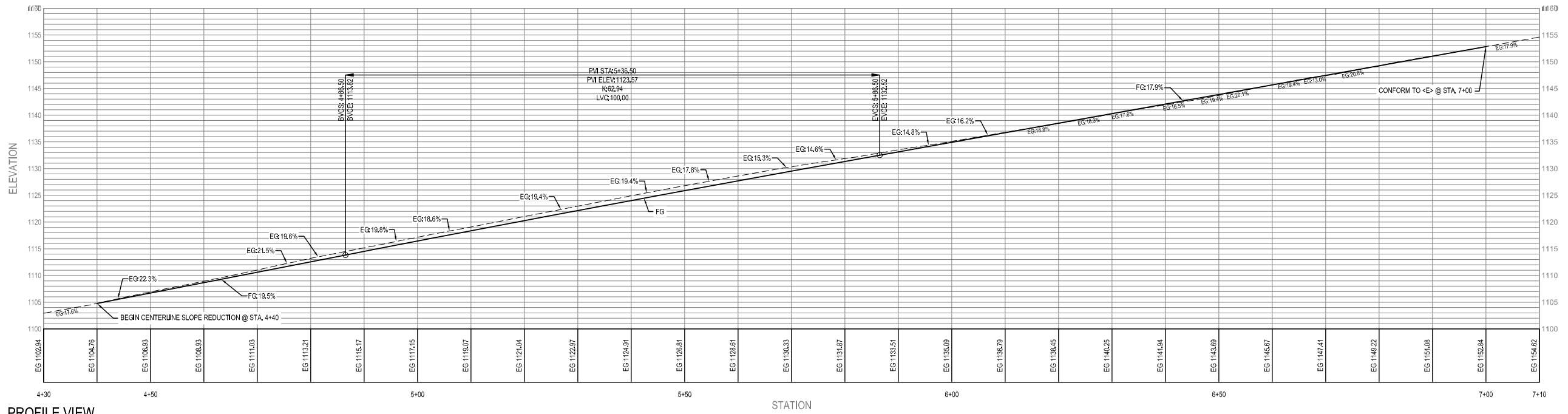

PROFILE VIEW

ROAD EXCEPTION REQUEST TABLE

EXCEPTION #	STATION RANGE	REQUEST	STANDARD*	CONSTRAINT	MITIGATION
1	0+05 - 0+60	NON-STANDARD DRIVEWAY APRON	DRIVEWAY APRON DETAIL P-2	PHYSICAL SITE LIMITATIONS, ADJACENT CROSS SLOPES >50% EASEMENT BOUNDARY	EXISTING APRON TOO NARROW AND STEEP FOR EMERGENCY APPARATUS TO MAKE TURN INTO DRIVEWAY RE-GRADE TO PROVIDE ADEQUATE WIDTH AND VERTICAL CURVE FOR EMERGENCY APPARATUS ACCESS
2	0+60 - 4+50	ROAD WIDTH LESS THAN 22 FEET	ROAD WIDTH OF 22 FEET	PHYSICAL SITE LIMITATIONS, ADJACENT CROSS SLOPES >50%	EXISTING DRIVEWAY WIDTH VARIES FROM 10-12 FEET WIDE WIDEN TO MAXIMUM EXTENT PRACTICAL AS SHOWN ON THE PLANS (-12-20 FEET). CLEAR BRUSH AND LIMBS FROM TREES INSTALL ONE STANDARD TURNOUT, FROM STA. 3+60 - 4+50, AT BLIND CURVE #1 INSTALL NARROW ROAD WARNING SIGNAGE
3	4+40 - 7+00	ROAD SLOPE OF 19.5% FOR -46 FEET WITH >10% SLOPES PRECEDING & ENSUING	ROAD SLOPE <20% ROAD SLOPES 18%-20% REQUIRE <10% SLOPE PRECEDING & ENSUING	PHYSICAL SITE LIMITATIONS, LONGITUDINAL SLOPE AVERAGE -21% STA. 4+40 - 4+80 AND -18.5% STA. 4+80 - 7+00 GRADING TO PROVIDE <18% SLOPE OR <10% SLOPE PRECEDING & ENSUING REQUIRES EXCESSIVE GRADING INTO ADJACENT CROSS SLOPES >50%	REDUCE LONGITUDINAL SLOPE TO 19.5% BEGINNING AT STA. 4+40, INSTALL 100-FT VERTICAL CURVE AND CONFORM TO <E> DRIVEWAY SLOPE = 17.9% BY STA. 7+00
4	4+50 - 8+00	ROAD WIDTH LESS THAN 22 FEET	ROAD WIDTH OF 22 FEET	PHYSICAL SITE LIMITATIONS, ADJACENT CROSS SLOPES >50%	EXISTING DRIVEWAY WIDTH VARIES FROM 10-12 FEET WIDE WIDEN TO MAXIMUM EXTENT PRACTICAL AS SHOWN ON THE PLANS (-14-23 FEET). CLEAR BRUSH AND LIMBS FROM TREES INSTALL ONE NON-STANDARD TURNOUT, FROM STA. 6+15 - 6+80, AT BLIND CURVE #2 INSTALL NARROW ROAD WARNING SIGNAGE

DRIVEWAY SURFACE HATCH LEGEND

- EXISTING PAVEMENT
- PROPOSED PAVEMENT/PAVING EXTENTS
- PROPOSED GRAVEL SHOULDER

ROAD EXCEPTION NUMBERS CORRELATE WITH THE ROAD EXCEPTION REQUEST LETTER PREPARED BY THIS OFFICE DATED JANUARY 8, 2018. SEE THE ROAD EXCEPTION LETTER FOR A DETAILED DESCRIPTION OF EACH NUMBERED ITEM.

*ALL INFORMATION IN THE "STANDARD" COLUMNS FROM THE NOVEMBER 22, 2016, VERSION OF THE NAPA COUNTY ROAD AND STREET STANDARDS

Plans to Accompany Road Exception Request, Rev 1, 01/08/2018

REVISIONS

- 12/18/17
- NEW SHEET, ROAD EXCEPTION REQUEST EXHIBITS NOW INCLUDED IN USE PERMIT PLAN SET FOR CONSISTENCY
- UPDATED ROAD EXCEPTION REQUEST DESIGN TO CONFORM WITH CURRENT NAPA COUNTY ROAD AND STREET STANDARDS
- CROSS SECTIONS NOW PROVIDED IN ROAD EXCEPTION REQUEST AREAS
- UPDATED ROAD EXCEPTION REQUEST TABLE TO REDUCE REDUNDANT LINE ITEMS
- WIDENED ROAD TO MAXIMUM EXTENT PRACTICAL WITHOUT ENCRoACHING IN ADJACENT CROSS SLOPES >50%

CONTRACTOR'S RESPONSIBILITY: THE CONTRACTOR SHALL BE RESPONSIBLE FOR OBTAINING ALL NECESSARY PERMITS AND FOR OBTAINING ALL NECESSARY INFORMATION FROM THE LOCAL AGENCIES AND THE PUBLIC UTILITIES COMPANIES. THE CONTRACTOR SHALL BE RESPONSIBLE FOR OBTAINING ALL NECESSARY INFORMATION FROM THE LOCAL AGENCIES AND THE PUBLIC UTILITIES COMPANIES. THE CONTRACTOR SHALL BE RESPONSIBLE FOR OBTAINING ALL NECESSARY INFORMATION FROM THE LOCAL AGENCIES AND THE PUBLIC UTILITIES COMPANIES.

DELTA CONSULTING & ENGINEERING OF ST. HELENA
1104 ADAMS STREET, SUITE 203, ST. HELENA, CALIFORNIA 94574
707-963-9486 • 707-963-8528 FAX

USE PERMIT
PLAN AND PROFILE

HARD SIX CELLARS
1755 S. FORK DIAMOND MOUNTAIN ROAD
CALISTOGA, CA 94515
APN: 020-100-014
PROJECT: N-116



EVERY PERSON PLANNING TO BUILD CALL US AT 1-800-225-2680
FOR MORE INFORMATION SEE WWW.DELTAENGINEERS.COM

DATE: 09/24/16 ISSUE: PERMIT SET
09/16/17 PLAN CHECK
12/18/17 PLAN CHECK

UP 2.3

ROAD EXCEPTION REQUEST TABLE

EXCEPTION #	STATION RANGE	REQUEST	STANDARD*	CONSTRAINT	MITIGATION
1	0+05 - 0+60	NON-STANDARD DRIVEWAY APRON	DRIVEWAY APRON DETAIL P-2	-PHYSICAL SITE LIMITATIONS, ADJACENT CROSS SLOPES >50% -EASEMENT BOUNDARY	-EXISTING APRON TOO NARROW AND STEEP FOR EMERGENCY APPARATUS TO MAKE TURN INTO DRIVEWAY -RE-GRADE TO PROVIDE ADEQUATE WIDTH AND VERTICAL CURVE FOR EMERGENCY APPARATUS ACCESS
2	0+60 - 4+50	ROAD WIDTH LESS THAN 22 FEET	ROAD WIDTH OF 22-FEET	-PHYSICAL SITE LIMITATIONS, ADJACENT CROSS SLOPES >50%	-EXISTING DRIVEWAY WIDTH VARIES FROM 10-12 FEET WIDE -WIDEN TO MAXIMUM EXTENT PRACTICAL AS SHOWN ON THE PLANS (~120 FEET) -CLEAR BRUSH AND LIMBS FROM TREES -INSTALL ONE STANDARD TURNOUT, FROM STA. 3+60 - 4+50, AT BLIND CURVE #1 -INSTALL NARROW ROAD WARNING SIGNAGE
3	4+40 - 7+00	ROAD SLOPE OF 19.5% FOR ~46-FOOT WIDTH >10% SLOPES PRECEDING & ENSLING	-ROAD SLOPE <20% -ROAD SLOPES 18%-20% REQUIRE <10% SLOPE PRECEDING & ENSLING	-PHYSICAL SITE LIMITATIONS, LONGITUDINAL SLOPE AVERAGE -21% STA. 4+40 - 4+80 AND -18.5% STA. 4+40 - 7+00 -GRAVING TO PROVIDE <18% SLOPE OR <10% SLOPE PRECEDING & ENSLING REQUIRES EXCESSIVE GRADING INTO ADJACENT CROSS SLOPES >50%	-REDUCE LONGITUDINAL SLOPE TO 19.5% BEGINNING AT STA. 4+40, INSTALL 100-FT VERTICAL CURVE AND CONFORM TO <E> DRIVEWAY SLOPE = 17.9% BY STA. 7+00
4	4+50 - 8+00	ROAD WIDTH LESS THAN 22 FEET	ROAD WIDTH OF 22-FEET	-PHYSICAL SITE LIMITATIONS, ADJACENT CROSS SLOPES >50%	-EXISTING DRIVEWAY WIDTH VARIES FROM 10-12 FEET WIDE -WIDEN TO MAXIMUM EXTENT PRACTICAL AS SHOWN ON THE PLANS (~123 FEET) -CLEAR BRUSH AND LIMBS FROM TREES -INSTALL ONE NON-STANDARD TURNOUT, FROM STA. 6+15 - 6+90, AT BLIND CURVE #2 -INSTALL NARROW ROAD WARNING SIGNAGE

ROAD EXCEPTION NUMBERS CORRELATE WITH THE ROAD EXCEPTION REQUEST LETTER PREPARED BY THIS OFFICE DATED JANUARY 8, 2018. SEE THE ROAD EXCEPTION LETTER FOR A DETAILED DESCRIPTION OF EACH NUMBERED ITEM.

*ALL INFORMATION IN THE "STANDARD" COLUMN IS FROM THE NOVEMBER 22, 2016, VERSION OF THE NAPA COUNTY ROAD AND STREET STANDARDS

DRIVEWAY SURFACE HATCH LEGEND

- EXISTING PAVEMENT
- PROPOSED PAVEMENT/PAVING EXTENTS
- PROPOSED GRAVEL SHOULDER

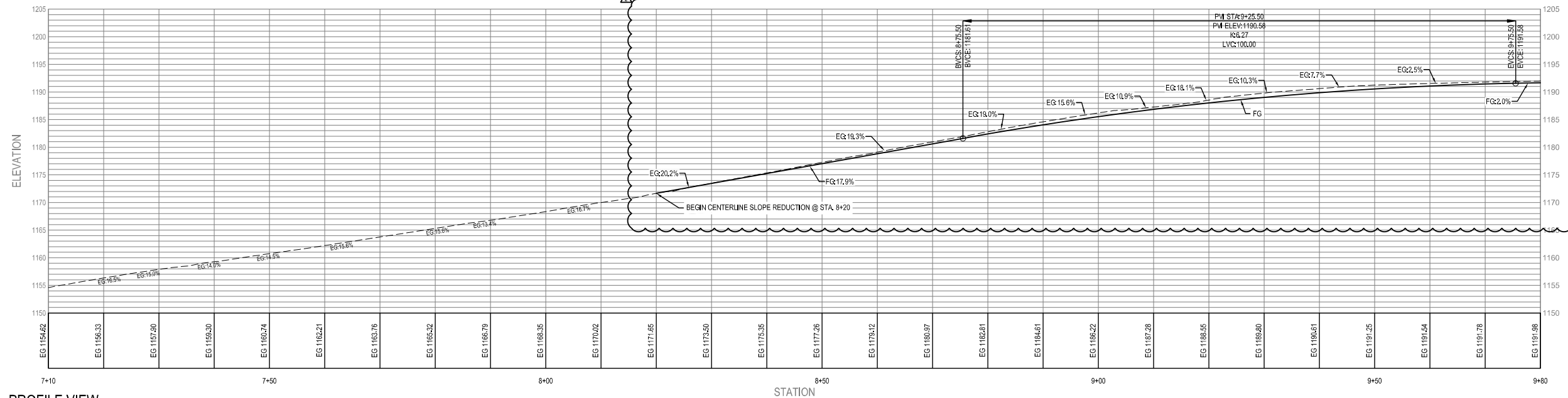
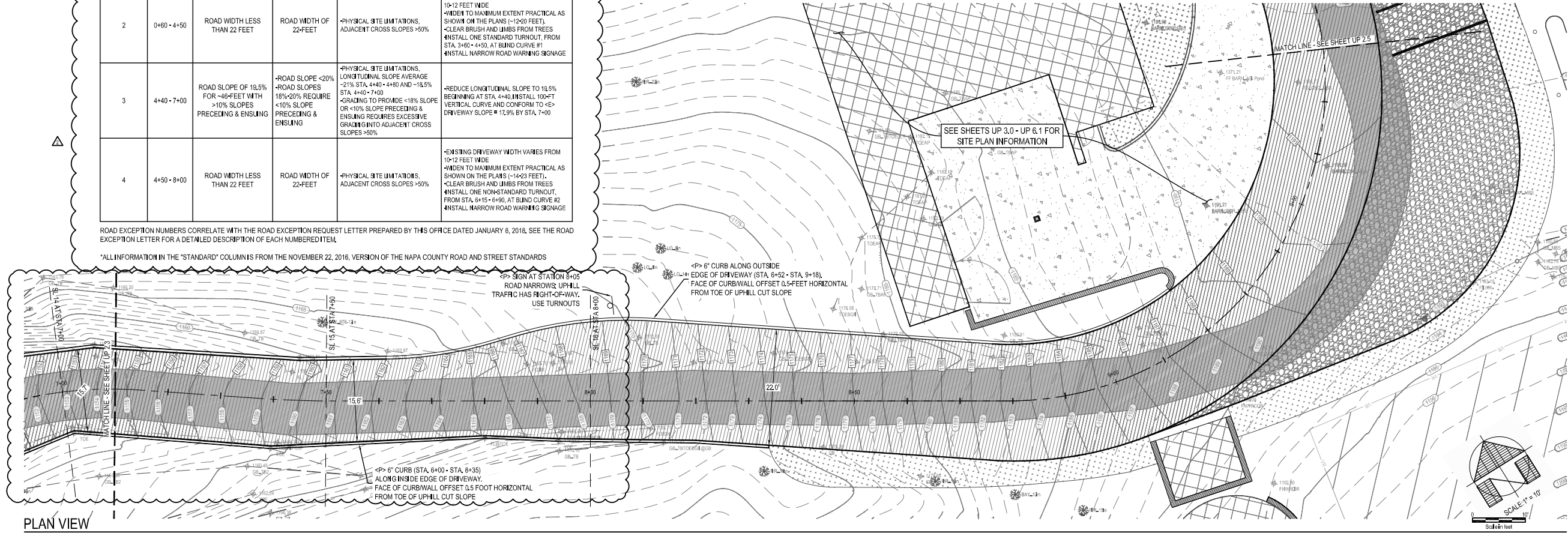

DELTA CONSULTING & ENGINEERING
OF ST. HELENA
1104 ADAMS STREET, SUITE 203, ST. HELENA, CALIFORNIA 94574
707-963-9486 + 707-963-8528 FAX

USE PERMIT
PLAN AND PROFILE

HARD SIX CELLARS
1755 S. FORK DIAMOND MOUNTAIN ROAD
CALISTOGA, CA 94515
APN: 020-100-014
PROJECT: N-116

REGISTERED PROFESSIONAL ENGINEER
ANDREW A. SIMON
No. 62537
Exp. 12-31-19
CIVIL
STATE OF CALIFORNIA

EVERY PERSON PLANNING TO DO
CALL US AT 1-800-225-2880

FOR MORE INFORMATION
SEE WWW.DELTAENGINEERS.COM

Plans to Accompany Road
Exception Request, Rev 1,
01/08/2018

- REVISIONS
- 05/16/17 NO CHANGES THIS SHEET
 - 12/18/17 PREVIOUSLY SHEET UP 2.1
 - SHIFTED START OF SLOPE REDUCTION TO STA. 8+20 TO AVOID SLOPES >18%
 - CROSS SECTIONS NOW PROVIDED IN ROAD EXCEPTION REQUEST AREAS
 - ROAD WIDTH OF 22-FEET NOW BEGINS AT STA. 8+00 (WAS 20-FEET & AT STA. 8+35 IN PLAN CHECK #1)
 - UPDATED ROAD EXCEPTION REQUEST TABLE TO REDUCE REDUNDANT LINE ITEMS
 - WIDENED ROAD TO MAXIMUM EXTENT PRACTICAL WITHOUT ENCRoACHING IN ADJACENT CROSS SLOPES >50%

DATE: 09/24/16 ISSUE: PERMIT SET
05/16/17 PLAN CHECK
12/18/17 PLAN CHECK

SHEET
UP 2.4



PLAN VIEW

ONLY DRIVEWAY GRADING IMPROVEMENTS SHOWN. FOR SITE GRADING PLAN SEE SHEETS UP 5.0 & UP 5.1

DRIVEWAY SURFACE HATCH LEGEND

- EXISTING PAVEMENT
- PROPOSED PAVEMENT/PAVING EXTENTS
- PROPOSED GRAVEL SHOULDER

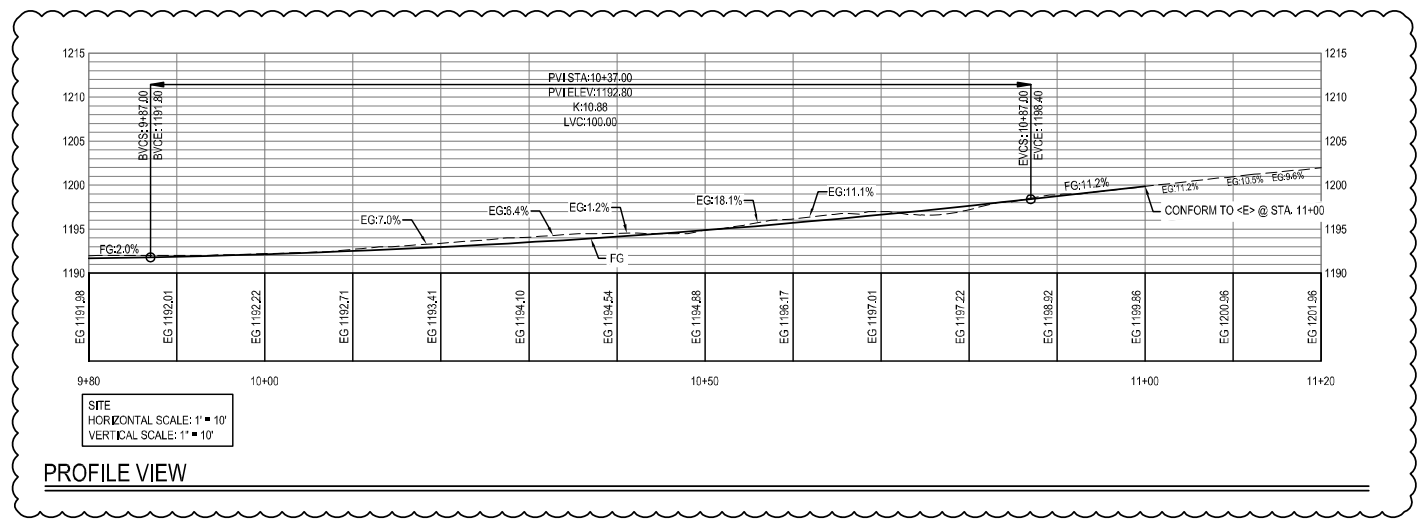

PROFILE VIEW

Plans to Accompany Road Exception Request, Rev 1, 01/08/2018

REVISIONS	
△ 05/16/17	NO CHANGES THIS SHEET
△ 12/18/17	PREVIOUSLY SHEET UP 2.2 REDUCED LENGTH REQUIRED TO CONFORM TO <E> DRIVEWAY TO RESIDENCE. PREVIOUSLY STA. 12+35, NOW STA. 11+00

THE USER OF THESE DOCUMENTS ACCEPTS ALL RESPONSIBILITIES AND LIABILITIES FOR THE USE OF THESE DOCUMENTS AND TO BE BOUND BY THE TERMS AND CONDITIONS OF THE LICENSE AGREEMENT. THE USER OF THESE DOCUMENTS ACCEPTS ALL RESPONSIBILITIES AND LIABILITIES FOR THE USE OF THESE DOCUMENTS AND TO BE BOUND BY THE TERMS AND CONDITIONS OF THE LICENSE AGREEMENT. THE USER OF THESE DOCUMENTS ACCEPTS ALL RESPONSIBILITIES AND LIABILITIES FOR THE USE OF THESE DOCUMENTS AND TO BE BOUND BY THE TERMS AND CONDITIONS OF THE LICENSE AGREEMENT.

DELTA CONSULTING & ENGINEERING
OF ST. HELENA
1104 ADAMS STREET, SUITE 203, ST. HELENA, CALIFORNIA 94574
707-963-9456 + 707-963-8528 FAX

USE PERMIT
PLAN AND PROFILE

HARD SIX CELLARS
1755 S. FORK DIAMOND MOUNTAIN ROAD
CALISTOGA, CA 94515
APN: 020-100-014
PROJECT: N-116



DATE	REVISION
09/24/16	PERMIT SET
05/16/17	PLAN CHECK
12/18/17	PLAN CHECK

SHEET
UP 2.5

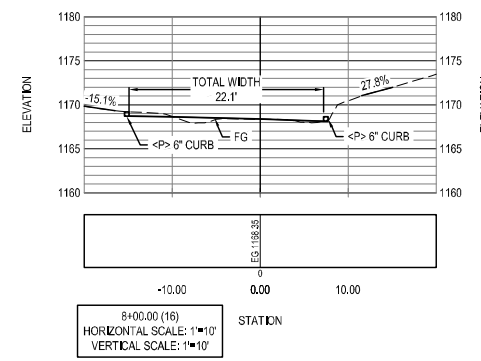
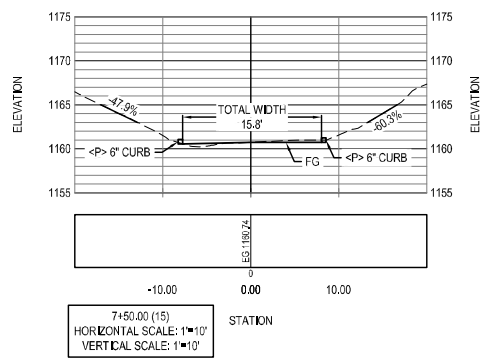
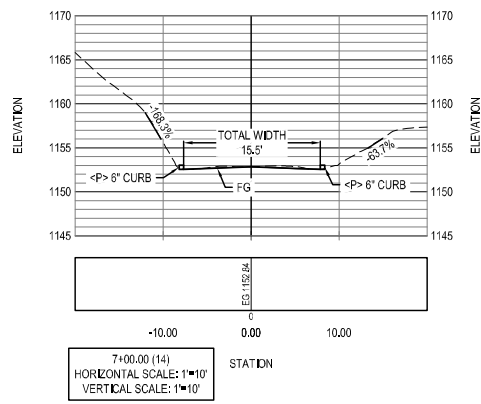
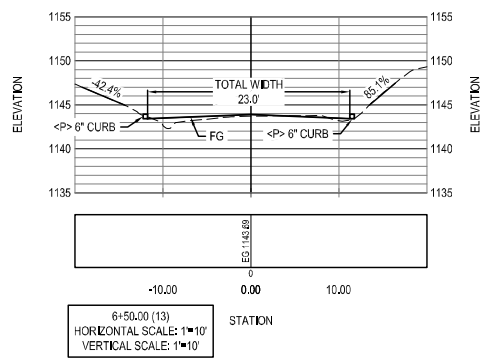
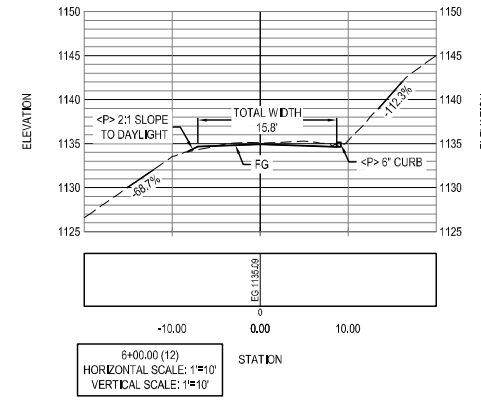
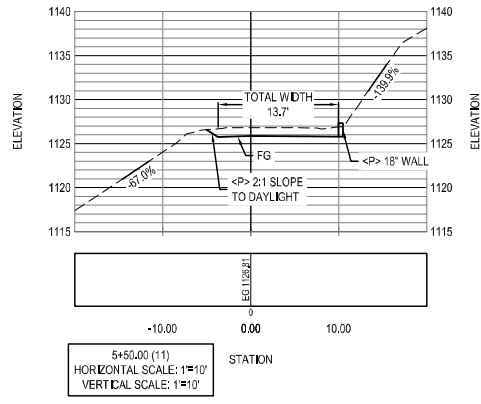
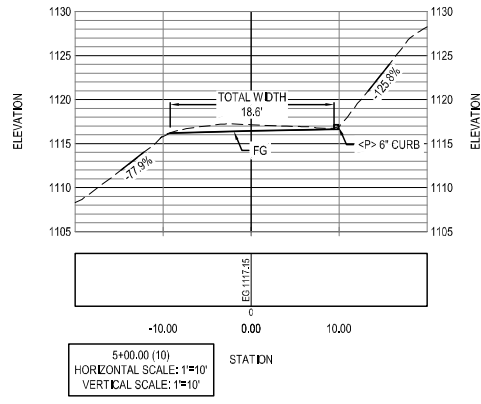
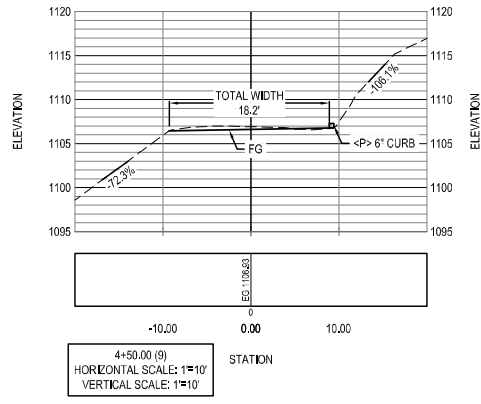
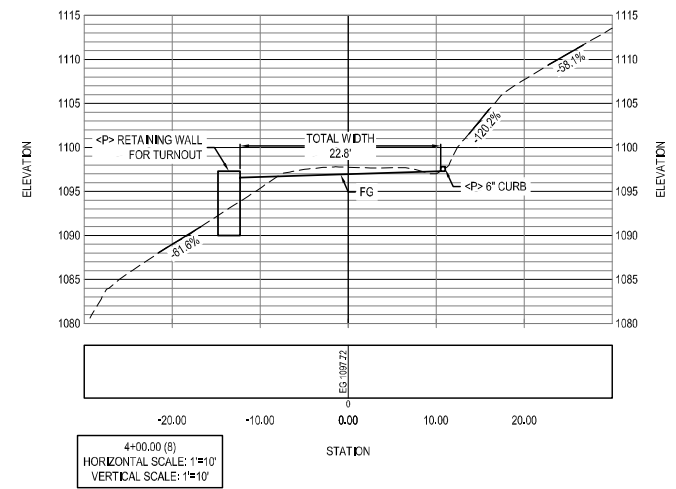
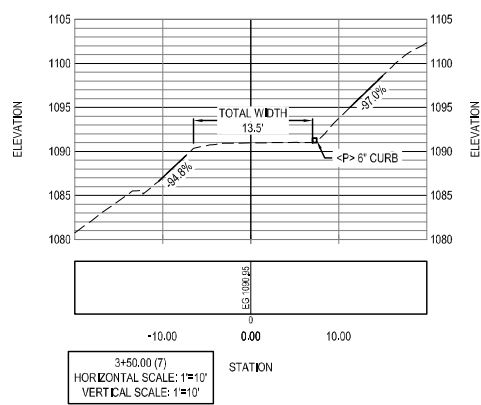
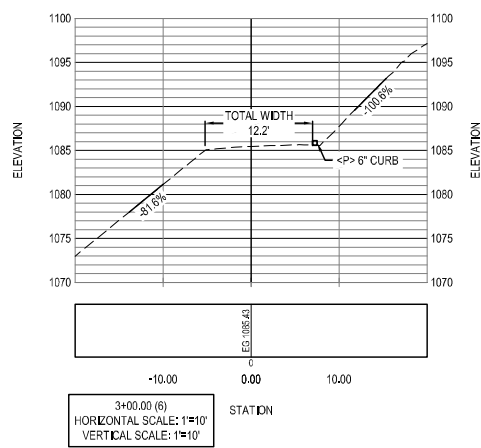
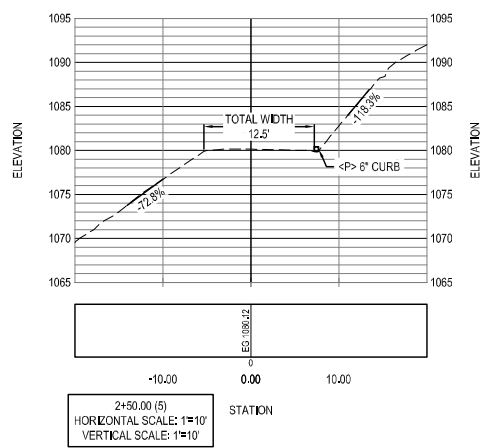
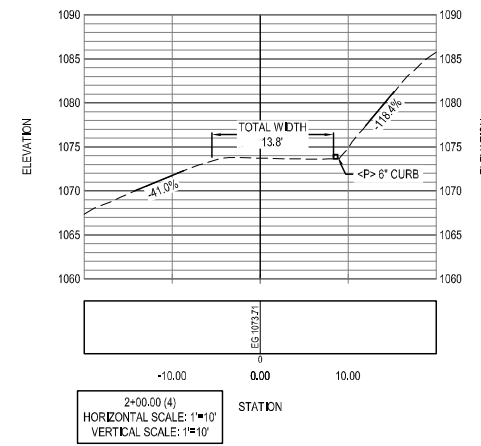
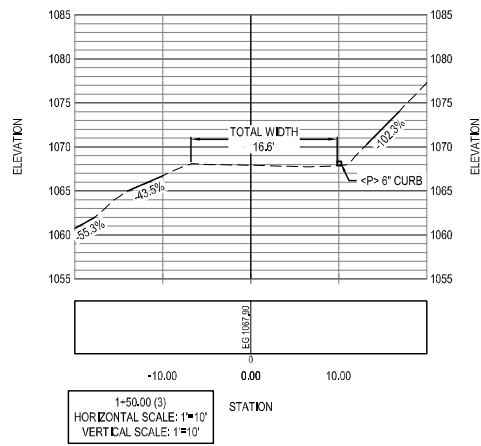
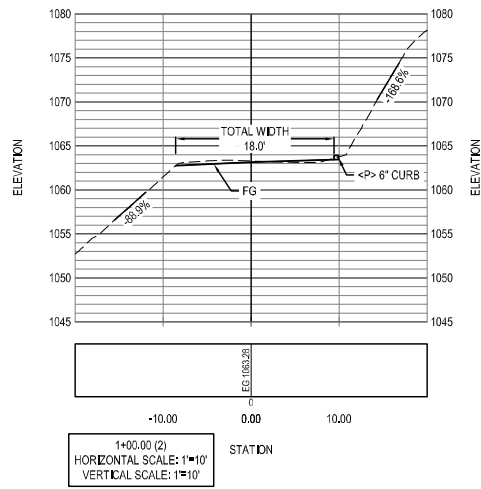
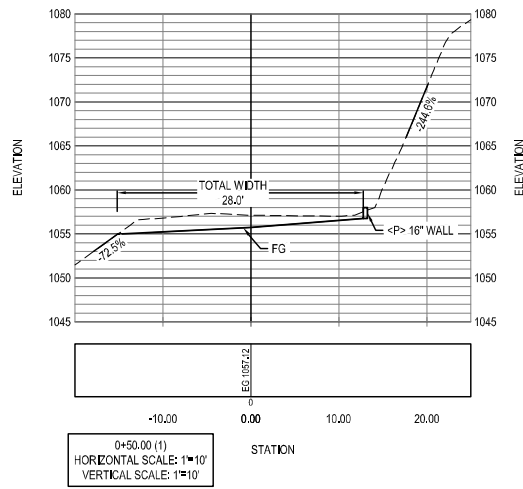

DRIVEWAY CROSS SECTIONS - ROAD EXCEPTION REQUEST AREAS

REVISIONS

12/18/17	NEW SHEET
----------	-----------

Plans to Accompany Road Exception Request, Rev 1, 01/08/2018

THE USER OF THESE DRAWINGS IS RESPONSIBLE FOR OBTAINING ALL NECESSARY PERMITS AND FOR THE DESIGN AND CONSTRUCTION OF THE PROJECT. THE USER SHALL BE RESPONSIBLE FOR THE PROTECTION OF THE PROJECT FROM DAMAGE AND FOR THE PROTECTION OF THE PROJECT FROM THE ELEMENTS OF NATURE. THE USER SHALL BE RESPONSIBLE FOR THE PROTECTION OF THE PROJECT FROM THE ELEMENTS OF NATURE. THE USER SHALL BE RESPONSIBLE FOR THE PROTECTION OF THE PROJECT FROM THE ELEMENTS OF NATURE.

DELTA CONSULTING & ENGINEERING OF ST. HELENA
1104 ADAMS STREET, SUITE 203, ST. HELENA, CALIFORNIA 94574
707-963-9486 • 707-963-8528 FAX

USE PERMIT
DRIVEWAY CROSS SECTIONS

HARD SIX CELLARS
1755 S. FORK DIAMOND MOUNTAIN ROAD
CALISTOGA, CA 94515
APN: 020-100-014
PROJECT: M-16



EVERY PERSON SHALL BE CALLED TO THE CALL USA AT 1-800-950-9500

DATE: 08/24/16
05/16/17
12/18/17

DESIGN: PERMIT SET
PLAN CHECK
PLAN CHECK

SHEET: UP 2.6