

“H”

## Viewshed Application and Landscape Plans

Anthem Winery P14-00320-MOD and Exception to Road and Street Standards,  
Variance P14-00321-VAR and Viewshed, and  
Agricultural Erosion Control Plan P14-00322-ECPA  
Planning Commission Hearing Date (Wednesday, October 3, 2018)

COUNTY OF NAPA  
PLANNING, BUILDING, AND ENVIRONMENTAL SERVICES

**VIEWSHED PROTECTION PROGRAM**

**APPLICATION PACKET**

1. Applicant's Checklist
2. Viewshed Protection Program Application
3. Indemnification Agreement
4. Application Completeness Requirements and Checklist
5. Adjoining Property Owner's List Requirements
6. Excerpts from Viewshed Protection Program Ordinance
7. Viewshed Protection Manual
8. Slope Determination Methodology

**NOTE:**

**PLEASE INCLUDE THREE COPIES OF  
ALL REQUIRED APPLICATION MATERIALS SUBMITTED.**



A Tradition of Stewardship  
A Commitment to Service

FILE # \_\_\_\_\_

**NAPA COUNTY**  
**PLANNING, BUILDING, AND ENVIRONMENTAL SERVICES**  
1195 THIRD STREET, SUITE 210, NAPA, CALIFORNIA, 94559 • (707) 253-4417

**APPLICATION FOR VIEWSHED PROTECTION PROGRAM**

FOR OFFICE USE ONLY

ZONING DISTRICT: \_\_\_\_\_ DATE SUBMITTED: \_\_\_\_\_  
TYPE OF APPLICATION: \_\_\_\_\_ DATE PUBLISHED: \_\_\_\_\_  
REQUEST: \_\_\_\_\_

Project Type: Structure \_\_\_ Driveway \_\_\_ Road \_\_\_ Reservoir \_\_\_ Mass Grading \_\_\_ Other \_\_\_\_\_

Other Permits Applied/Pending/Required:

ECP \_\_\_ Grading Permit \_\_\_ Use Permit \_\_\_ Variance \_\_\_

SDSDS \_\_\_ Groundwater Permit: \_\_\_

# \_\_\_\_\_ # \_\_\_\_\_ # \_\_\_\_\_ # \_\_\_\_\_ # \_\_\_\_\_ # \_\_\_\_\_

Review Agencies: PBES:  County Consultant: \_\_\_ Name/Contact: \_\_\_\_\_

Final Approval: PBES  Date: \_\_\_ / \_\_\_ / \_\_\_ Conditions: Yes \_\_\_ No \_\_\_

TO BE COMPLETED BY APPLICANT

(Please type or print legibly)

Applicant's Name: Anthem Winery and Vineyards, LLC

Telephone #: (707) 227 - 0722 Fax #: ( ) - \_\_\_\_\_ E-Mail: jarbuckle@sbcglobal.net

Mailing Address: 3454 Redwood Rd. Napa CA 94558  
No. Street City State Zip

Status of Applicant's Interest in Property: owners' business

Property Owner's Name: Justin and Julie Arbuckle, Trustees of the Arbuckle Family Trust

Telephone #: (707) 227- 0722 Fax #: ( ) - \_\_\_\_\_ E-Mail: jarbuckle@sbcglobal.net

Mailing Address: same as above  
No. Street City State Zip

Site Address/Location: same as above  
No. Street City State Zip

Assessor's Parcel #: 035-010-054 Parcel Size: 27.13 acres Development Area Size: 0.45 acres

Slope Range of Development Area: 0 % to 30 %

**(NOTE:** Contour map/survey is required for all development areas with an estimated slope of 15% or greater and for all road/driveway projects, Contour map must include all areas within 100' of the cut and fill edges. Percent slope shall be calculated and presented as whole numbers. (Please see attached Slope Determination Methodology)

I hereby certify that all the information contained in this application, including but not limited to, this application form, the supplemental information sheets, site plan, plot plan, cross sections/elevations, is complete and accurate to the best of my knowledge. I hereby authorize such investigations including access to County Assessor's Records as are deemed necessary by the County Planning Division for evaluation of this application and preparation of reports related thereto, including the right of access to the property involved.

 3/16/15  
Signature of Applicant Date

Julie Arbuckle, CEO Anthem Winery and Vineyards, LLC  
Print Name

 3/16/15  
Signature of Property Owner Date

Julie Arbuckle, Trustee of the Arbuckle Family Trust  
Print Name

TO BE COMPLETED BY PLANNING, BUILDING, AND ENVIRONMENTAL SERVICES

Application Fee: \$ \_\_\_\_\_ Receipt. No. \_\_\_\_\_ Received by: \_\_\_\_\_ Date: \_\_\_\_\_

## INDEMNIFICATION AGREEMENT

Pursuant to Chapter 1.30 of the Napa County Code, as part of the application for a discretionary land use project approval for the project identified below, Applicant agrees to defend, indemnify, release and hold harmless Napa County, its agents, officers, attorneys, employees, departments, boards and commissions (hereafter collectively "County") from any claim, action or proceeding (hereafter collectively "proceeding") brought against County, the purpose of which is to attack, set aside, void or annul the discretionary project approval of the County, or an action relating to this project required by any such proceeding to be taken to comply with the California Environmental Quality Act by County, or both. This indemnification shall include, but not be limited to damages awarded against the County, if any, and cost of suit, attorneys' fees, and other liabilities and expenses incurred in connection with such proceeding that relate to this discretionary approval or an action related to this project taken to comply with CEQA whether incurred by the Applicant, the County, and/or the parties initiating or bringing such proceeding. Applicant further agrees to indemnify the County for all of County's costs, attorneys' fees, and damages, which the County incurs in enforcing this indemnification agreement.

Applicant further agrees, as a condition of project approval, to defend, indemnify and hold harmless the County for all costs incurred in additional investigation of or study of, or for supplementing, redrafting, revising, or amending any document (such as an EIR, negative declaration, specific plan, or general plan amendment) if made necessary by said proceeding and if the Applicant desires to pursue securing approvals which are conditioned on the approval of such documents.

In the event any such proceeding is brought, County shall promptly notify the Applicant of the proceeding, and County shall cooperate fully in the defense. If County fails to promptly notify the Applicant of the proceeding, or if County fails to cooperate fully in the defense, the Applicant shall not thereafter be responsible to defend, indemnify, or hold harmless the County. The County shall retain the right to participate in the defense of the proceeding if it bears its own attorneys' fees and costs, and defends the action in good faith. The Applicant shall not be required to pay or perform any settlement unless the settlement is approved by the Applicant.

  
\_\_\_\_\_  
Applicant

3/16/15  
\_\_\_\_\_  
Date

\_\_\_\_\_  
Property Owner (if other than Applicant)

Anthem Winery  
\_\_\_\_\_  
Project Identification



**Anthem Winery  
Project Statement  
Amended Winery Use Permit  
*August 29, 2017***

Owner: Anthem Winery and Vineyards, LLC  
3454 Redwood Rd.  
Napa, CA 94558

Project Location: 3454 Redwood Rd.  
Napa, CA 94558  
APN: 035-470-046

General Plan: Agriculture, Watershed, Open Space (AWOS)  
Zoning: Agricultural Watershed (AW)

**Request:**

This request is to modify Anthem Winery and Vineyard, LLC's ("Anthem Winery") existing Winery Use Permit (#96006-UP) to: 1) build a larger winery facility; 2) increase wine production from 30,000 to 50,000 gallons; and 3) allow tours and tastings by appointment, retail sales and marketing events on a property located at 3454 Redwood Rd., Napa, California 94558 with an Assessor Parcel Number of 035-470-046 (the "subject property").

**Background:**

Anthem Winery is a woman-run winery in Napa, and is owned by Justin and Julie Arbuckle, Trustees of the Arbuckle Family Trust. They acquired the subject property in July of 2006 along with its existing winery facility and Winery Use Permit. The current use permit allows wine production of 30,000 gallons utilizing a large outdoor uncovered crush pad with outdoor fermentation tanks and an indoor wine production area of 1600 square feet. The 1996 application requested and received five tastings per week for wine trade. The subject property is 27.23 acres, 6 acres of which is planted to vineyards that Anthem Winery has been harvesting to produce its own wines since 2009. Additionally, Anthem Winery has an approved erosion control plan to plant an additional 2.29 acres of vineyards on the subject property, and adjoining parcel (3123 Dry Creek Rd.). Anthem Winery's adjoining parcels total 44.8 acres. Concurrent with this project, Anthem Winery is applying for an erosion control plan (ECP) to plant another 0.95 acres of vineyards on its two parcels.

In addition to the existing winery facility, there is an existing residence, two barns, and two accessory buildings on the subject property. There is also a 0.6 mile access road from Redwood Rd., across Redwood Creek, and to the residence and winery facility. The existing access road is 10 feet wide and has four turnouts.

The subject property is in an area with very few visible neighbors and is very difficult to see from the floor of the Napa Valley although parts of it are located near a minor ridgeline

overlooking Dry Creek Road. By building the production facility and caves into the hillside, the project's design minimizes the visibility and size of buildings to be located on the hilltop and the above-grade square footage required for wine production. The design also avoids removal of productive vineyards, requiring removal of just 0.2 acres of vines already in need of replanting, which will be replaced by planting 2.29 acres of vineyard already approved and the 0.95 acres of vineyards Anthem Winery now proposes in its ECP application.

At the County's request, Anthem Winery has had experts conduct traffic, noise, groundwater, and biological assessments. Each of these assessments have respectively concluded that the proposed use permit modification will have no significant impact on traffic, noise, groundwater, or the biological environment.

#### Project Description:

Winery: Anthem Winery proposes to build a new 10,833 square foot environmentally friendly winemaking facility (including two fermentation rooms, and a bottle room with a tasting area, a lab, and service rooms) into the hillside that it intends to be certified Napa Green. The winery, which has been designed by renowned Napa Valley architects Howard Backen and John Taft, will be divided into two buildings with a round bottle room in the center connecting the two buildings.

Instead of crushing and fermenting grapes outdoors on its existing large uncovered crush pad close the site's East property boundary line as it currently is permitted to do, Anthem Winery proposes to crush and ferment grapes in an indoor winemaking facility that is built back into the hillside, which will reduce noise and be less visible from the few neighboring parcels. This proposed winemaking facility will be over 200 feet away from the site's East boundary, whereas the existing permitted outdoor fermentation tanks and crush pad are located about 20 feet from the East boundary. The Arbuckles' residence is located about 300 feet from the proposed facility. When the existing winery was permitted in 1996, there were no residences on adjacent parcels within 1000 feet. (See page 2 of the Staff Report for 96006-UP dated October 16, 1996.) Now, the two nearest other residences are located approximately 900 feet (3 football fields) away from the proposed facility with ample existing evergreen screening between the proposed winery and those residences. Other residences in the vicinity are well over 1000 feet away.

This application requests to increase the winery's permitted production limit from 30,000 gallons to 50,000 gallons of wine per year. All of the grapes grown on the property will be crushed at the winery, as well the grapes from Anthem Winery's other Napa growers. Anthem Winery has no relationships with growers outside of Napa. Additionally, Anthem Winery intends to crush grapes of its winemaker's three other brands (currently Tor Kenward, Rudius, and Mayacama Farms), all of which are located in Napa and produce Napa wines. Activities related to all wines produced at the winery (regardless of brand) will comply with the proposed production levels, visitation, employees, and all use permit conditions.

Hospitality / Marketing Plan: Anthem Winery's tasting room and guest relations building is separate from the winery building. This smaller 1508 square foot structure will offer guests

the opportunity to taste Anthem Winery's wines in a natural setting that will be one of the most beautiful places to learn about wine in Napa Valley. Allowing visitation to Anthem Winery is crucial to its survival and ability to preserve the agricultural use of its parcels. It is the only realistic means by which Anthem Winery can increase its direct to consumer sales enough to remain a viable agricultural business. In addition, Anthem Winery's visiting customers will help support Napa Valley's local economy, and the viability and success of all the other small businesses that depend on visitors and direct to consumer sales. During construction of the winemaking facility, Anthem Winery requests to have a temporary tasting room at its existing winery while wine production is occurring at this existing facility. The temporary tasting room will be located in the existing 1600 square foot winery and 200 square foot adjacent outdoor event area, and will utilize the existing winery restroom and the parking spots next to the existing outdoor crush pad. No temporary office is proposed.

On premise consumption of wine is requested pursuant to the Evans Bill (AB2004). Hours of operation will be from 8:00 a.m. to 8:00 p.m. (10:00 a.m. to 6:00 p.m. tasting, and 8:00 a.m. to 8:00 p.m. non-harvest production) 7 days a week.

After discussions with neighbors, Anthem Winery already has made the substantial concession of agreeing to reduce its visitation numbers by 20% and special event numbers by 50%. Anthem Winery has therefore reduced its marketing plan directly in response to its neighbors' concerns and now proposes the following reduced visitation and event numbers:

- (1) Tours and tastings by prior appointment of 48 people per day on weekends, and 32 people per day on weekdays, for a maximum of 256 guests per week.
- (2) Marketing plan comprised of 2 food and wine events per month with a maximum of 30 people with no more than one of these events in the evening; ten events per year with a maximum of 100 people; one 200 person event per year; one 300 person event per year; and participation in the Wine Auction.

This substantially reduced visitation and event plan is reasonable and falls well within the visitation and event numbers granted to similar wineries in the past few years. The marketing events will occur inside and outside the winery and hospitality buildings and may include food service. Tours and tastings may occur on days that marketing events also occur. Evening marketing events (including clean-up) are proposed to cease by 10:00 p.m. on weekdays and by midnight on weekends. In addition, the three larger events will move indoors by 10 p.m. All marketing events will be by appointment or invitation. Parking will be in front of the winery, on site next to the vineyard blocks, and off site utilizing shuttle service.

Administration/Office Building: The administrative offices for the winery will be adjacent to the tasting room. This 1,724 square foot structure will include an office area for winery staff and owners, a conference room, and a commercial kitchen for events.

Caves: Anthem Winery will store the wine produced at the winery in barrels located in underground caves that connect to the back of the winery's bottle room. The caves for barrels will total 26,408 square feet, including two cave extensions, two 641 square foot cave tasting

rooms for guests, and two mechanical room spaces. Harvested rainwater will be stored in two large underground storage tanks that total an additional 2,645 square feet.

Parking: Employees and guests will park in front of and behind the winery. There will be 22 new parking spaces, including 1 new ADA parking space, 1 new parking space for electric vehicles with an electric vehicle charging station, and 1 new parking space for clean-air vehicles.

Construction Phases: Anthem Winery will complete construction in three phases. The first phase includes construction of the driveway, parking, septic system, winery production structures, bottle room, outdoor tasting area, and cave storage tanks for harvested rainwater. The second phase includes construction of the caves, and the third includes building the tasting room and office structures.

Employees: Anthem Winery will employ 7 full time and 5 part time employees.

Site Improvements: Anthem Winery proposes to use less water than it is currently permitted to use through substantial rainwater harvesting, recycling of winery process water, and installation of a water-efficient underground irrigation system. The proposed rainwater harvesting and reuse of process water will more than offset the proposed winery's total water use in an average year. Anthem Winery will also utilize three of its existing wells as project wells, but proposes to substantially reduce its already permitted groundwater use.

The entry road for the winery, tasting room and offices will be re-routed to the existing driveway at 3123 Dry Creek Rd., which has better visibility and access for emergency vehicles. The existing driveway at 3123 Dry Creek Rd. will be widened to two lanes and improved. The proposed driveway will provide a paved connection between Redwood Rd. and Dry Creek Rd. that will enable access to these roads and to neighboring parcels in emergencies such as fires, mudslides, and earthquakes - a valuable benefit to the community. Dry Creek Rd. is Level of Service D or below, which the project will not change.

Greenhouse Gas Reduction: Anthem Winery is committed to sustainable operations in its winery and vineyard, and recently achieved Napa Green certification of its vineyards. The proposed winery will install solar panels on the rooftops of the new winery buildings to supply electricity, and has incorporated numerous Best Management Practices and greenhouse gas reduction measures into its project plans, including plans for winery certification under Napa Green, processing wastewater onsite (i.e. no hold-and-haul), substantial rainwater harvesting and reuse of treated process wastewater to decrease groundwater use below what is already permitted, energy and water saving winery equipment, and installation of a water-efficient underground irrigation system. Additionally, employees and visitors will be encouraged to carpool or ride their bikes. A bike rack will be installed and bicycle maps will be available online to customers.

Variance Requested: Anthem Winery requests a variance from the setback of 300 feet from a private driveway serving another parcel on the grounds that: (1) Anthem Winery owns both parcels that will share the 3123 Dry Creek Rd. driveway, thus the driveway is not actually

shared with any neighbor and the setback's purpose of protecting neighbors who share a driveway serving a winery would not be served; (2) compliance with the setback would require removal of mature, productive vineyards without a corresponding public benefit; (3) the proposed structures within the 300 foot setback will be far less visible from the subject driveway than these structures would be if they were forced to move South to be outside the setback because any feasible location outside of it would require a large wine production warehouse to be built on top of the hillside and ridgeline where productive vineyards are located; and (4) the proposed structures and caves will use far less energy and produce significantly less greenhouse gas than an above grade wine production warehouse. For these reasons and those set forth in the Variance Application, Anthem Winery requests it be allowed to build the buildings located less than 300 feet from its 3123 Dry Creek Rd. driveway as shown on the plans submitted herewith.

Road and Street Standards: Anthem Winery requests an exception to the Road and Street Standards for winery driveway width on the grounds that: (1) The topography, property boundary lines, and/or existing mature native trees prohibit widening the Dry Creek Rd. driveway to 20 feet its entire length, but wherever physically possible, Anthem Winery will widen the driveway to 20 feet; and (2) Compared to the proposed Dry Creek Rd. driveway, Anthem Winery's existing, already approved 10 foot wide Redwood Rd. driveway has inferior lines of site, provides inferior access for emergency vehicles to the winery, and no emergency access between Redwood Rd. and Dry Creek Rd. Additionally, the proposed exception includes measures to provide the same level of access and safety that would be achieved by the Road and Street Standards.



B A C K E N  
G I L L A M  
K R O E G E R  
a r c h i t e c t s

August 22, 2018

Mr. Don Barrella  
Napa County – Planning, Building & Environmental Services  
1195 Third Street, Suite 210  
Napa, CA 94559

Re: Anthem Winery and Vineyards, LLC  
3454 Redwood Rd.  
Napa, CA 94558  
APN: 035-470-046

Project No: 201210

Dear Don Barrella,

This letter is to address the exterior materials for the Anthem Winery buildings.

The proposed buildings will have stained wood and natural stone siding, the roofs will either be Tesla solar roof tiles or corrugated metal with low reflectivity, the metal doors and window frames will be dark bronze metal, the wood doors will be brown or tan, and the integral color board formed concrete walls will be grey in color. The planned color scheme for all of these features will be earth tones in the range of the following color variations: greys, tans, browns, and dark bronze (metal doors and window frames only).

Sincerely,



Michael Boes

Project Manager – Backen Gillam Kroeger Architects

cc: Rob Anglin



These documents are the property of Claudia Schmidt Landscape Design. Any unauthorized use without the written consent of Claudia Schmidt is prohibited by law. Design for the responsibility of the documents if used whole or in part at any other location.

CLAUDIA SCHMIDT  
LANDSCAPE DESIGN

ANTHEM WINERY AND  
VINEYARDS, LLC  
3123 Dry Creek Road  
Napa, California 94558

Date	6/25/2018
Drawn By	CSL
Checked By	CSLD
Project No.	
Date	10/30/15
Issue	USE PERMIT
06/05/18	USE PERMIT RESUB'L

PLANTING PLAN

SCALE AS NOTED

Sheet **L2.1**  
of 1

PLANT SCHEDULE

TREES	QTY	BOTANICAL NAME	COMMON NAME	CONT	WELO
MOR FRU	16	MORUS ALBA "FRUITLESS"	FRUITLESS MULBERRY	36" BOX	MODERATE
OLE SEV	8	OLEA EUROPAEA "SEVILLANO"	OLIVE	FIELD DUG	VERY LOW
QUE AGR	12	QUERCUS AGRIFOLIA	COAST LIVE OAK	72" BOX	VERY LOW
SHRUBS	QTY	BOTANICAL NAME	COMMON NAME	CONT	WELO
ARB MAR	8	ARBUTUS X "MARINA"	ARBUTUS MULTI-TRUNK	48" BOX	LOW
ARC BAK	42	ARCTOSTAPHYLOS BAKERI "LOUIS EDMUNDS"	LOUIS EDMUNDS MANZANITA	5 GAL	LOW
ARC HUR	26	ARCTOSTAPHYLOS MANZANITA "DR. HURD"	DR. HURD MANZANITA	24" BOX	LOW
CEA YAN	13	CEANOTHUS GRISEUS HORIZONTALIS "YANKEE POINT"	CALIFORNIA LILAC	5 GAL	LOW
FRUIT TREES	QTY	BOTANICAL NAME	COMMON NAME	CONT	WELO
FRU TBD	2	FRUIT TREE TBD	FRUIT TREE TO BE DETERMINED	B & B	MODERATE
PERENNIALS	QTY	BOTANICAL NAME	COMMON NAME	CONT	WELO
AGA BLU	93	AGASTACHE X "BLUE FORTUNE"	ANISE HYSSOP	1 GAL	LOW
AGA LIC	71	AGASTACHE RUPESTRIS "LICORICE MINT"	HYSSOP	1 GAL	LOW
ERI KAR	184	ERIGERON KARVINSKIANUS	SANTA BARBARA DAISY	1 GAL	LOW
NEP BLU	30	NEPETA X FRAASSENII "BLUE WONDER"	CATMINT	1 GAL	LOW
PER SPI	128	PEROVSKIA ATRIPLICIFOLIA "BLUE SPIRES"	RUSSIAN SAGE	5 GAL	LOW
SAL MID	321	SALVIA LEUCANTHA "MIDNIGHT"	MEXICAN BUSH SAGE	5 GAL	LOW

LANDSCAPED AREA: 36,070 SQ. FT.

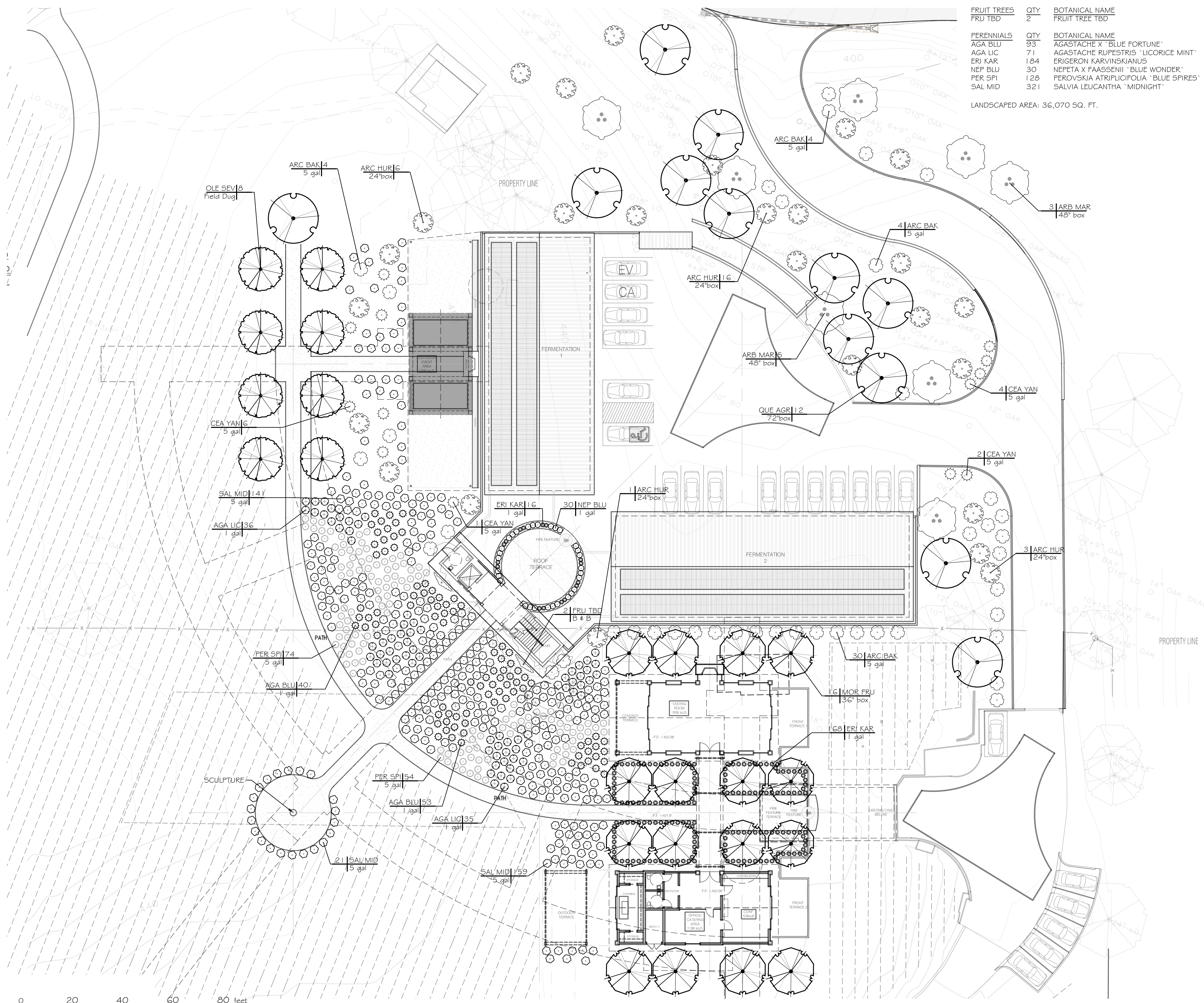

1 PLANTING PLAN  
SCALE: 1" = 20'

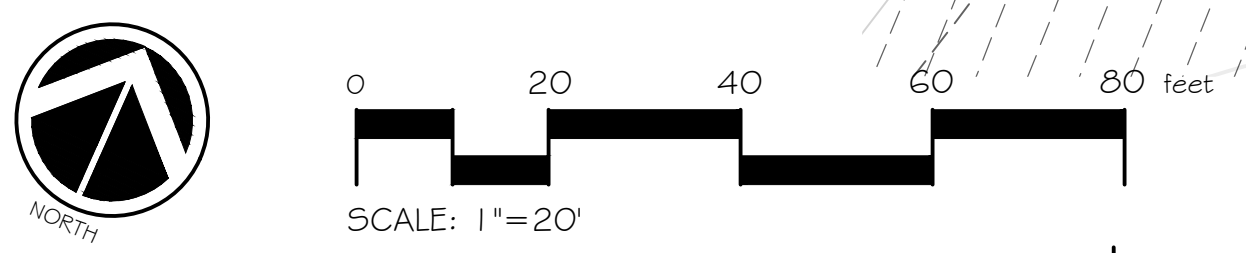



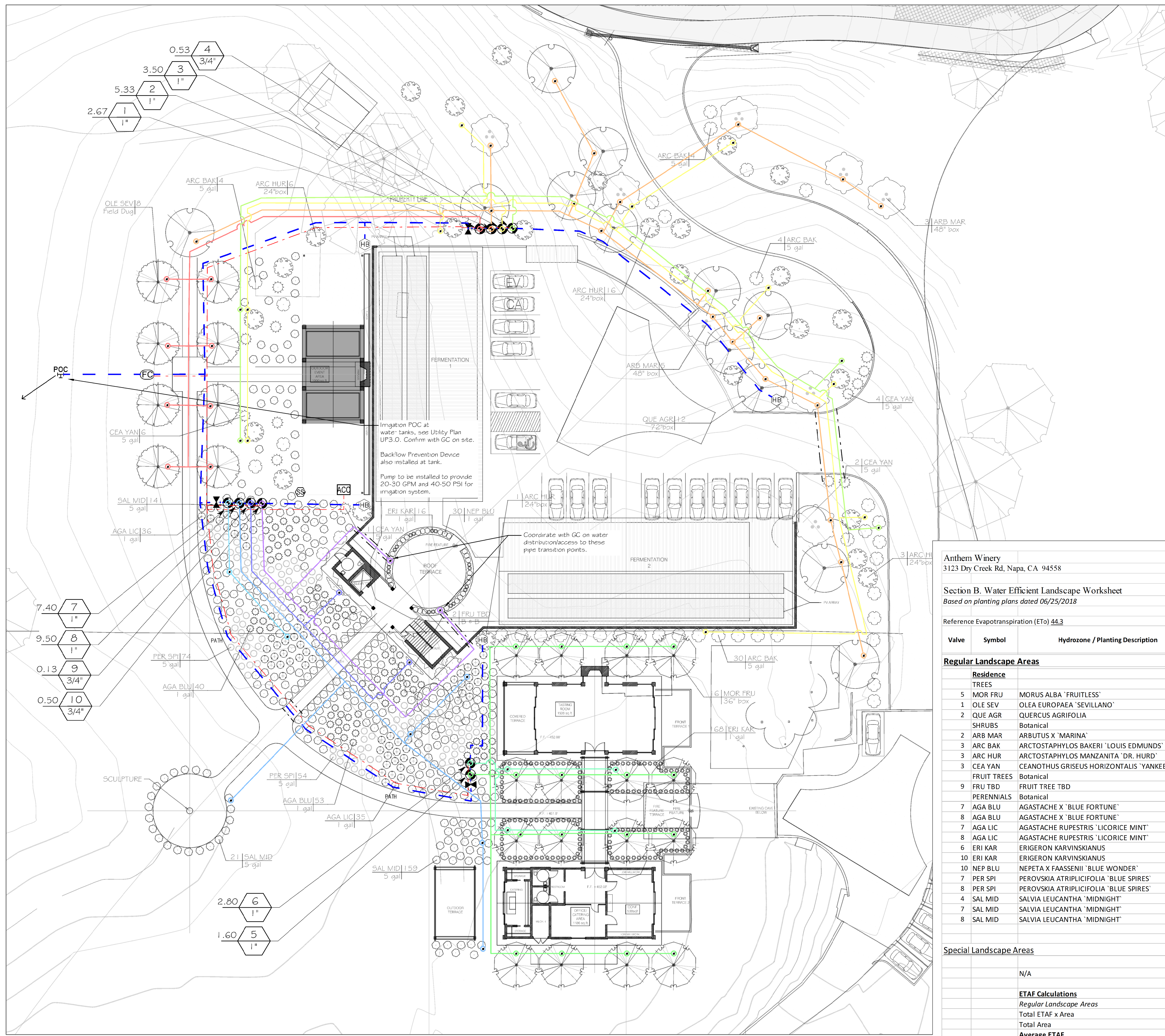

**IRRIGATION SCHEDULE**

SYMBOL	MANUFACTURER/MODEL/DESCRIPTION
*	Pipe Transition Point - From Below-Grade PVC Pipe to Above-Grade Drip Tube
⊖	Electric Remote Control Valve, typ.
HB	F hose Bibb (design and locat on to be approved by Landscape Architect)
X	Shut Off Valve - PVC Ball Valve at each Valve Assembly Grouping with Remote
ACC	Hunter ACC Outdoor Modular Controller with Remote. Metal Cabinet.
SS	Hunter Solar-Sync Solar, rain freeze sensor with outdoor interface, connects to Hunter PCC, Pro-C, and I-Core Controllers, install as noted. Includes 10 year lithium battery and rubber module cover, and gutter mount bracket. Wired.
FC	Hunter FLDW-CLK-100 Flow Sensor SOV with Interface Panel, 1" Schedule 40 Sensor Body, 24 VAC, 2 amp, install Interface Panel as required. Serves as meter for Irrigation System.
BF	Backflow Prevention device, already installed at tanks
---	Main line - 2" Sch. 40 PVC
---	Lateral Line - 5ch. 40 PVC
---	Chase - 4" Sch. 40 PVC - Qty as needed
---	Controller Wire in 1" Conduit for Two-Wire system
⊖	Valve Callout
#	Valve Number
→	Valve Flow
⊖	Valve Size

Anthem Winery  
3123 Dry Creek Rd, Napa, CA 94558

**Section B. Water Efficient Landscape Worksheet**  
Based on planting plans dated 06/25/2018

Reference Evapotranspiration (ET<sub>0</sub>) 44.3

Valve	Symbol	Hydrozone / Planting Description	WUCOLS	Zone Plant Factor	Irrigation Method	Irrigation Efficiency (IE)	ETAF (PF/IE)	Landscape Area (sq.ft)	ETAF x Area	Estimated Total Water Use (ETWU)	Qty	Size	
<b>Regular Landscape Areas</b>													
<b>Residence</b>													
<b>TREES</b>													
5	MOR FRU	MORUS ALBA 'FRUITLESS'	MODERATE	0.6	Drip	0.81	0.74	5600	4,148	104,932	16	36" BOX	
1	OLE SEV	OLEA EUROPAEA 'SEVILLANO'	VERY LOW	0.1	Drip	0.81	0.12	2800	346	8,744	8	FIELD DUG	
2	QUE AGR	QUERCUS AGRIFOLIA	VERY LOW	0.1	Drip	0.81	0.12	4800	593	14,990	12	72" BOX	
<b>SHRUBS</b>													
2	ARB MAR	ARBUTUS X 'MARINA'	LOW	0.3	Drip	0.81	0.37	2000	741	18,738	8	48" BOX	
3	ARC BAK	ARCTOSTAPHYLOS BAKERI 'LOUIS EDMUNDS'	LOW	0.3	Drip	0.81	0.37	1260	467	11,805	42	5 GAL	
3	ARC HUR	ARCTOSTAPHYLOS MANZANITA 'DR. HURD'	LOW	0.3	Drip	0.81	0.37	1560	578	14,615	26	24" BOX	
3	CEA YAN	CEANOTHUS GRISEUS HORIZONTALIS 'YANKEE POINT'	LOW	0.3	Drip	0.81	0.37	390	144	3,654	13	5 GAL	
<b>FRUIT TREES</b>													
9	FRU TBD	FRUIT TREE TBD	MODERATE	0.6	Drip	0.81	0.74	60	44	1,124	2	B & B	
<b>PERENNIALS</b>													
7	AGA BLU	AGASTACHE X 'BLUE FORTUNE'	LOW	0.3	Drip	0.81	0.37	400	148	3,748	40	1 GAL	
8	AGA BLU	AGASTACHE X 'BLUE FORTUNE'	LOW	0.3	Drip	0.81	0.37	530	196	4,966	53	1 GAL	
7	AGA LIC	AGASTACHE RUPESTRIS 'LICORICE MINT'	LOW	0.3	Drip	0.81	0.37	360	133	3,373	36	1 GAL	
8	AGA LIC	AGASTACHE RUPESTRIS 'LICORICE MINT'	LOW	0.3	Drip	0.81	0.37	350	130	3,279	35	1 GAL	
6	ERI KAR	ERIGERON KARVINSKIANUS	LOW	0.3	Drip	0.81	0.37	1176	436	11,018	168	1 GAL	
6	ERI KAR	ERIGERON KARVINSKIANUS	LOW	0.3	Drip	0.81	0.37	112	41	1,049	16	1 GAL	
10	NEP BLU	NEPETA X FAASSENII 'BLUE WONDER'	LOW	0.3	Drip	0.81	0.37	300	111	2,811	30	1 GAL	
7	PER SPI	PEROVSKIA ATRIPLICIFOLIA 'BLUE SPIRES'	LOW	0.3	Drip	0.81	0.37	740	274	6,933	74	5 GAL	
8	PER SPI	PEROVSKIA ATRIPLICIFOLIA 'BLUE SPIRES'	LOW	0.3	Drip	0.81	0.37	540	200	5,059	54	5 GAL	
4	SAL MID	SALVIA LEUCANTHA 'MIDNIGHT'	LOW	0.3	Drip	0.81	0.37	240	89	2,249	16	5 GAL	
7	SAL MID	SALVIA LEUCANTHA 'MIDNIGHT'	LOW	0.3	Drip	0.81	0.37	1695	628	15,880	113	5 GAL	
8	SAL MID	SALVIA LEUCANTHA 'MIDNIGHT'	LOW	0.3	Drip	0.81	0.37	2880	1,067	26,982	192	5 GAL	
								<b>TOTALS:</b>	<b>27,793</b>	<b>10,513</b>	<b>265,948</b>		
<b>Special Landscape Areas</b>													
N/A													
<b>ETAF Calculations</b>													
<i>Regular Landscape Areas</i>													
Total ETAF x Area										10,513	ETWU Total = 265,948		
Total Area										27,793	Maximum Applied Water Allowance (MAWA)* = 343,513		
Average ETAF										0.38			
*MAWA calculation: 44.3*0.62*(0.45*27,793)													
<i>All Landscape Areas</i>													
Total ETAF x Area										10,513			
Total Area										27,793			
Average ETAF										0.38			

CLAUDIA SCHMIDT  
LANDSCAPE DESIGN

ANTHEM WINERY AND  
VINEYARDS, LLC  
3123 Dry Creek Road  
Napa, California 94558

Streamline  
irrigation design and compliance  
streamlinedc.com  
(707) 529-2633

Date	6/26/2018
Drawn By	CBL
Checked By	CSLD
Project No.	
Date	10/30/15
Issue	USE PERMIT
06/03/16	USE PERMIT RESUB-L

IRRIGATION PLAN  
AND WELO CALCS

SCALE: AS NOTED

Sheet IRI.0  
of 2

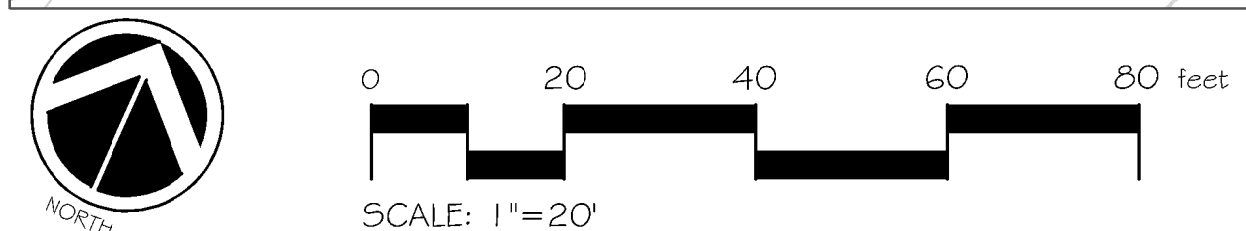



**Irrigation Notes**

- These irrigation drawings are diagrammatic and indicative of the work to be installed. All piping, valves and other irrigation components may be shown within paved areas for graphic clarity only and are to be installed within planting areas. Due to the scale of the drawings, it is not possible to indicate all offsets, fittings, sleeves, conduit and other items which may be required. Notify any coordinate irrigation contract work with applicable contractors for the location and installation of pipe, conduit or sleeves.
- The intent of this irrigation system is to conserve resources while providing a minimum amount of water required to sustain good plant health.
- It is the responsibility of the maintenance contractor and/or owner to program the irrigation controller to provide the minimum amount of water needed to sustain good plant health. This includes making adjustments to the irrigation program for seasonal weather changes, plant material, water requirements, mounds, slopes, sun, shade, wind exposure and growth over time.
- It is the responsibility of a licensed electrical contractor to provide 120 volt A.C. (2.5 amp demand per controller) electrical service to the controller location. It is the responsibility of the irrigation contractor to coordinate the electrical service stub-out to the controller. Provide proper grounding per controller manufacturer's instructions and in accordance with local codes.
- Provide the irrigation controller with its own independent low voltage common ground wire.
- Unless otherwise indicated, well contractor to provide a dedicated 2" service line with a minimum of 25 GPM and 40 PSI with a separate meter or sub-meter.
- Irrigation controller shall be weather- or moisture-based controller that automatically adjusts irrigation in response to changes in plants' needs as weather conditions change. Weather-based controllers without integral rain sensors or communication systems that account for local rainfall shall have a separate rain sensor which communicates with the controller. Soil moisture-based controllers are not required to have rain sensor input.
- Install new batteries in the irrigation controller to retain program information during power failures. Owner/maintenance contractor to check twice annually and replace when necessary, no less frequent than two years.
- Schedule a meeting which includes the maintenance contractor, the owner (or owner's representative) and the irrigation contractor at the site for instruction on the proper programming and operation of the irrigation controller. Irrigation contractor to provide owner's manual and as-built plans.
- Splicing of low voltage wires is permitted in valve boxes only. Leave a 24" long, 1" diameter coil of excess wire at each splice. Tape wires together every ten feet. Do not tape wires together where contained within sleeving or conduit.
- Install black plastic valve boxes with non-hinged cover marked "irrigation."
- Hose bib and irrigation valve locations are diagrammatic. Install remote control valve boxes 12" from walk, curb, lawn header board, building or landscape feature. At multiple valve box groups, install each box 12" apart. Hose bib and valve box locations to be approved by landscape architect.
- A ballgate valve shall be installed to isolate each irrigation valve or group of valves located together. Gate valve size shall be the same as the main line.
- Flush and adjust irrigation outlets and nozzles for optimum performance and to not allow overspray onto walks, roadways and/or buildings. Select the best degree of the arc and radius to fit the existing site conditions and throttle the flow control at each valve to obtain the optimum operating pressure for each control zone.
- Set sprinkler heads perpendicular to finish grade.
- Locate emitter outlets and bubblers on uphill side of plant or tree.
- At locations where low sprinkler head drainage will cause erosion and/or excess water, install a pop-up body with integral check valve. Install a spring loaded check valve on bubbler and emitter users where required.
- Where it is necessary to excavate adjacent to existing trees, use caution to avoid injury to trees and tree roots. Excavate by hand in areas where 2 inch diameter and larger roots occur. Backfill trenches adjacent to tree within 24 hours. Where this is not possible, shade the side of the trench adjacent to the tree with wet burlap or canvas.
- The sprinkler system design is based on the minimum operating pressure shown on the irrigation drawings. Verify water pressure prior to construction. Report any difference between the water pressure indicated on the drawings and the actual pressure reading at the irrigation point of connection to the owner's authorized representative.
- Pipe sizing shown on the drawings is typical. As changes in layout occur during staking and construction the size may need to be adjusted accordingly.
- The irrigation contractor shall be responsible for minor changes in the irrigation layout due to obstructions not shown on the irrigation drawings such as lights, fire hydrants, signs, electrical enclosures, unforeseen underground utilities or boulders, etc.

"I have complied with the criteria of the Model Water Efficient Landscape Ordinance and applied them accordingly for the efficient use of water in the irrigation design plan."

*Lindsay Menget*

-Lindsay Menget, Streamline Irrigation Design and Compliance

- FINISH GRADE
- QUICK-COUPLING VALVE ONE-PIECE BODY WITH 1 INCH INLET AND 1 1/4 INCH KEY OUTLET
- VALVE BOX WITH COVER
- 3/4" MINUS WASHED GRAVEL
- PVC SCH 80 NIPPLE- 1" (LENGTH AS REQUIRED)
- PVC SCH 40 STREET ELL-1"
- BRICK SUPPORTS (2)
- PVC SCH 40 STREET ELL-1"
- PVC SCH 40 TEE OR ELL X 1"
- PVC MAINLINE PIPE
- PVC SCH 40 ELL-1"

NOTE:  
1. FURNISH FITTINGS AND PIPING NOMINALLY SIZED IDENTICAL TO NOMINAL QUICK-COUPLING VALVE INLET SIZE.

**1 QUICK COUPLING VALVE**  
NOT TO SCALE

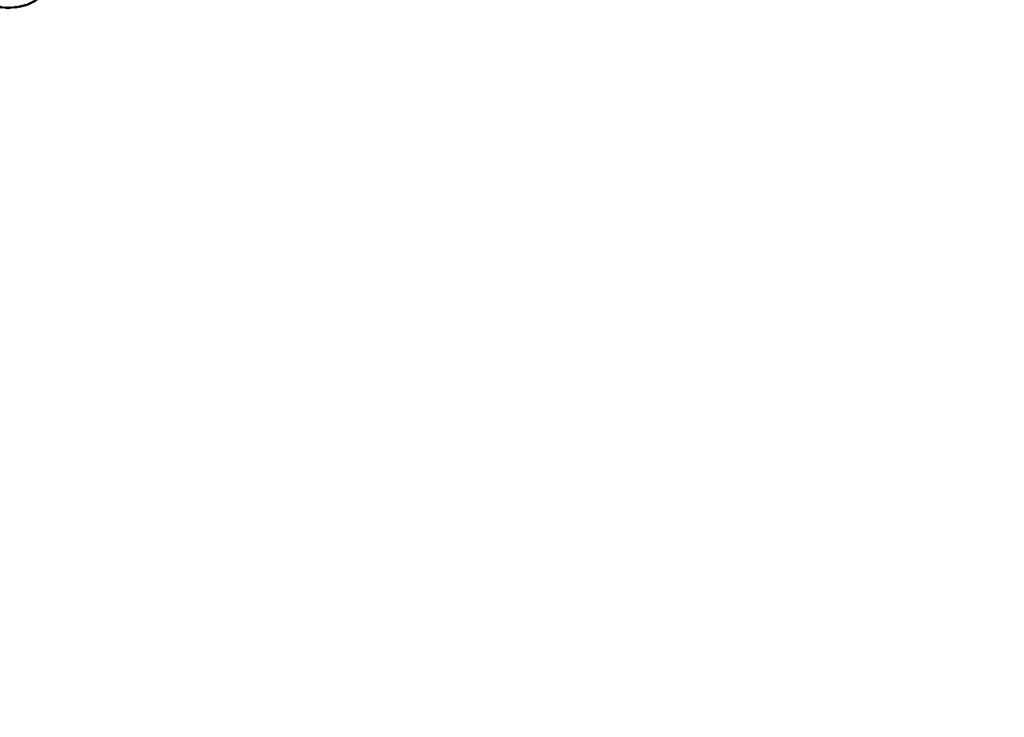

EMITTER CHART - NETAFIM PC 1 GPH EMITTER								
Container Size	1 gal	5 gal	15 gal/24" box	36" box	48" box	60" box	72" box	Field Dig
Qty Emitters	1	2	4	6	10	14	20	20'

\*Distribute emitters on 2 drip rings

**3 EMITTER CHART**  
NOT TO SCALE

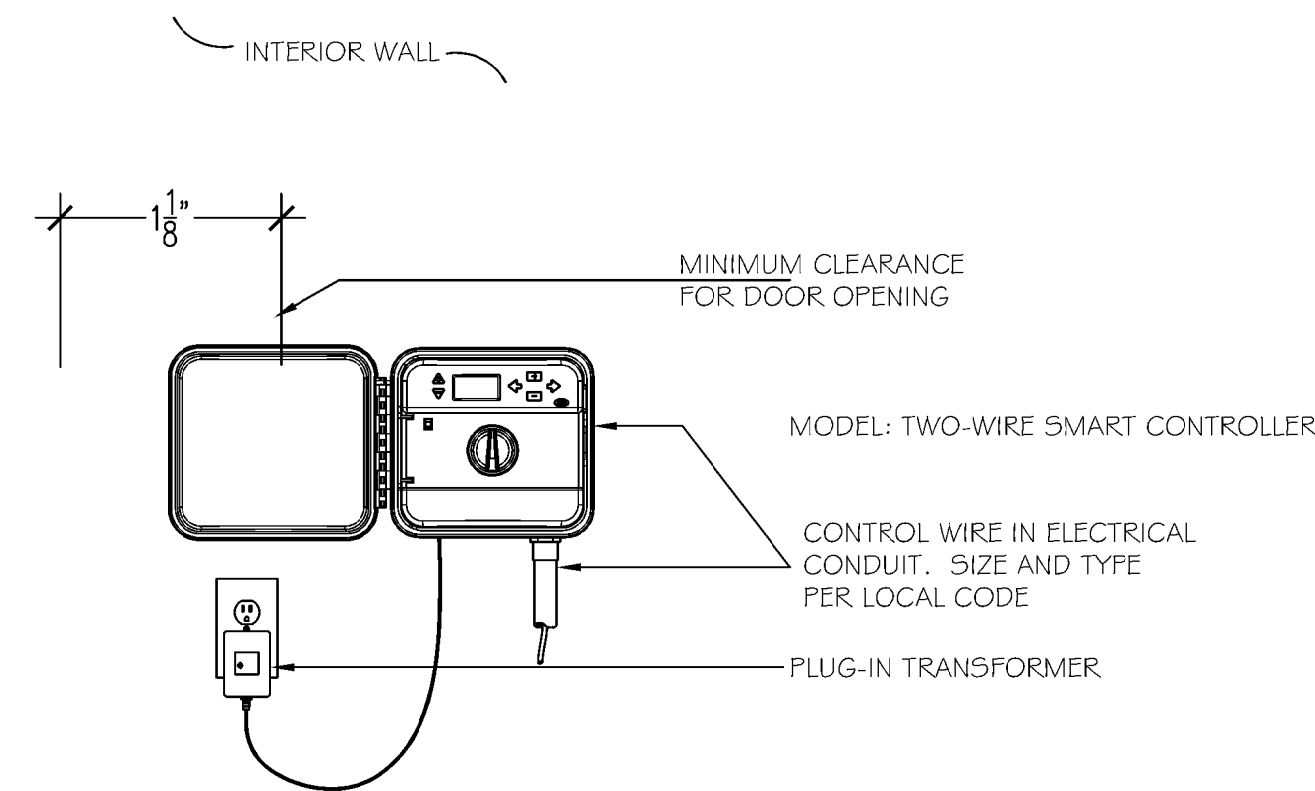

MOUNT CONTROLLER WITH LCD SCREEN AT EYE LEVEL. PLUG-IN TRANSFORMER SHALL BE CONNECTED TO GROUNDED 110 VAC OUTLET.

**5 CONTROLLER**  
NOT TO SCALE

- Imtrol 700-1/L-LS, 700-1.5/L-LS, 700-2/L-LS electric control valve or equal
- Finish Grade
- Valve Box, black
- PVC Male Adapter
- Waterproof wire connectors
- PVC lateral line-angle to proper depth with 450 ells
- Common red brick (optional, 4 required)
- 3/8" Gravel, 1-1/2" deep
- PVC Schedule 80 nipple (6" long)
- PVC Schedule 80 Union
- Hardware Cloth for gopher protection, typ.
- Common and control wires to controller location
- Pressure main line piping with main line fitting (depth as required)

NOTE:  
1. This drawing is provided for reference only. Individual project requirements and local codes may dictate differences in installation procedure that are not identified here.  
2. Refer to product literature for additional installation and adjustment information.

**2 VALVE ASSEMBLY**  
NOT TO SCALE

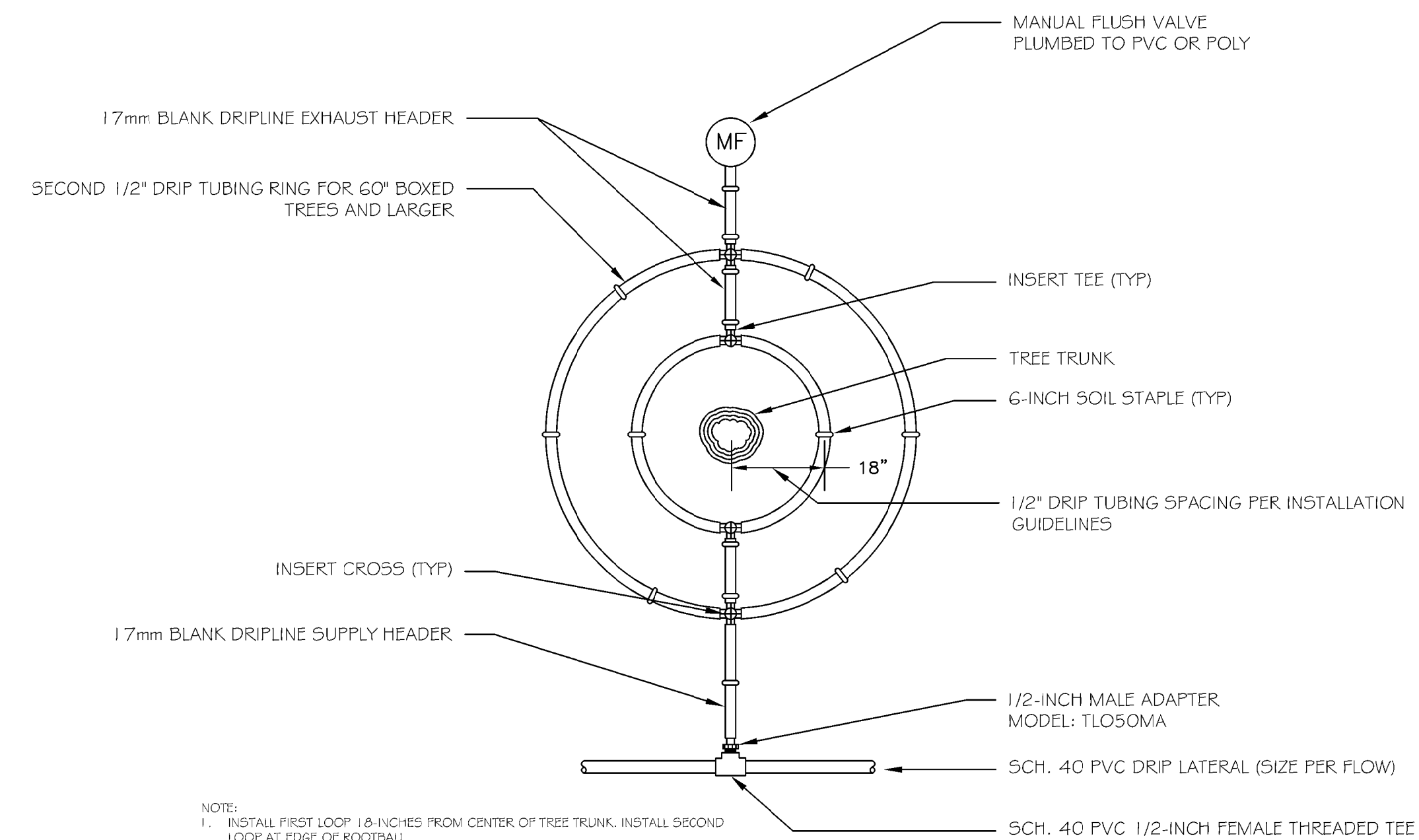

NOTE:  
1. INSTALL FIRST LOOP 1.8-INCHES FROM CENTER OF TREE TRUNK. INSTALL SECOND LOOP AT EDGE OF ROOTBALL.  
2. USE TORO 1/2" BLUE LINE DRIP HOSE OR EQUAL.  
3. SEE EMITTER CHART FOR QUANTITY OF EMITTERS PER CONTAINER SIZE.

**4 TREE RING DETAIL FOR 24" BOXED TREES AND LARGER**  
NOT TO SCALE

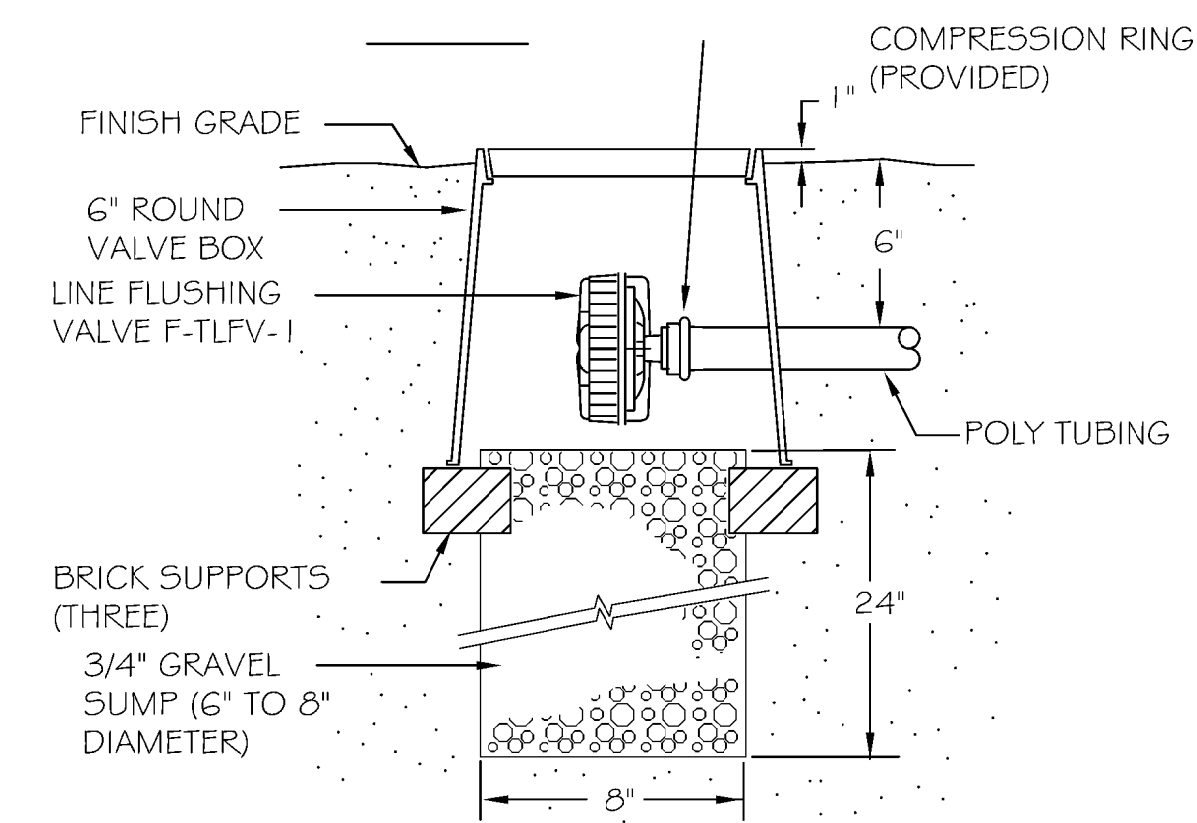

**6 DRIP LINE FLUSHING VALVE DETAIL**  
NOT TO SCALE

These documents are the property of Claudia Schmidt. Any reproduction or unauthorized use without the written consent is prohibited by law. Claudia Schmidt, Landscape Design, disclaims responsibility for the documents if used whole or in part at any other location.

**CLAUDIA SCHMIDT**  
**LANDSCAPE DESIGN**

**ANTHEM WINERY AND VINEYARDS, LLC**  
 3123 Dry Creek Road  
 Napa, California 94558

**Streamline**  
 irrigation design and compliance  
 streamlinedc.com  
 (707) 529-2633

Date	6/26/2018
Drawn By	CSL
Checked By	CSLD
Project No.	
Date	3/30/15
Issue	USE PERMIT
	USE PERMIT RESUB. 1

IRRIGATION NOTES AND DETAILS

SCALE: AS NOTED