

March 20, 2014

Kim Withrow  
Napa County PBES  
1195 Third Street, Room 210  
Napa, CA 94559-3001

RE:            Markham Vineyards Use Permit Assistance  
                  Project Number        2013171

Dear Mrs. Withrow:

As requested by Markham Vineyards, we evaluated the anticipated wastewater flows associated with the proposed Use Permit Modification to allow for an increase in production from 300,000 to 429,000 gallons wine year. Modifications to the existing marketing plan are not being proposed at this time. We evaluated the permitted capacity of the existing combined wastewater management system (CWMS) currently serving the winery to determine if it is adequate to serve the associated wastewater flows.

The existing CWMS treats wastewater generated from Markham Vineyards, Freemark Abby Winery (FMA), Culinary Institute of America (CIA), and Wine Country Inn (WCI), known collectively as the USERS. The CWMS is permitted by the San Francisco Bay Region Regional Water Quality Control Board (RWQCB) and Napa County Planning, Building and Environmental Services (PBES) to treat 16.07 million gallons per year (Mgal/yr) of combined sanitary and process wastewater.

Based on historical flow data and water conservation efforts at Markham Vineyards, the proposed increase in production is not anticipated to exceed the CWMS permitted discharge capacity. Therefore, improvements and/or expansion of the existing system are not being proposed with this Use Permit modification.

An overview of the existing CWMS is discussed in the enclosed wastewater feasibility study (WWFS). Please refer to the overall site plan for site and project features including building locations and locations of the existing CWMS.

To help with your review of this wastewater management system, the following items are included:

- Enclosure A: Existing Overall Site Plan  
Existing Combined Wastewater System Schematic
- Enclosure B: Combined Wastewater Management System Overview
- Enclosure C: Flow & Pond Aeration/HRT Calculations  
Original Design Calculations
- Enclosure D: 2003 RWQCB ROWD LETTER OF COMPLETENESS  
2003 ROWD (REVISED WDR)  
RWQCB WDR, ORDER NO. 98-064

Should you have any questions or need any additional information in regard to this WWFS, please do not hesitate to contact us your earliest convenience.

Sincerely,

Christina Nicholson  
Staff Engineer

Anu Shah, P.E.  
Principal

cc: Dave Flanary – Markham Vineyards  
Jeff Redding

MARKHAM VINEYARDS  
Project No. 2013171  
March 27, 2014

SUMMIT ENGINEERING, INC.  
Wastewater Feasibility Study  
BY: CN CHK: RR

---

ENCLOSURE A

EXISTING OVERALL SITE PLAN  
EXISTING COMBINED WASTEWATER SYSTEM SCHEMATIC

THIS DOCUMENT, AND THE IDEAS AND DESIGNS INCORPORATED HEREIN, AS AN INSTRUMENT OF PROFESSIONAL SERVICE, IS THE PROPERTY OF SUMMIT ENGINEERING, INC. AND IS NOT TO BE USED IN WHOLE OR IN PART, FOR ANY OTHER PROJECT WITHOUT THE WRITTEN AUTHORIZATION OF SUMMIT ENGINEERING, INC.

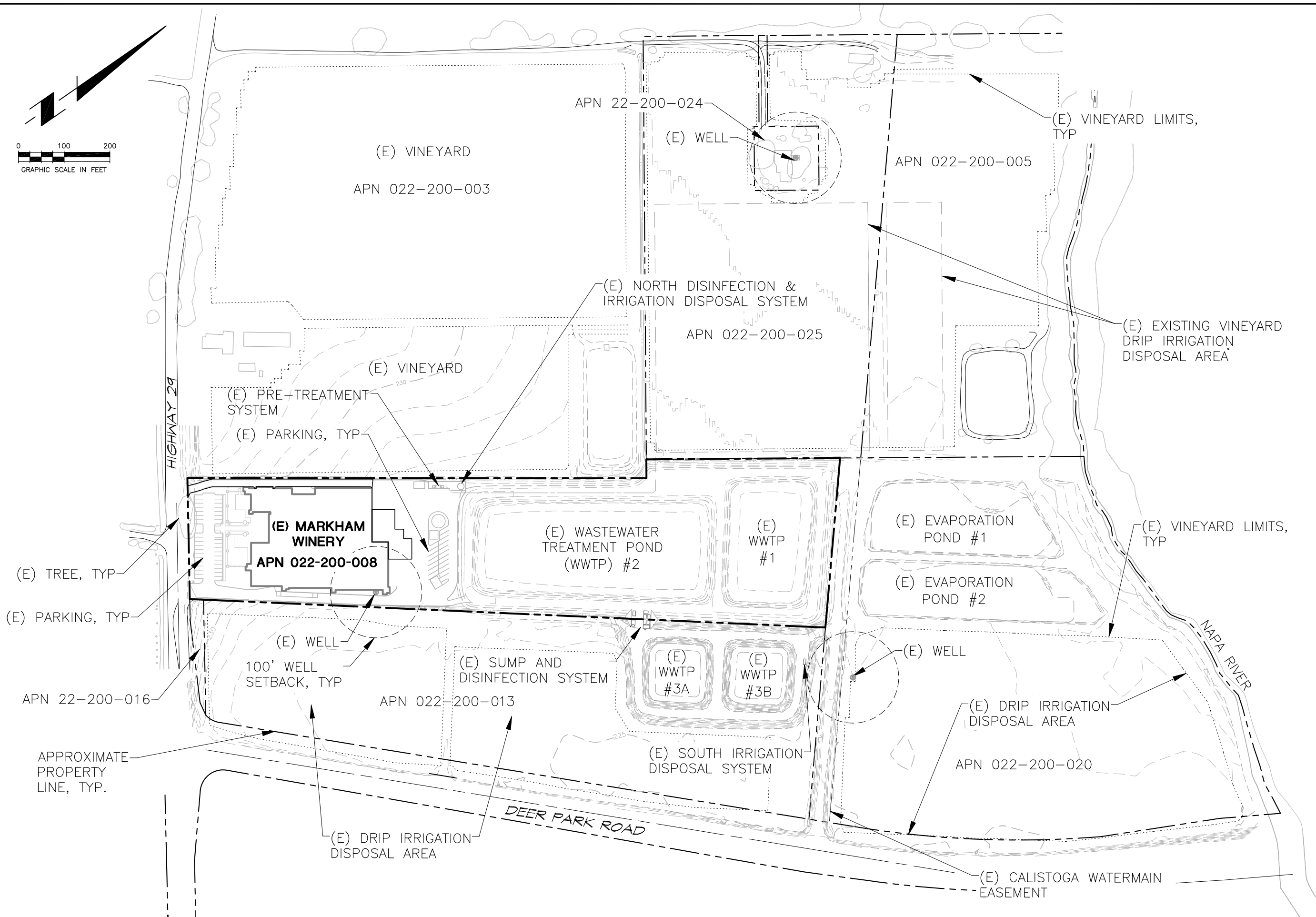
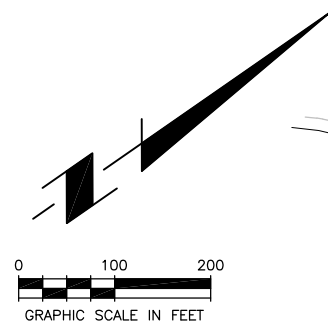

**SUMMIT**  
 Summit Engineering, Inc.  
 463 Aviation Blvd., Suite 200 • Santa Rosa, CA 95403  
 707-527-0775 • www.summit-sr.com

**MARKHAM VINEYARDS**  
 2812 ST. HELENA HWY  
 ST. HELENA, CA  
 APN 021-420-016

**USE PERMIT MODIFICATION**  
**COMBINED WASTEWATER TREATMENT SYSTEM**  
**SITE PLAN**

03-20-2014  
 UP SUBMITTAL

DATE: 02-06-2014  
 JOB NO: 2013171  
 SCALE: AS SHOWN  
 DRAWN: BL/CN  
 CHECKED: RR

SHEET  
**UP6**

FLOWCHART

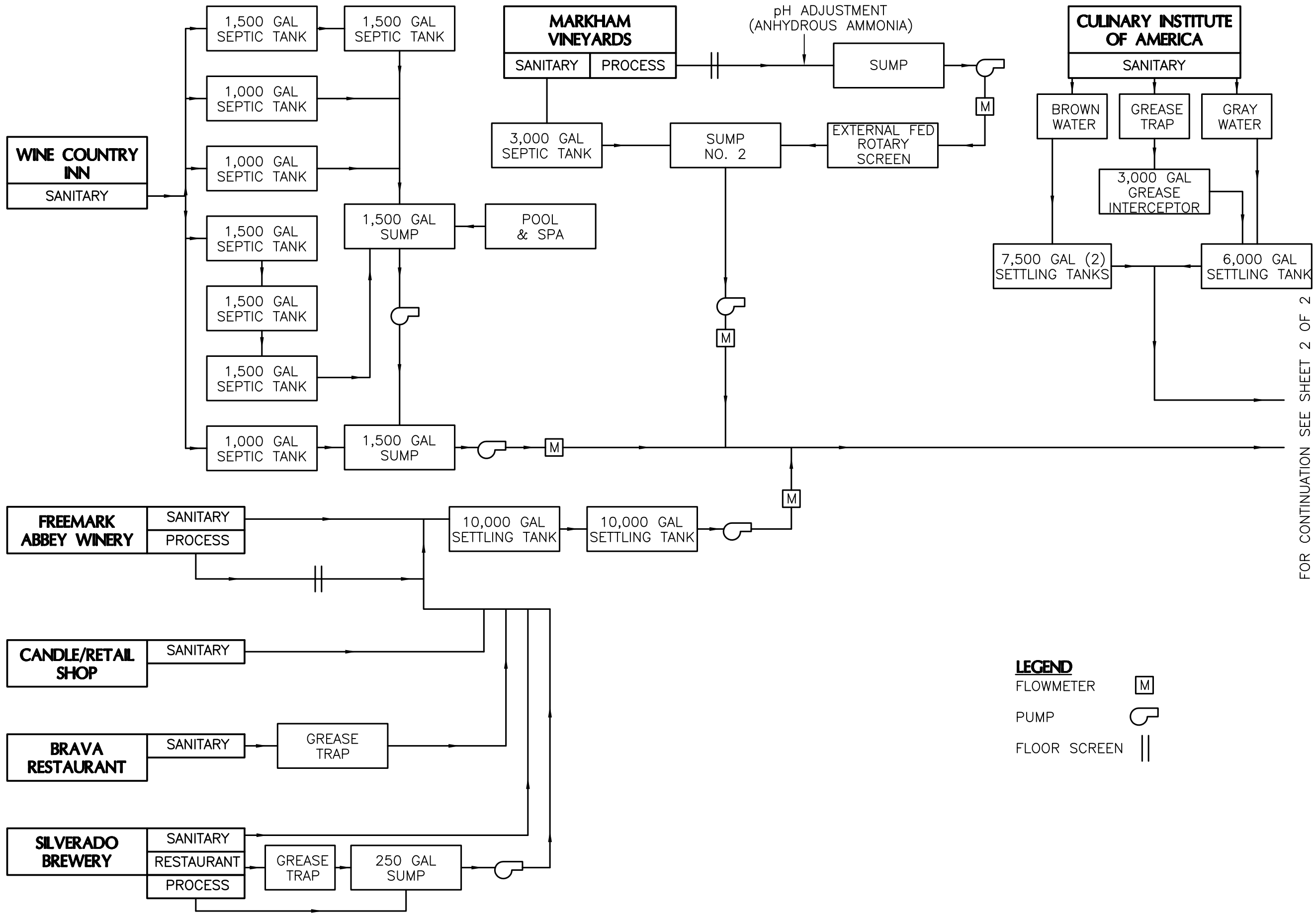

**LEGEND**

FLOWMETER



PUMP



FLOOR SCREEN



FOR CONTINUATION SEE SHEET 2 OF 2

**COMBINED WASTEWATER MANAGEMENT SYSTEM SCHEMATIC**

PROJECT NO. 2001075 DATE 2-12-02  
BY MW CHK AG SHT NO 1 OF 2

**MARKHAM VINEYARDS**  
2812 ST. HELENA HWY  
ST. HELENA, CALIFORNIA

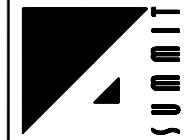

**SUMMIT ENGINEERING INC.**  
CONSULTING ENGINEERS  
1400 NORTH DUTTON AVE. #24  
SANTA ROSA, CALIF. 95401  
707.527.0775

FOR CONTINUATION SEE SHEET 1 OF 2

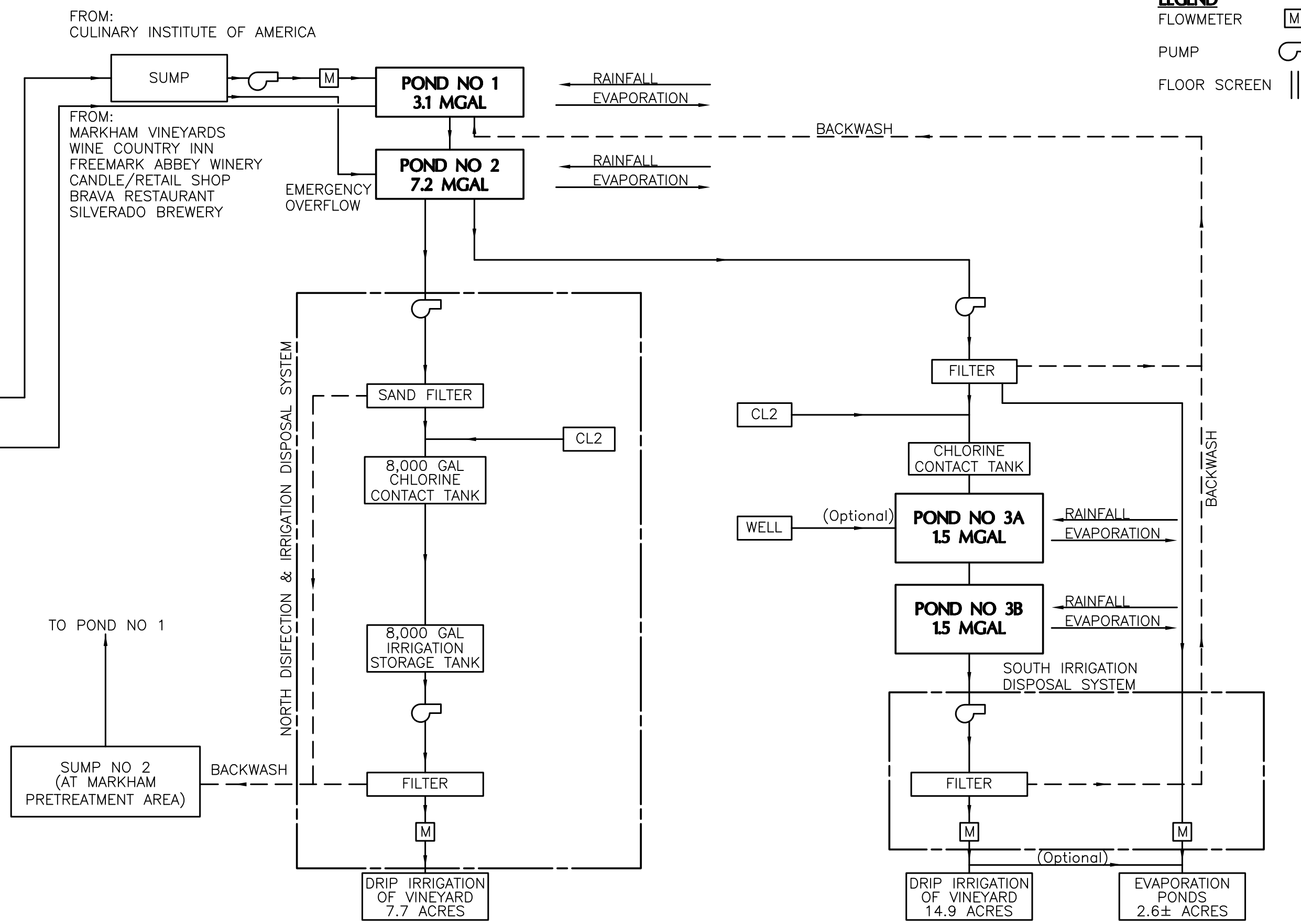

**SUMMIT ENGINEERING INC.**  
**CONSULTING ENGINEERS**  
 1400 NORTH DUTTON AVE. #24  
 SANTA ROSA, CALIF. 95401  
 707.527.0775

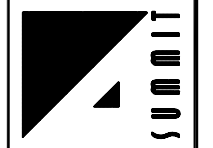

**COMBINED WASTEWATER MANAGEMENT SYSTEM SCHEMATIC**

PROJECT NO. 2001075 DATE 12-09-02  
 BY LW CHK AG SHT NO 2 OF 2

**MARKHAM VINEYARDS**  
 2812 ST. HELENA HWY  
 ST. HELENA, CALIFORNIA

MARKHAM VINEYARDS  
Project No. 2013171  
March 27, 2014

SUMMIT ENGINEERING, INC.  
Wastewater Feasibility Study  
BY: CN CHK: RR

---

ENCLOSURE B

COMBINED WASTEWATER MANAGEMENT SYSTEM OVERVIEW

## **INTRODUCTION**

### PROJECT DESCRIPTION

Markham Vineyards located at 2812 North St. Helena Highway in St. Helena, Napa County, is applying for a Use Permit (UP) Modification to allow for an increase in annual wine production to 429,000 gallons per year. The winery is currently permitted under Use Permit U-157879 for an annual wine production limit of 300,000 gallons per year. A modification to the approved marketing plan is not being proposed at this time.

Winery process wastewater (PW) is anticipated to increase at Markham Vineyards due to the proposed increase in annual wine production from 300,000 to 429,000 gallons wine per year. Sanitary sewage (SS) flows are not being modified at this time. PW and SS flows generated from Markham Vineyards are currently permitted for treatment through the existing combined wastewater management system (CWMS) located near the winery.

The existing CWMS treats wastewater generated from Markham Vineyards, Freemark Abby Winery (FMA), Culinary Institute of America (CIA), and Wine Country Inn (WCI), known collectively as the USERS. The permitted system includes flow allocations from the Brava Restaurant and Silverado Brewery (located in the Freemark Abby Winery complex) which is currently not in operation. The CWMS is permitted by the San Francisco Bay Region Regional Water Quality Control Board (RWQCB) and Napa County Planning, Building and Environmental Services (PBES) to treat 16.07 million gallons per year (Mgal/yr) of combined sanitary and process wastewater.

### BACKGROUND

The USERS currently operate the CWMS under a Joint Operating Agreement (JOA). Markham Vineyards currently operates, maintains and performs administration for the CWMS. The CWMS is regulated by Regional Water Quality Control Board (RWQCB) under Waste Discharge Requirements (WDR) Order No. 98-064 (adopted in 1999, revised in 2003). The 2003 ROWD prepared by Summit Engineering, currently serves as the governing WDR for the revised order. See Enclosure D for a copy of the 2003 ROWD.

### SITE DESCRIPTION

The existing winery is located near the intersection of North St. Helena Highway (Highway 29) and Deer Park Road, north of the town of St. Helena. The surrounding areas consist of neighboring vineyards, wineries, and restaurants. The parcel is relatively flat and borders the Napa River on the northern property side.

The existing CWMS, buildings, vineyards, roads, processing area, and property lines are located on the Overall Site Plan as shown in Enclosure A.



## EXISTING COMBINED WASTEWATER MANAGEMENT SYSTEM

The existing CWMS currently treats SS and PW flows from Markham Vineyards and Freemark Abbey. The CIA and WCI, contribute SS flows only. The permitted discharge capacity, per USER, in million gallons per year (Mgpy), is summarized below:

**TABLE 1 USER PERMITTED DISCHARGE CAPACITY**

USER	SS (Mgpy)	PW (Mgpy)	Total (Mgpy)
Wine Country Inn (WCI)	1.20	-	1.2
Freemark Abbey Complex <sup>1</sup>	2.18	1.82	4.0
Markham Vineyards	0.24	2.15	2.4
Culinary Institute – Greystone (CIA)	7.70	0.00	7.7
<i>5% contingency allocation</i>	<i>0.57</i>	<i>0.20</i>	<i>0.77</i>
<b>TOTAL</b>	<b>11.89</b>	<b>4.17</b>	<b>16.07</b>

Each USER facility includes various pretreatment systems to assist in reduction of solids and organic concentration of the wastewater delivered to the CWMS, as shown in the Combined Wastewater System Schematic, presented in Enclosure A. After pretreatment, the combined wastewater enters the existing wastewater treatment pond (Pond) No. 1 for aerobic biological treatment. Pond No. 1 has an existing treatment capacity of 3.1 Mgal and currently includes 35 horsepower (Hp) of brush aeration and 15 Hp of vertical turbine aeration. Effluent from Pond No. 1 flows into Pond No. 2 for additional treatment polishing and storage. Pond No. 2 has an existing capacity of 7.2 Mgal and currently includes 56 Hp of vertical turbine aeration.

After secondary treatment in Ponds No. 1 and 2, filtration and disinfection occurs prior to transfer to the storage Ponds No. 3A and 3B. Filtration is performed by an inline spin clean filter. Disinfection occurs using hypochlorite at the chlorine contact chambers located between Ponds No. 2 and 3A. The disinfected recycled water is stored in Ponds No. 3A and 3B and subsequently disposed via the south irrigation disposal system to the 14.9 acres of vineyard, located south of Ponds No. 3A and 3B. During warmer months (high evapotranspiration months) disinfected secondary-23 water is also disposed via the 2.6-acre evaporation ponds. A pressure sand filter and disinfection system (north disinfection and irrigation disposal system) allows for disposal of wastewater from Pond No. 2 to the 7.7-acre vineyards north of Pond No. 1. The total existing vineyard disposal area is 22.6 acres.

At peak discharge capacity, the following is a summary of the existing wastewater treatment pond layout, including existing aeration and hydraulic retention time (HRT), at the permitted discharge capacity:

<sup>1</sup> Wastewater flows from Freemark Abby include a 33% allocation from Inflow and Infiltration in the CWMS.

**TABLE 2 EXISTING POND INFORMATION**

<b>NAME</b>	<b>VOLUME (Mgal)</b>	<b>Total (Mgpy)</b>	<b>BRUSH AERATION (HP)</b>	<b>VT AERATION (HP)</b>	<b>HRT (days)</b>
Pond No. 1 (secondary treatment)	3.1	1.2	35	15	70
Pond No. 2 (polishing/storage)	7.2	4	-	46	164
Pond No. 3A (effluent storage)	1.5	2.4	-	-	-
Pond No. 3B (effluent storage)	1.5	7.7	-	-	-
<b>Total</b>	<b>13.33</b>	<b>16.07</b>	<b>35</b>	<b>61</b>	<b>235</b>

Current permitting allows for disposal of recycled water to the vineyards at rates of about 4 to 6 inches per month during the growing season and no more than 2.4 inches per month during the dormant season (November through March). See Enclosure A for the existing CWMS site plan and schematic and Enclosure D, for a copy of the 2003 ROWD.

### **MARKHAM PROPOSED WASTEWATER FLOWS**

Per the 2003 ROWD application, a higher wastewater flow assumption was used to allow for future expansion. The facility currently desires to modify their Use Permit and increase total wine production to 429,000 gallons of wine per year. The associated wastewater flow increase will be under the 16.07 Mgal/yr allowed by the 2003 ROWD.

Since Markham Vineyards is the only USER currently proposing a Use Permit modification, the remaining USER flows are not anticipated to change. A discussion of the current and proposed PW and SS flows for Markham Vineyards are discussed herein.

#### MARKHAM PW CHARACTERISTICS

Process wastewater will consist primarily of wastewater collected at floor drains and trenches within the winery, receiving, crush, tank, and washdown areas. Exterior tank and process areas not under a roof will be provided with diversion capability to provide a means of routing rainwater to the storm drainage system when those areas are not in use for process purposes. The following is a range of typical winery wastewater characteristics:

**TABLE 3 TYPICAL PW CHARACTERISTICS**

<u>Characteristic</u>	<u>Units</u>	<u>Crushing Season Range</u>	<u>Non-crushing Season Range</u>
pH	--	2.5 - 9.5	3.5 - 11.0
Dissolved Oxygen	mg/L	0.5 - 8.5	1.0 - 10.0
BOD <sub>5</sub>	mg/L	500 – 12,000	300 – 3,500
COD	mg/L	800 – 15,000	500 – 6,000
Grease	mg/L	5 - 30	5 - 50
Settleable Solids	mg/L	25 - 100	2 - 100
Nonfilterable Residue	mg/L	40 - 800	10 - 400
Volatile Suspended Solids	mg/L	150 - 700	80 - 350
Total Dissolved Solids	mg/L	80 – 2,900	80 – 2,900
Nitrogen	mg/L	1 - 40	1 - 40
Nitrate	mg/L	0.5 - 4.8	-
Phosphorous	mg/L	1 - 10	1 - 40
Sodium	mg/L	35 - 200	35 - 200
Alkalinity (CaCO <sub>3</sub> )	mg/L	40 - 730	10 - 730
Chloride	mg/L	3 - 250	3 - 250
Sulfate	mg/L	10 - 75	20 - 75

---

### MARKHAM PROCESS WASTEWATER FLOWS

Based on wastewater flow data collected from 1999-2003, a generation rate of 5 gallons per gallon of wine produced used was previously used to project annual PW flows in the 2003 ROWD. The facility recently incorporated water conservation techniques into winemaking practices. Additionally, refrigeration/cooling fixtures were retrofitted to make them more water efficient. Based on wastewater flow data over the past three years (2011 to present) the generation rate decreased to 4.5 gallons PW per gallon of wine. This generation rate is used in projecting the PW generated from the proposed increase in annual wine production to 429,000 gallons per year.

### WINE PRODUCTION

#### Annual Volume

Proposed annual production	=	429,000 gal wine/year
PW generation rate <sup>2</sup>	=	4.5 gal PW/gal wine
Projected Annual PW flow	=	429,000 gal wine x 4.5 gal PW/gal wine
	=	<u>1,930,500 gal PW/year</u>
<b>Projected Annual PW flow</b>	=	<b><u>1.93 Mgal PW/Year</u></b>
<b>Existing Permitted Annual PW flow</b>	=	<b><u>2.15 Mgal PW/Year</u></b>

#### Average Day Flow

$$1,930,500 \text{ gal PW}/365 \text{ days} = \underline{5,289 \text{ gal PW/day}}$$

#### Average Day Peak Harvest Month Flow<sup>3</sup>

$$1,930,500 \text{ gal PW} \times \frac{(0.11)}{31 \text{ day}} = \underline{6,850 \text{ gal PW/day}}$$

#### Napa County Peak Day

$$\frac{429,000 \text{ gallons wine} \times 1.5}{60 \text{ day harvest}} = \underline{10,725 \text{ gal PW/day}}$$

The projected annual PW flows (1.93 Mgal/year) does not exceed the permitted discharge capacity (2.15 Mgal/year).

---

<sup>2</sup> PW generation rate is based on wastewater flow data and tonnage crushed from 2011-2013.

<sup>3</sup> Based on historical flow data from 2011-2013, the harvest month of October accounts for approximately 11 percent of annual PW flow.

---

MARKHAM SANITARY SEWAGE CHARACTERISTICS

SS will consist primarily of wastewater generated from restrooms, laboratory, employee kitchen, and tasting room facilities. Typical sanitary sewage characteristics are as summarized below:

**TABLE 4 TYPICAL SS CHARACTERISTICS**

<u>Characteristic</u>	<u>Units</u>	<u>Raw Wastewater Range<sup>4</sup></u>
BOD <sub>5</sub>	mg/L	110 - 220
Grease	mg/L	50-100
Total Suspended Solids (TSS)	mg/L	100 - 220
Volatile Suspended Solids	mg/L	80 - 165
Total Dissolved Solids (TDS)	mg/L	250 - 500
Nitrogen	mg/L	20 - 40
Nitrate	mg/L	0
Phosphorous	mg/L	4 - 8
Alkalinity (CaCO <sub>3</sub> )	mg/L	50 - 100
Chloride	mg/L	30 - 50
Sulfate	mg/L	20 - 30

---

<sup>4</sup> Typical composition of untreated domestic wastewater, Metcalf & Eddy, "Wastewater Engineering, Third Edition", 1991

**MARKHAM SANITARY SEWAGE FLOWS**

SS flows are based on the approved marketing plan at Markham Vineyards. The annual, average, and peak day SS flows are calculated below:

Annual Volume

**Permitted Annual SS flow** = **0.24 Mgal SS/Year**

Average Day Flow

$$\frac{0.24 \text{ Mgal SS/year} \times 10^6 \text{ gal}}{1 \text{ Mgal} \times 365 \text{ days}} = \underline{657 \text{ gal SS/day}}$$

Napa County Peak Day

Based on current County flow generation rates and the approved marketing plan, the peak daily sanitary wastewater flow is calculated below:

Employee (full-time)	26	x 15 gpcd =	390	gpd
Employee (seasonal)	4	x 15 gpcd =	60	gpd
Tasting Visitors	50	x 3 gpcd =	150	gpd
Business Visitors	25	x 3 gpcd =	75	gpd
<b>Total Peak Day SS Flows</b>			<b>675</b>	<b>gpd</b>

Since Markham Vineyards is not proposed a modification to the approved marketing plan the permitted annual SS flow (0.24 Mgal SS/Year) is not anticipated to change.

**MARKHAM COMBINED FLOWS**

As summarized in the design criteria above, the following table summarizes the projected and permitted discharge flows for Markham Vineyards:

**TABLE 5 MARKHAM FLOW SUMMARY**

<b>MARKHAM VINEYARDS</b>	<b>SS (Mgpy)</b>	<b>PW (Mgpy)</b>	<b>Total (Mgpy)</b>
Projected	0.24	1.93	2.2
Permitted	0.24	2.15	2.4

## CONCLUSION

Per the 2003 ROWD, the existing CWMS treatment system was expanded/improved to allow for a combined wastewater discharge capacity of 16.07 Mgal/yr. Based on CMWS User flow data, the following chart displays the monthly average flows from 2011-2013:

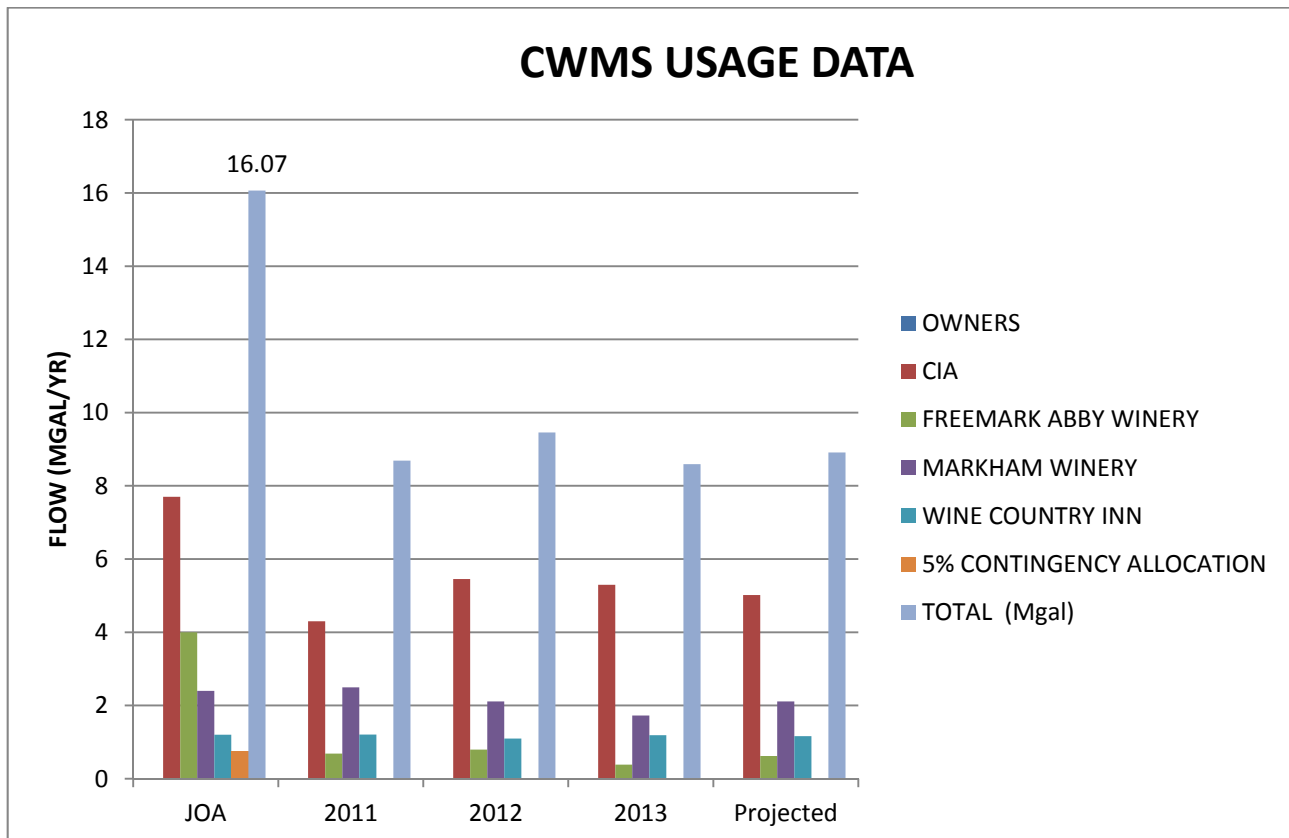

As shown above, the CWMS historical and projected flows are within the permitted discharge allowance of 16.07 Mgal/yr. Markham Vineyards should continue to incorporate water conservation techniques into winemaking and marketing operations in order to be consistent with the projected flows shown above.

Based on the permitted discharge capacity of each USER, the existing pond treatment system appears to have enough aeration to adequately treat influent biological loading at the permitted discharge capacity. Typical wastewater treatment ponds (with a facultative aerated environment) are designed with a HRT between 90-120 days to promote biological treatment. Based on the existing pond layout, the existing HRT for Pond No. 1 and 2 is 235 days (at permitted discharge capacity). This is well above the desired HRT range for optimum pond treatment. For additional information regarding the existing CWMS aeration/HRT calculations and original pond water balance, see Enclosure C.

Since the projected wastewater flows are within the permitted discharge capacity, and the CWMS appears capable of providing adequate treatment, a modification to the existing waste discharge requirements are not be proposed at this time.

## **OTHER CONSIDERATIONS**

### FOG Disposal

Due to the limited storage capacity, grease traps must be cleaned frequently. Cleaning can be performed by trained staff or a County permitted grease hauler per regulatory requirements.

### Odor Control

There should be no obnoxious odors from a properly designed and operated treatment system of these types. See Alternative Courses of Action for operation alternatives for unforeseen conditions.

### Ground Water Contamination

Where possible, the nearest water well to an area of the wastewater treatment and disposal systems should be a minimum of 100 feet

### Protection

Exposed wastewater treatment facilities should be posted with appropriate warning signs. The pretreatment area should be protected to restrict access and potential damage to the system.

### Alternate Course of Action

Although no operational difficulties are foreseen, the following additional courses of action would be available if necessary:

- 1) Ability to add carbon dioxide to reduce pH at the pretreatment site or installation of another type of pH control
- 2) Additional stages of treatment to increase effluent quality
- 3) Increased use of irrigation/disposal area to increase discharge capacity
- 4) Aeration in the effluent storage pond to improve effluent quality

The existing pond used for effluent storage prior to surface disposal has been designed for retention of wastewater through the majority of the rainy season with minimal discharges to the existing disposal field. Should there be a winter with more rainfall than the design condition; several operational procedures are available to compensate:

- 1) Additional water conservation at winery
- 2) Light irrigation during periods between storms -- not exceeding the assimilative capacity of the soil
- 3) Increased irrigation during the months of planned irrigation
- 4) Pumping and truck transfer of treated and diluted wastewater to an approved treatment plant or land disposal site



## SOLID WASTES

Solid wastes from the winery include primarily pomace, seeds, and stems. The estimated quantities of these wastes (at ultimate capacity) are as follows:

$$\text{Ultimate Annual Total} = \frac{1 \text{ ton grapes}}{165 \text{ gal wine}} \times 429,000 \text{ gal wine} \times 35\% = 910 \text{ tons}$$

Based on a unit weight of 38 pounds per cubic foot, the annual volume of solids wastes would be:

$$910 \text{ tons} \times \frac{2,000 \text{ lb}}{1 \text{ ton}} = 1,820,000 \text{ lbs}$$
$$1,820,000 \text{ lbs} \times \frac{1 \text{ ft}^3}{38 \text{ lb}} \times \frac{1 \text{ yd}^3}{27 \text{ ft}^3} = 1,774 \text{ yd}^3$$

All solid waste generated onsite will continue to be off hauled to Upper Valley Recycling, located in Napa County.

MARKHAM VINEYARDS  
Project No. 2013171  
March 27, 2014

SUMMIT ENGINEERING, INC.  
Wastewater Feasibility Study  
BY: CN CHK: RR

---

ENCLOSURE C

FLOW & POND AERATION/HRT CALCULATIONS

<b>SUMMIT ENGINEERING, INC.</b> Consulting Civil Engineers	<b>MARKHAM VINEYARDS</b> Wastewater Feasibility Study CWMS Design Criteria	<b>PROJECT NO.</b> <b>BY:</b> <b>CHK:</b>	<b>2013171</b> <b>CN</b> <b>RR</b>
---	--	---	--

**DESIGN CRITERIA**

**PROCESS WASTEWATER FLOWS**

Production Level	178,750 cases/year	
Annual Production	429,000 gal wine/year	
Crush Period	60 day	* per PBES criteria
Annual PW Flow	1,930,500 gal PW/year	
PW Generation Rate <sup>1</sup>	4.5 gal PW/gal wine	
Average Day Peak Monthly	6,862 gal PW/day	
Peak Harvest Day	10,725 gal PW/day	* per PBES criteria
Non-Peak Average Day	5,289 gal PW/day	

**SANITARY SEWAGE FLOWS**

Employee (full-time)	26 x 15 gpcd =	390 gpd	
Employee (seasonal)	4 x 15 gpcd =	60 gpd	
Tasting Visitors	50 x 3 gpcd =	150 gpd	
Buisness Visitors	25 x 3 gpcd =	75 gpd	
<b>Total Peak Day SS Flows</b>			<b>675 gpd</b>

\* per 2003 ROWD

**COMBINED FLOWS (PW & SS)**

Annual PW Flow	1,930,500 gal PW/yr	* Projected
Annual SS Flow	240,000 gal SS/yr	* Permitted
<b>Total CW Flow</b>	<b>2,170,500 gal CW/yr</b>	
	2.17 Mgal/yr	

**MARKHAM DESIGN PW/SS FLOWS**

Month	(E) Monthly Percentage of Annual Flow <sup>1</sup> %	(E) Monthly Makham WW Flow (Mgal)
August	7.0%	0.14
September	8.7%	0.17
October	11.0%	0.21
November	10.3%	0.20
December	8.6%	0.17
January	7.9%	0.15
February	8.9%	0.17
March	9.9%	0.19
April	7.2%	0.14
May	7.0%	0.14
June	7.1%	0.14
July	6.2%	0.12
<b>Total</b>	<b>100%</b>	<b>1.93</b>

NOTES:

1. Monthly percentages based on wastewater data collected from 2011-2013

<b>SUMMIT ENGINEERING, INC.</b> Consulting Civil Engineers	<b>MARKHAM VINEYARDS</b> Wastewater Feasibility Study Pond Aeration/HRT Calculations	PROJECT NO. 2013171 BY: CN CHK: RR
---	--	--

**PERMITTED DISCHARGE CAPACITY**

USER	SS (Mgpy)	PW (Mgpy)	Total (Mgpy)
Wine Country Inn (WCI)	1.20	-	1.20
Freemark Abbey Complex <sup>1</sup>	2.18	1.82	4.00
Markham Winery	0.24	2.15	2.40
Culinary Institute – Greystone (CIA)	7.70	0.00	7.70
<i>5% contingency allocation</i>	<i>0.57</i>	<i>0.20</i>	<i>0.77</i>
<b>TOTAL</b>	<b>11.89</b>	<b>4.17</b>	<b>16.07</b>

**EXISTING POND TREATMENT SYSTEM**

NAME	VOLUME <sup>2</sup> (Mgal)	BRUSH AERATION (HP)	VT AERATION (HP)	HRT (days)
Pond No. 1 (secondary treatment)	3.1	35	15	70
Pond No. 2 (polishing/storage)	7.2	-	46	164
Pond No. 3A (effluent storage)	1.5	-	-	-
Pond No. 3B (effluent storage)	1.5	-	-	-
Total	13.33	35	61	235

**AERATION SIZING PARAMATERS**

PW BOD Concentration	7,700 mg/L
PW Peak Day <sup>3</sup>	16,589 gal PW/day
SS BOD Concentration	350 mg/L
SS Avg Daily Flow	32,564 gal SS/day
Combined BOD Concentration	2,831 mg/L
Combined Daily Flow (PW/SS)	49,154 gal/day
Oxygen Requirement	1.5 lbs O <sub>2</sub> /lb BOD
Oxygen Transfer Rate (Brush)	2.2 lbs O <sub>2</sub> /HP - hr
Oxygen Transfer Rate (VT)	1.8 lbs O <sub>2</sub> /HP - hr
Power/ Volume Ratio, Pond No. 1	0.10 - 0.20 Hp/1,000 cu ft
Power/ Volume Ratio, Pond No. 2	0.05 - 0.10 Hp/1,000 cu ft
Pond No. 1 Volume	3.10 Mgal
Pond No. 2 Volume	7.23 Mgal

**NOTES:**

- Includes inflow & infiltration at 33%.
- Pond Volume excludes 2' of freeboard volume.
- Sizing for PW peak day based on Napa County minimum requirements for Markham Winery (429,000 gallons wine/year), Freemark Abby (207,900 gallons wine/year), and Silverado Brewery (20,000 gallons beer/year).

**EXISTING POND NO. 1 AERATION**

---

BOD Mass Loading	1,161 lbs BOD/day
Aerator Run Time	24 Hrs/day
Oxygen Requirement	73 lbs O <sub>2</sub>
Aerator Horsepower Required	36 HP
Existing Brush Aerator HP	35 HP
Existing VT Aerator HP	15 HP
Existing Total Aeration (Brush + VT)	50 HP
Aerator Hp Recommended	0 HP
Existing Oxygen Transfer Rate (Brush + VT)	78 lbs O <sub>2</sub>

Check Power-to-Volume Ratio 0.12 Hp/ 1,000 CF

P\V range desired is 0.10 to 0.30, this will enable oxygen transfer and mixing to occur within the upper 3-4 feet of the pond as required in a facultative aerated lagoon system.

**EXISTING POND NO. 2 AERATION**

---

Existing Total Aeration (VT)	46 HP
Aerator Hp Recommended	0 Hp
Check Power-to-Volume Ratio	0.05 Hp/ 1,000 CF

P\V acceptable range is 0.05 - 0.10.

MARKHAM VINEYARDS  
Project No. 2013171  
March 27, 2014

SUMMIT ENGINEERING, INC.  
Wastewater Feasibility Study  
BY: CN CHK: RR

---

ENCLOSURE D

2003 RWQCB ROWD LETTER OF COMPLETENESS  
2003 ROWD (REVISED WDR)  
RWQCB WDR, ORDER NO. 98-064



Winston H. Hickox  
 Environmental Protection

San Francisco Bay Region



Gray Davis  
 Governor

1515 Clay Street, Suite 1400, Oakland, California 94612  
 Phone (510) 622-2300 || Fax (510) 622-2460  
 Internet Address: <http://www.swrcb.ca.gov>

Date: August 19, 2003  
 File No.: 2139.3114 (BDA)

RECEIVED  
 AUG 21 2003

NAPA CO. CONSERVATION  
 DEVELOPMENT & PLANNING DEPT.

Mr. David W. Flanary  
 Wastewater System Manager  
 Markham Vineyards  
 P. O. Box 636  
 St. Helena, CA 94574

**SUBJECT: Combined Wastewater Management System for Markham Vineyards, et al, St. Helena, Napa County - Complete Report of Waste Discharge for Proposed Wastewater System Improvements**

Dear Mr. Flanary:

The purpose of this letter is to respond to the report of waste discharge (ROWD) submitted to this office earlier this year in application for revised Waste Discharge Requirements (WDRs) for the subject wastewater system. Information submitted as part of the ROWD is described below. Based on our review of the information submitted, we find the ROWD to be complete and the proposed improvements to be acceptable. Revised WDRs will be based on the ROWD, as well as other relevant information. We have no objections to Napa County proceeding with issuance of applicable permits for implementation of the improvements.

In brief, the proposed improvements include repair of existing pond perimeter and internal dikes, addition of mechanical aeration equipment to the facultative aeration ponds, increased disinfection system contact time to meet state standards, and repairs and improvements to the irrigation disposal system pumping and distribution equipment. With the improvements, the wastewater system will have a treatment and disposal capacity of 16.07 million gallons per year.

Report of Waste Discharge

The ROWD was submitted by letter dated January 7, 2003 from Summit Engineering, Inc (SEI), the Dischargers' engineering consultant, and was received at our office on January 8, 2003. The ROWD includes a completed application form (Form 200), and related technical information. Additional information was submitted by transmittal memo from SEI dated July 22, 2003, received July 23, 2003. Information submitted is identified below.

- (1) The January 7, 2003 submittal includes the following:
  - (a) Cover Letter, January 7, 2003, SEI to RWQCB, 2 pages (Re: "Markham Combined Wastewater Management System ...").
  - (b) ROWD Application Form (Form 200), for *Markham Winery Combined Wastewater Management System*, signed 12/9/02, by David Flanary, Chief Financial Officer, Markham Winery; 3 pages.

August 19, 2003

County Use Permit

The July 22, 2003 submittal identifies that the discharger is pursuing modification of the County Use Permit for the wastewater system to address the proposed improvements, and that an application for Use Permit modification has been submitted to Napa County. It is our understanding that proposed improvements will be in accordance with the information submitted to this office as part of the ROWD. We have no objections to Napa County proceeding with issuance of applicable permits for these projects, or to construction of the proposed modifications of the wastewater system as described in the ROWD. Requirements identified in permits issued by Napa County for the project which pertain to the wastewater system will be incorporated as necessary in the WDRs. Please submit copies of permits issued by Napa County for the project, and relevant correspondence, upon completion of such documents.

System Maintenance Improvements

The July 22, 2003 submittal also identifies that the discharger is pursuing implementation, this summer, of selected improvements related to system maintenance. Napa County Department of Environmental Management has approved plans for wastewater system modifications, by letter dated July 16, 2003 to SEI. That letter includes the following condition of approval: "2. All necessary clearances and/or approvals from the Bay Area Regional Water Quality Control Board shall be obtained prior to commencing work" The proposed work consists of wastewater system improvements necessary to maintain an adequate and reliable wastewater system. Such improvements are consistent with the WDRs and do not involve changes in the volume or location of the discharges. The discharger has notified the Regional Board of the proposed improvements by submittal of the aforementioned ROWD. We have reviewed the ROWD and found it be complete and the improvements acceptable. No further clearances or approvals by this office are necessary for implementation of the improvements addressed by the County's July 16, 2003 letter. Please submit copies of permits issued by Napa County for the project, and relevant correspondence, upon completion of such documents.

If you have any questions about these matters, please contact me at:  
Phone: (510) 622 - 2305; Fax: (510) 622 - 2460; or e-mail: bda@rb2.swrcb.ca.gov.

Sincerely,

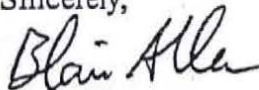

Blair Allen,  
Water Resources Control Engineer  
North Bay Watershed Management Division

cc: Ms. Nancy Johnson, Napa County Conservation, Development and Planning Department  
1195 Third Street, Room 210, Napa, CA 94559  
Mr. Sheldon Sapoznik, REHS, Napa County Department of Environmental Management  
1195 Third Street, Room 101, Napa, CA 94559  
Mr. Bill Phillips, P.E., Founding Principal, Summit Engineering, Inc.  
1400 N. Dutton Ave., # 24, Santa Rosa, CA 95401





January 7, 2003

Mr. Blair Allen  
Water Resources Control Engineer  
Regional Water Quality Control Board  
San Francisco Bay Region  
1515 Clay Street, Suite 1400  
Oakland, CA 94612

Re: Markham Combined Wastewater Management System  
2812 St. Helena Hwy., St. Helena, Napa County, CA 94550  
Project Number 2002086

Dear Mr. Allen:

This correspondence is provided to present the evaluation and proposed improvements to the Markham Combined Wastewater Management System (CWMS) in St. Helena. As you are aware, the existing facility operates under WDR No. 98-064 and serves Markham Winery, Wine County Inn, Freemark Abbey and the Culinary Institute of America. The improvements proposed herein will increase the capacity of the facility to 16.07 million gallons per year. Summit Engineering, Inc. has been retained by Markham Winery, the operating user, to evaluate the wastewater management system.

The project site currently consists of operating aerated ponds, disinfection and vineyard irrigation facilities. Wastewater is treated in two facultative aerated ponds with a combined volume of 10.4 million gallons. The treated wastewater is then filtered and disinfected prior to drip irrigation of 22.6 acres of vineyard. An additional 3 million gallons of storage is available as well as two evaporation ponds that are utilized during the summer. The proposed improvements will increase the aeration capacity and upgrade the disinfection and irrigation pumping facilities sufficient to support the revised treatment capacity of 16.07 million gallons per year.

With the proposed wastewater management facilities described above and herein, the new systems will be adequate to treat and dispose of the projected wastewater flows. To assist you in the evaluation of the above conclusions, the following information is enclosed:

- Application Form (No. 200)
- November 2002 Markham CWMS Evaluation

A copy of the CWMS Evaluation has also been forwarded to Bob Nelson at Napa County Conservation, Development and Planning Department for his determination as to how to proceed with revisions to Use Permit 93006-UP and any associated environmental review.

Mr. Blair Allen  
Project No. 2002086  
January 7, 2003  
Page 2

We trust that this information will be sufficient for your review. Please advise us of the amount of the application fee and we will coordinate payment with Markham Winery. Should any further information be required, please feel free to contact me at (707) 527-0775.

Sincerely,

A handwritten signature in black ink, appearing to read "Glenn Dombeck", written in a cursive style.

Glenn Dombeck, P.E.  
ASSOCIATE

cc: David Flanary, Markham Winery



**APPLICATION/REPORT OF WASTE DISCHARGE  
GENERAL INFORMATION FORM FOR  
WASTE DISCHARGE REQUIREMENTS OR NPDES PERMIT**



**I. FACILITY INFORMATION**

**A. Facility:**

Name: Markham Winery Combined Wastewater Management System			
Address: 2812 St. Helena Highway North			
City: St. Helena	County: Napa	State: CA	Zip Code: 94574
Contact Person: David Flanary		Telephone Number: (707) 963-5292	

**B. Facility Owner:**

Name: Markham Winery			Owner Type (Check One)	
Address: 2812 St. Helena Highway North			1. <input type="checkbox"/> Individual    2. <input checked="" type="checkbox"/> Corporation	
City: St. Helena	State: CA	Zip Code: 94574	3. <input type="checkbox"/> Governmental Agency    4. <input type="checkbox"/> Partnership Agency	
Contact Person: David Flanary			Telephone Number: (707) 963-5292	Federal Tax ID: 82-0255511
			5. <input type="checkbox"/> Other: _____	

**C. Facility Operator (The agency or business, not the person):**

Name: Markham Winery			Operator Type (Check One)	
Address: 2812 St. Helena Highway North			1. <input type="checkbox"/> Individual    2. <input checked="" type="checkbox"/> Corporation	
City: St. Helena	State: CA	Zip Code: 94574	3. <input type="checkbox"/> Governmental Agency    4. <input type="checkbox"/> Partnership Agency	
Contact Person: David Flanary			Telephone Number: (707) 963-5292	
			5. <input type="checkbox"/> Other: _____	

**D. Owner of the Land:**

Name: Markham Winery			Owner Type (Check One)	
Address: 2812 St. Helena Highway North			1. <input type="checkbox"/> Individual    2. <input checked="" type="checkbox"/> Corporation	
City: St. Helena	State: CA	Zip Code: 94574	3. <input type="checkbox"/> Governmental Agency    4. <input type="checkbox"/> Partnership Agency	
Contact Person: David Flanary			Telephone Number: (707) 963-5292	
			5. <input type="checkbox"/> Other: _____	

**E. Address Where Legal Notice May Be Served:**

Address: 2812 St. Helena Highway North			
City: St. Helena	State: CA	Zip Code: 94574	
Contact Person: David Flanary			Telephone Number: (707) 963-5292

**F. Billing Address:**

Address: P.O. Box 636			
City: St. Helena	State: CA	Zip Code: 94574	
Contact Person: David Flanary			Telephone Number: (707) 963-5292



APPLICATION/REPORT OF WASTE DISCHARGE GENERAL INFORMATION FORM FOR WASTE DISCHARGE REQUIREMENTS OR NPDES PERMIT



II. TYPE OF DISCHARGE

Check Type of Discharge(s) Described in this Application (A or B):

A. WASTE DISCHARGE TO LAND

B. WASTE DISCHARGE TO SURFACE WATER

Check all that apply:

- Domestic/Municipal Wastewater Treatment and Disposal
- Cooling Water
- Mining
- Waste Pile
- Wastewater Reclamation
- Other, please describe: \_\_\_\_\_

- Animal Waste Solids
- Land Treatment Unit
- Dredge Material Disposal
- Surface Impoundment
- Industrial Process Wastewater

- Animal or Aquacultural Wastewater
- Biosolids/Residual
- Hazardous Waste (see instructions)
- Landfill (see instructions)
- Storm Water

III. LOCATION OF THE FACILITY

Describe the physical location of the facility.

1. Assessor's Parcel Number(s)  
 Facility: 22-200-13 & 22-200-15  
 Discharge Point: 22-200-15  
 22-200-20  
 22-200-25  
 22-200-03

2. Latitude  
 Facility: 38° 31' 15"  
 Discharge Point: 38° 31' 15"

3. Longitude  
 Facility: 122° 29' 12"  
 Discharge Point: 122° 29' 12"

IV. REASON FOR FILING

- New Discharge or Facility
- Change in Design or Operation
- Change in Quantity/Type of Discharge
- Changes in Ownership/Operator (see instructions)
- Waste Discharge Requirements Update or NPDES Permit Reissuance
- Other: \_\_\_\_\_

V. CALIFORNIA ENVIRONMENTAL QUALITY ACT (CEQA)

Name of Lead Agency: Napa County Planning Department

Has a public agency determined that the proposed project is exempt from CEQA?  Yes  No

If Yes, state the basis for the exemption and the name of the agency supplying the exemption on the line below.

Basis for Exemption/Agency: \_\_\_\_\_

Has a "Notice of Determination" been filed under CEQA?  Yes  No

If Yes, enclose a copy of the CEQA document, Environmental Impact Report, or Negative Declaration. If no, identify the expected type of CEQA document and expected date of completion.

Expected CEQA Documents:

- EIR
- Negative Declaration

Expected CEQA Completion Date: February 2003

CALIFORNIA ENVIRONMENTAL PROTECTION AGENCY



State of California Regional Water Quality Control Board

APPLICATION/REPORT OF WASTE DISCHARGE GENERAL INFORMATION FORM FOR WASTE DISCHARGE REQUIREMENTS OR NPDES PERMIT



VI. OTHER REQUIRED INFORMATION

Please provide a COMPLETE characterization of your discharge. A complete characterization includes, but is not limited to, a list of constituents and the discharge concentration of each constituent, a list of other appropriate waste discharge characteristics, a description and schematic drawing of all treatment processes, a description of any Best Management Practices (BMPs) used, and a description of disposal methods.

Also include a site map showing the location of the facility and, if you are submitting this application for an NPDES permit, identify the surface water to which you propose to discharge. Please try to limit your maps to a scale of 1:24,000 (7.5' USGS Quadrangle) or a street map, if more appropriate.

VII. OTHER

Attach additional sheets to explain any responses which need clarification. List attachments with titles and dates below:

See November 2002 Markham Combined Wastewater Management System Evaluation

You will be notified by a representative of the RWQCB within 30 days of receipt of your application. The notice will state if your application is complete or if there is additional information you must submit to complete your Application/Report of Waste Discharge, pursuant to Division 7, Section 13260 of the California Water Code.

VIII. CERTIFICATION

"I certify under penalty of law that this document, including all attachments and supplemental information, were prepared under my direction and supervision in accordance with a system designed to assure that qualified personnel properly gathered and evaluated the information submitted. Based on my inquiry of the person or persons who manage the system, or those persons directly responsible for gathering the information, the information submitted is, to the best of my knowledge and belief, true, accurate, and complete. I am aware that there are significant penalties for submitting false information, including the possibility of fine and imprisonment."

Print Name: DAVID W. FLANAGAN

Title: CHIEF FINANCIAL OFFICER

Signature:

[Handwritten signature of David W. Flanagan]

Date:

12/9/02

**MARKHAM  
COMBINED WASTEWATER  
MANAGEMENT SYSTEM EVALUATION  
NAPA COUNTY, CALIFORNIA**

November 2002

**Project No. 2002086**

Prepared by:



**SUMMIT ENGINEERING, INC.**  
Consulting Civil Engineers  
1400 North Dutton Avenue, Suite 24  
Santa Rosa, CA 95401-7152  
(707) 527-0775

**TABLE OF CONTENTS**

EXECUTIVE SUMMARY .....2  
INTRODUCTION .....3  
    OBJECTIVE.....3  
    AUTHORIZATION.....3  
    BACKGROUND .....3  
EXISTING WASTEWATER MANAGEMENT SYSTEM.....4  
    DESCRIPTION OF EXISTING CWMS .....4  
    WASTE DISCHARGE REQUIREMENTS.....4  
    JOINT OPERATING AGREEMENT.....5  
DESCRIPTION OF USERS.....6  
    FIGURE 1 HISTORICAL WASTEWATER FLOWS .....6  
    TABLE 1 WASTEWATER FLOWS BY USER.....7  
CAPACITY EVALUATION .....8  
    POND WATER BALANCE .....8  
    RECOMMENDED CAPITAL IMPROVEMENTS .....8

ENCLOSURES:

- A VICINITY MAP  
    SITE LAYOUT  
    COMBINED WASTEWATER MANAGEMENT SYSTEM SCHEMATIC
- B COMBINED WASTEWATER MANAGEMENT SYSTEM PROJECTED WASTEWATER FLOW  
    CALCULATIONS
- C COMBINED WASTEWATER MANAGEMENT SYSTEM POND WATER BALANCE

## **EXECUTIVE SUMMARY**

The combined wastewater management system (CWMS) treats wastewater from Markham Winery, Freemark Abbey Winery (including Brava Restaurant and Silverado Brewery) (FMA), Culinary Institute of America (CIA), and Wine Country Inn (WCI), known collectively as the USERS. The current CWMS is permitted by the San Francisco Bay Region Regional Water Quality Control Board and Napa County Environmental Management to treat 9.985 million gallons per year (Mgal/yr) of combined sanitary and process wastewater. The wastewater flows recorded from November 2000 to November 2001 exceeded the permitted allotment at 12.46 Mgal. The wastewater flows again exceeded the permitted allotment in 2002 at 14.07 Mgal. Due to the increased flows and potential expansion plans of several of the USERS an evaluation of the CWMS capacity was authorized and performed.

Based upon the information provided by the USERS the *projected* wastewater flow is determined to be 16.07 Mgal/yr. This includes a 5 percent contingency added to the *projected* flows to account for unanticipated increases (such as flow metering errors). The performance of the CWMS was evaluated at the *projected* flows. An evaluation was performed to ensure adequate detention time, biochemical oxygen demand reduction and disposal area. In order to be conservative and since there is no benefit from the evaporation ponds in the winter months the evaluation of disposal did not include the evaporation ponds. However, it is recognized that the evaporation ponds will augment the disposal capability of the system in the summer months. In addition, improvement items were noted to ensure proper operation of the CWMS at the current and *projected* flows.

It has been determined that the CWMS can adequately treat and dispose of the *projected* wastewater flows (16.07 Mgal/yr). However, improvement items will be needed to reach this capacity. The improvements include, but are not limited to; increased aeration, increased chlorine contact time at the transfer station between Ponds No. 2 and 3A and re-furbishing of the north disinfection and irrigation disposal system.



## **INTRODUCTION**

### **OBJECTIVE**

The purpose of this report is to evaluate the combined wastewater management system (CWMS) at Markham Winery on Highway 29, north of St. Helena, in Napa County, California, for the ability to increase the system capacity, in consideration of *projected* future requirements for the USERS of the system.

### **AUTHORIZATION**

Markham Winery granted authorization to Summit Engineering on December 20, 2001 to evaluate the capacity of the CWMS at the *projected* wastewater flows.

### **BACKGROUND**

The CWMS currently treats sanitary and process wastewater (SW and PW, respectively) from the following entities: Markham Winery, Freemark Abbey Winery (FMA), Culinary Institute of America (CIA), and Wine Country Inn (WCI), known collectively as USERS. FMA also includes flows from Brava Restaurant, Silverado Brewery and miscellaneous offices and retail. See Enclosure A, for a Vicinity Map.

Prior to construction of the 1990 CWMS improvements, the ponds were operated as terminal evaporation ponds for combined PW and SW from Markham Winery, Freemark Abbey Winery and Wine Country Inn. A study conducted by Summit Engineering, Inc. in 1989 at the request of Markham Winery management concluded that the ponds could not adequately dispose of effluent by evaporation alone. At this point it was determined that the ponds were large enough to provide adequate treatment as aerated lagoons with disposal by vineyard irrigation.

In 1993, the CIA was connected to the CWMS and the system capacity was evaluated and subsequently permitted for wastewater flows *projected* in 1993 at 9.985 Mgal/yr. The CWMS was evaluated for this total annual flow based upon the historic and *projected* wastewater flows available at that time. The CWMS was improved at that time to accommodate the addition of the CIA wastewater flows, including the addition of the existing CIA storage Ponds No. 3A and 3B and 14.9 acres of additional vineyards for disposal.

The USERS currently operate the CWMS under a Joint Operating Agreement (JOA) dated May 27, 1994. Markham Winery currently operates, maintains and performs administration for the CWMS. The CWMS is regulated by the Regional Water Quality Control Board (RWQCB) as outlined in Waste Discharge Requirements (WDR) Order No. 98-064. The CWMS was granted Use Permit No. 93006-UP in 1993.

## **EXISTING WASTEWATER MANAGEMENT SYSTEM**

### DESCRIPTION OF EXISTING CWMS

Markham Vineyards, Freemark Abbey, and CIA contribute both sanitary wastewater (SW) and process wastewater (PW) to the CWMS. WCI contributes only SW to the CWMS. Each USER facility includes various pretreatment equipment items to assist in reduction of solids and organic concentration of the wastewater delivered to the CWMS, as shown in the Combined Wastewater System Schematic, presented in Enclosure A. After pretreatment, the combined wastewater enters Pond No. 1 for aerobic biological treatment. Pond No. 1 has a capacity of 3.11 million gallons (Mgal) and has one 15 horsepower (Hp) and two 10 Hp aerators installed. Pond No. 2 has a capacity of 7.23 Mgal and has two 3 Hp aerators installed. Pond No. 2 primarily provides additional settling and storage of treated effluent.

After the secondary treatment in Ponds No. 1 and 2, filtration and disinfection occurs prior to transfer to the storage Ponds No. 3A and 3B. Filtration is performed by an inline spin clean filter. Disinfection occurs using hypochlorite at the chlorine contact chambers located between Ponds No. 2 and 3A. The disinfected recycled water (per Title 22, Division 4) is stored in Ponds No. 3A and 3B and subsequently disposed via the south irrigation disposal system to the 14.9 acres of vineyard south of Ponds No. 3A and 3B. During warmer months (high evapotranspiration months) disinfected secondary-23 water is also disposed via the 2.6-acre evaporation ponds. The CWMS was constructed in 1990 to utilize a total of 22.6 acres of vineyard for disposal of which only 14.9 acres is currently being utilized. In 1990, a pressure sand filtration and disinfection system (north disinfection and irrigation disposal system) was constructed allowing the disposal of wastewater from Pond No. 2 to the 7.7-acre vineyards north of Pond No. 1, see the Site Layout presented in Enclosure A. However, the north disinfection and irrigation disposal system is currently in need of repairs and is not being used.

### WASTE DISCHARGE REQUIREMENTS

The current RWQCB WDRs, Order No. 98-064, allow disposal of disinfected secondary-23 and filtered recycled water to the vineyards at rates of about 4 to 6 inches per month during the growing season and no more than 2.4 inches per month during the dormant season (November through March). In addition, the WDR self-monitoring reports include the results from water quality samples collected from the treated wastewater irrigation water. The analysis and quality limits are:

To be collected monthly at locations in the ponds and pond effluent:

- |  |            |
|--|------------|
| • Five day biochemical oxygen demand (BOD <sub>5</sub> ) | 40.0 mg/L  |
| • Dissolved oxygen                                       | 1.0 mg/L   |
| • Dissolved sulfides (when D.O. below 2 mg/L)            | 0.1 mg/L   |
| • pH   | 6.0 to 9.0 |

Additionally, total coliform is to be taken three times per week on non-consecutive days and to satisfy the following quality limits:

- Total coliform organisms shall not exceed 23 MPN/100 mL as determined from the results of the last seven days for which analyses have been completed
- The number of total coliform organisms shall not exceed 240 MPN/100 mL in any two consecutive samples.

The WDR self-monitoring reports (to be submitted quarterly) also include the total flow entering the CWMS and the quantity disposed to the vineyards.

Correspondence with the RWQCB and Napa County Environmental Management verified that no new requirements would likely be imposed upon the system. The WDRs are scheduled for review in 2008, however it will be necessary to submit a Report of Waste Discharge for the proposed capacity improvements. Similarly it will be necessary to submit a Use Permit Modification to Napa County Planning to revise the current Use Permit for the proposed capacity improvements.

#### JOINT OPERATING AGREEMENT

The USERS operate the CWMS under the JOA dated May 27, 1994. The operating costs are distributed between the USERS based upon the annual wastewater flow percentage, as presented in Table 1 on Page 7.

## **DESCRIPTION OF USERS**

Several USERS either are planning expansions, renovations or are currently expanding/renovating. The *projected* increase of wastewater flows due to the expansion is 16.07 Mgal/yr. A more detailed accounting of the *projected* individual flow increases is presented in Enclosure B, Projected Wastewater Flow Calculations. The potential expansions are explained below and current and *projected* flows are described below.

Markham Winery may expand its future operation up to 2,600 tons of annual production. The wastewater flows are anticipated to increase due to this expansion as additional disposal area (vineyards) may become available.

FMA is currently renovating the candle retail shop into a wine tasting shop. There is no *projected* increase in sanitary wastewater flows due to this renovation. FMA may increase the future wine production up to 1,260 tons of annual production. Silverado Brewery is anticipating an increase in production to an ultimate capacity between 15,000 to 20,000 gallons per year. Brava Restaurant is currently under litigation. When the restaurant re-opens, it is assumed the wastewater flows will not be increased over the historical wastewater flows.

The CIA is in the planning stages of expansion to their facility. The expansion will include the an additional 60 dormitory beds, upgrading of the Still House to a center for professional wine studies and the expansion of the existing restaurant and cooking facilities.

WCI has renovated to include 5 additional cottages and removal of a 3-bedroom house. In this renovation, WCI installed two new 1,500-gallon pump sumps with two  $\frac{3}{4}$  horsepower Goulds sump pumps, removed five existing septic tanks and subsequent piping and installed five 1,500-gallon septic tanks, three 1,000-gallon septic tanks and subsequent piping. The new septic tanks are fitted with Zabel effluent filters. WCI replaced the existing surface drainage system and disconnected the drainage flows from the wastewater system. In addition, WCI disconnected the pool overflow from the wastewater system. There is no increase in wastewater flows due to this renovation and the wastewater flows should be reduced since the stormwater is being diverted away from the wastewater system. However, an increase in wastewater flows has been *projected* based upon potential increased occupancy, potential future development of a spa and past meter inaccuracies at WCI.

During the period from November 2000 to November 2002, the USERS contributed wastewater flows (12.46 Mgal in 2001 and 14.07 Mgal in 2002) exceeding the annual allotment (9.985 Mgal). Markham Winery was the only USER below their allotment during both years, as can be seen in Figure 1, Historical Wastewater Flows, presented on the next page. Table 1, Flow by USER, summarizes the current flows, JOA flow capacities, and *projected* flows by USER. Review of the operations at the WCI and FMA suggest that the flowmeters for these entities have been inaccurate. These flowmeters have since undergone repair. The flowmeter at WCI was tested by an independent third party, and was determined to be out of calibration and was over reporting the flows by 12 to 25 percent. The flowmeters at CIA and Markham have not been tested to date. However, Markham Winery as operating USER will be conducting standardized calibration testing of the flowmeters at each of the USERS facilities and will repair or replace inaccurate meters as part of this calibration program.

FIGURE 1 HISTORICAL WASTEWATER FLOWS

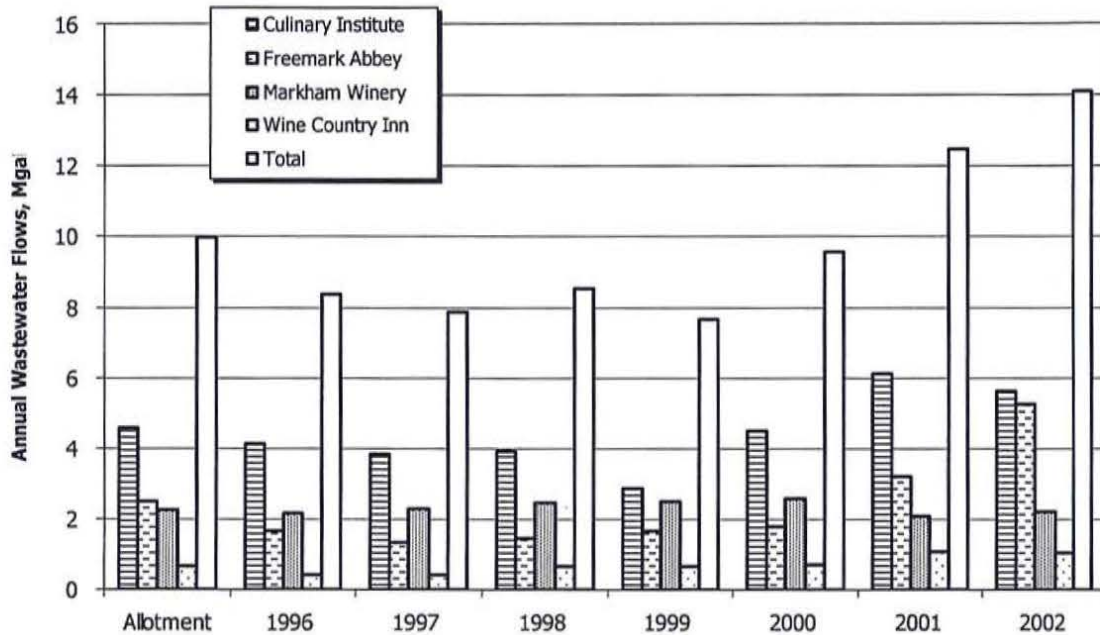

TABLE 1 WASTEWATER FLOWS BY USER

USER	JOA Mgal/yr	Nov. '00 to Nov. '01 Mgal/yr	Nov. '01 to Nov. '02 Mgal/yr	Projected Mgal/yr
Markham Winery	2.25	2.06	2.18	2.4
Freemark Abbey (including Brava Restaurant & Silverado Brewery)	2.50	3.18 <sup>a</sup>	5.24	4.0
Culinary Institute of America	4.56	6.12	5.60	7.7
Wine Country Inn	0.675	1.09 <sup>a</sup>	1.05	1.2
Total	9.985	12.46	14.07	16.07 <sup>b</sup>

a. Flow-metering errors resulted in an increase in reported wastewater flows.

b. Includes a 5 percent increase for unanticipated flows.

## **CAPACITY EVALUATION**

### **POND WATER BALANCE**

A pond water balance (PWB) was developed to determine the performance of the CWMS at the *projected* flows. The PWB incorporates the wastewater flows, rainfall, and evaporation from the aerated pond system. The ability to dispose of the wastewater was determined by the assimilative capacity estimate. The assimilative capacity estimate is determined from the vineyard irrigation demand and the soil percolation rate. The soil percolation rate was obtained from the Napa County Soil Conservation Survey percolation rate (low value of range, 0.6 inches per hour) and was adjusted by a 4.0 percent safety factor to account for typical slow-rate land application design methodology. The irrigation demand was obtained from the Irrigation Training and Research Center's most recent vineyard crop evapotranspiration (ET) data. In order to be conservative and since there is no benefit from the evaporation ponds in the winter the disposal evaluation did not include the evaporation ponds. However, it is recognized that disposing of secondary wastewater to the evaporation ponds will augment the system during the summer months.

A first-order reduction model was used to determine the CWMS BOD removal performance at the *projected* flows. It is estimated that the final BOD will be well below the WDR monthly limit of 40.0 mg/L and that sufficient detention time exists in the ponds. A calculation of BOD removal and detention time is presented in Enclosure C, Sheets 8 and 9. An increase of aeration will be needed in Ponds No. 1 and 2, as outlined below. Aeration requirements were also determined and presented along with the PWB, assimilative capacity and BOD performance model provided in Enclosure C. Application rates are maintained at rates of about 4 inches per month during the growing season and no more than 2.4 inches per month during the dormant season (November through March).

### **RECOMMENDED CAPITAL IMPROVEMENTS**

Improvements to the CWMS required to bring the system up to the *projected* capacity include:

- 1) Aeration at Pond No. 1
  - a) Aerator horsepower should be increased from the existing 35 Hp to 40 Hp with the installation of an additional 5 Hp aerator
- 2) Aeration at Pond No. 2
  - a) Aerator horsepower should be increased from 16 Hp to 31 Hp with the installation of a 15 Hp brush aerator. In addition to satisfying the aeration demand this is anticipated to improve the mixing in the pond
- 3) North Disinfection and Irrigation Disposal System (adjacent to Markham pre-treatment area)
  - a) Utilization of vineyard: The north disinfection and irrigation disposal system must be refurbished, to its original design capacity, in order to expand to the *projected* CWMS capacity

- b) The application rates/effluent applied proposed in CWMS Report Enclosure C, page 10 should be reviewed by the vineyard management consultant
  - c) Disinfection method: chlorination should be performed by hypochlorite to reduce hazardous materials handling requirements (gaseous chlorine is currently installed)
- 4) Transfer station (between Ponds No. 2 and 3A)
- a) The contact tanks are currently undersized to provide the minimum 90-minute modal chlorine contact time, additional tanks could be added or piping should be installed to increase the contact time.
- 5) South Irrigation Disposal System
- a) System Rating: the *projected* peak disposal flow rate is greater than the existing effluent pumping system rating.
    - i) In order to improve system flexibility the South Irrigation Disposal System should be sized for the *projected* peak disposal flow rate. In addition, a connection to the 7.7-acre disposal area (north of Pond No. 1) would allow all disposal to occur from this disposal system. Thereby increasing the ease of operation of the disposal system.
    - ii) The effluent pump and filtration system will need to be upgraded to handle the *projected* peak disposal flow rate
    - iii) The rating of the drip irrigation system (e.g. pipe pressure rating, emitter flow rates, etc.) should be determined from the vineyard management consultant to confirm its ability to accommodate the *projected* peak disposal flow rate.
  - b) The application rates/effluent applied proposed in CWMS Report Enclosure C, page 10 should be reviewed by the vineyard management consultant to confirm its ability to accommodate *projected* peak disposal flow rates.

**SUMMIT ENGINEERING, INC.**  
Consulting Civil Engineers

**MARKHAM COMBINED WASTEWATER MANAGEMENT SYSTEM**

**ENCLOSURE A**

VICINITY MAP  
SITE LAYOUT

COMBINED WASTEWATER MANAGEMENT SYSTEM SCHEMATIC



**SUMMIT ENGINEERING, INC.**  
Consulting Civil Engineers

**MARKHAM COMBINED WASTEWATER MANAGEMENT SYSTEM**

**ENCLOSURE B**

PROJECTED WASTEWATER FLOW CALCULATIONS

**MARKHAM COMBINED  
WASTEWATER MANAGEMENT SYSTEM**

PROJECTED WASTEWATER FLOW CALCULATIONS

Based on existing wastewater flow data, collected at the CWMS for the past six years, and projected expansion plans from each of the USERS and the corresponding process wastewater (PW) and sanitary wastewater (SW) generation rates, the *projected* flows are calculated as follows:

**MARKHAM WINERY**

PROCESS WASTEWATER

Annual Volume

Annual production (projected)	=	2,600 tons/year
Wine generation rate	=	165 gal wine/ton
	=	2,600 tons/year x 165 gal wine/ton
	=	429,000 gal wine/year
PW generation rate (historic)	=	5.0 gal PW/gal wine
Annual PW flow	=	429,000 gal wine x 5.0 gal PW/gal wine
	=	2,145,000 gal PW

Use 2.15 Mgal PW

SANITARY WASTEWATER

SW at the Markham winery consists of wastewater generated from restrooms, laboratory, and kitchen/lunch room facilities. *Projected* SW flows are projected as follows:

Average Day

Full-time employees	26 @ 20 gpcd	=	520
Seasonal employees	4 @ 20 gpcd	=	80
Tasting Visitors	50 @ 2.5 gpcd	=	125
Business Visitors	25 @ 2.5 gpcd	=	<u>62.5</u>
			787.5 gpd

$$50 \text{ weeks} \times 6 \text{ days per week} \times 787.5 \text{ gpd} = \underline{0.24 \text{ Mgal/yr SW}}$$

TOTAL ANNUAL WASTEWATER FLOW

$$\text{PW} + \text{SW} = 2.15 \text{ Mgal/yr} + 0.24 \text{ Mgal/yr} = 2.39 \text{ Mgal/yr}$$

USE 2.4 Mgal/yr

## FREEMARK ABBEY WINERY COMPLEX

The wastewater from the Freemark Abbey Winery (FMA) complex includes wastewater from FMA, Silverado Brewery and Brava Restaurant. For each of these entities and the FMA complex the *projected* PW and SW is calculated below.

### Freemark Abbey Winery

#### PROCESS WASTEWATER

##### Annual Volume

Annual production (projected)	=	1,260 tons/year
Wine generation rate	=	165 gal wine/ton
	=	1,260 tons/year x 165 gal wine/ton
	=	207,900 gal wine/year
PW generation rate (Historic)	=	6.0 gal PW/gal wine
Annual PW flow	=	207,900 gal wine x 6.0 gal PW/gal wine
	=	1,247,400 gal PW

Use 1.25 Mgal PW

#### SANITARY WASTEWATER

SW at the Freemark Abbey Winery consists of wastewater generated from offices, retail shop, restrooms, laboratory, and kitchen/lunch room facilities. *Projected* SW flows are projected as follows:

##### Average Day

Full-time employees	28 @ 20 gpcd	=	560
Seasonal employees	3 @ 20 gpcd	=	60
Retail employees	4 @ 20 gpcd	=	80
Office employees	6 @ 20 gpcd	=	120
Tasting Visitors	100 @ 2.5 gpcd	=	250
Business Visitors	10 @ 2.5 gpcd	=	25
			<u>1,095 gpd</u>

50 weeks x 6 days per week x 1,095 gpd = 0.33 Mgal/yr SW

#### TOTAL ANNUAL WASTEWATER FLOW

PW + SW = 1.25 Mgal/yr + 0.33 Mgal/yr = 1.58 Mgal/yr

**Silverado Brewery**

PROCESS WASTEWATER

Annual Volume

Annual production (projected)	=	20,000 gal beer/year
PW generation rate (Assumed)	=	6 gal PW/gal beer
Annual PW flow	=	20,000 gal beer x 6 gal PW/gal beer
	=	120,000 gal PW

Use 0.12 Mgal PW

SANITARY WASTEWATER

SW at the Silverado Brewery consists of wastewater generated from restrooms, tasting, restaurant and kitchen facilities. *Projected* SW flows are projected as follows:

Average Day

Full-time employees	8 @ 20 gpcd	=	160
Part-time employees	20 @ 20 gpcd	=	400
Restaurant (customers)	150 @ 10 gpcd	=	1,500
Tasting Visitors	100 @ 2.5 gpcd	=	250
Business Visitors	5 @ 2.5 gpcd	=	<u>12.5</u>
			2,322.5 gpd

50 weeks x 6 days per week x 2,322.5 gpd = 0.70 Mgal/yr SW

TOTAL ANNUAL WASTEWATER FLOW

PW + SW = 0.12 Mgal/yr + 0.70 Mgal/yr = 0.82 Mgal/yr

**Brava Restaurant**

SANITARY WASTEWATER

SW at the Brava restaurant will consist of typical wastewater generated from restrooms, restaurant and kitchen facilities. *Projected* SW flows are projected as follows:

Average Day

Full-time employees	20 @ 20 gpcd	=	400
Part-time employees	8 @ 20 gpcd	=	160
Restaurant (customers)	150 @ 10 gpcd	=	<u>1,500</u>
			2,060 gpd

50 weeks x 6 days per week x 2,060 gpd = 0.62 Mgal/yr

**FREEMARK ABBEY COMPLEX (including Brava Restaurant & Silverado Brewery)**

TOTAL ANNUAL WASTEWATER FLOW

Freemark Abbey Winery	1.58 Mgal/yr
Silverado Brewery	0.82 Mgal/yr
Brava Restaurant	<u>0.62 Mgal/yr</u>
Subtotal	3.02 Mgal/yr
Inflow and Infiltration @ 33 percent	<u>1.00 Mgal/yr</u>
Total	4.02 Mgal/yr

Use 4.0 Mgal/yr

**CULINARY INSTITUTE OF AMERICA**

The Culinary Institute of America is proposing an expansion to the restaurant, dormitories and renovations to the still house. More detailed information is available in the Culinary Institute of America Water and Wastewater Phase I Projection, issued on January 14, 2002 by Summit Engineering Inc., supporting calculations of which are provided as an attachment to this document.

SANITARY WASTEWATER

Average Day

From CIA Projections = 7.7 Mgal/yr

**WINE COUNTRY INN**

The current renovation is not anticipated to increase the wastewater flows. In order to provide for potential increased occupancy in the future, potential future development of a spa and past meter inaccuracies, the SW flows from Wine Country Inn (WCI) are *projected* to be 10 percent greater than the historic peak annual flow.

*Projected* Annual SW Flow = Historic Peak Annual SW Flow x 110%  
= 1.087 Mgal/yr x 110%  
= 1.20 Mgal/yr SW

**COMBINED WASTEWATER MANAGEMENT SYSTEM**

Projected Annual Flow

Markham Winery	=	2.4 Mgal/yr
Freemark Abbey Winery Complex (including Brava Restaurant & Silverado Brewery)	=	4.0 Mgal/yr
Culinary Institute of America	=	7.7 Mgal/yr
Wine Country Inn	=	<u>1.2 Mgal/yr</u>
Subtotal Annual Flow	=	15.3 Mgal/yr
5 percent allotment for unanticipated increases	=	<u>0.77 Mgal/yr</u>
Total Annual Flow	=	<b><u>16.07 Mgal/yr</u></b>

**SUMMIT ENGINEERING, INC.**  
Consulting Civil Engineers

**MARKHAM COMBINED WASTEWATER MANAGEMENT SYSTEM**

**ENCLOSURE C**

POND WATER BALANCE

<b>SUMMIT ENGINEERING, INC.</b> Consulting Civil Engineers	<b>MARKHAM CWMS</b> <b>PROJECTED SCENARIO</b> Process Wastewater Design Criteria	<b>PROJECT NO.</b> <b>BY:</b> <b>CHK:</b>	<b>2001075.1</b> <b>AG</b> <b>GD</b>
---	--	---	--

**DESIGN CRITERIA - Projected**

Current (Nov. 00 to Nov. 01) Annual PW Flow	12,425,416 gal PW/year
Flow increase from Current, 2001 level	23.4%
Projected Annual PW Flow	15,331,400 Mgal/yr
Contingency Factor (unanticipated increases)	5.0% (included in flow increase percentage)
Projected Average Day Flow	42,100 gal PW/day
Projected Average Day Peak Harvest Month Flow	48,800 gal PW/day
Projected Average Day Peak Month Flow	54,100 gal PW/day
Pond No. 1 Volume	3.106 Mgal
Pond No. 2 Volume	7.231 Mgal
Pond No. 3A Volume	1.500 Mgal
Pond No. 3B Volume	1.500 Mgal
Total Pond Volume	13.338 Mgal
Pond No. 1 HRT	63.7 days
Pond No. 2 HRT	148.2 days
Pond No. 3A HRT	30.7 days
Pond No. 3B HRT	30.7 days
Total HRT	273.3 days

**HISTORICAL WASTEWATER FLOWS**

Month	CIA	FMA	WCI	Markham	Combined	Monthly Flow (Mgal)
August	9.5%	9.3%	9.2%	8.5%	9.1%	1.13
September	7.9%	8.2%	7.4%	13.2%	9.5%	1.19
October	8.6%	8.0%	6.2%	10.6%	9.3%	1.15
November	6.9%	7.2%	7.9%	7.9%	7.2%	0.90
December	8.6%	8.8%	7.9%	6.6%	7.9%	0.99
January	7.9%	7.9%	7.7%	7.4%	7.7%	0.96
February	10.8%	10.0%	7.3%	9.1%	9.9%	1.23
March	8.2%	8.3%	7.6%	6.4%	7.5%	0.94
April	8.6%	8.7%	13.7%	6.7%	8.2%	1.02
May	7.5%	7.8%	8.8%	8.0%	8.1%	1.01
June	7.6%	7.7%	7.6%	6.8%	7.4%	0.93
July	7.9%	8.0%	8.5%	8.8%	8.1%	1.01
<b>Total</b>	100.0%	100.0%	100.0%	100.0%	100.0%	12.43

a Annual flow and monthly percentages based on wastewater flow data from November 1995 to October 2001.

**PROJECTED WASTEWATER FLOWS**

Month	CIA	FMA	WCI	Markham	Monthly Flow (Mgal)	Total Projected Monthly Flows (Mgal) <sup>b</sup>
August	0.10	0.08	-0.01	0.03	0.20	1.39
September	0.09	0.07	0.00	0.04	0.19	1.46
October	0.09	0.07	0.00	0.03	0.19	1.42
November	0.07	0.06	0.00	0.03	0.16	1.11
December	0.09	0.07	0.00	0.02	0.18	1.22
January	0.09	0.06	0.00	0.02	0.17	1.18
February	0.12	0.08	0.00	0.03	0.23	1.51
March	0.09	0.07	0.00	0.02	0.17	1.15
April	0.09	0.07	-0.01	0.02	0.18	1.26
May	0.08	0.06	-0.01	0.03	0.17	1.24
June	0.08	0.06	0.00	0.02	0.16	1.14
July	0.09	0.07	0.00	0.03	0.18	1.24
<b>Total</b>	1.09	0.82	-0.06	0.33	2.18	15.33

b Total Flow equals Current (11/00 to 10/01) flows plus projected flows and a 5 percent safety factor for unexpected increases in wastewater flows



<b>SUMMIT ENGINEERING, INC.</b> Consulting Civil Engineers	<b>MARKHAM CWMS</b> <b>PROJECTED SCENARIO</b> <b>Aeration Requirements</b>	<b>PROJECT NO.</b> 2001075 <b>BY:</b> AG <b>CHK:</b> GD
---	--	---

**DESIGN CRITERIA - EXISTING**

**Sizing Parameters**

BOD Concentration	2,303 mg/L <sup>a</sup>
Average Day, Peak Harvest Month Flow <sup>b</sup>	48,800 gal PW/day
Oxygen Requirement	1.5 lbs O <sub>2</sub> /lb BOD
Oxygen Transfer Rate (Vertical Turbine Aerator)	2.2 lbs O <sub>2</sub> /HP - hr
Power/ Volume Ratio, Pond No. 1	0.10 - 0.20 Hp/ 1,000 cu ft
Power/ Volume Ratio, Pond No. 2	0.05 - 0.10 Hp/ 1,000 cu ft
Pond No. 1 Volume	3.11 Mgal
Pond No. 2 Volume	7.23 Mgal

**Aeration Pond No. 1**

BOD Mass Loading	938 lbs BOD/day
Aerator Run Time	24 Hrs/day
Oxygen Requirement	59 lbs O <sub>2</sub>
Aerator Horsepower Required	27 Hp (currently using two 10 & a 15 Hp aerators for a total of 35 Hp)
Aerator Horsepower Recommended	40 Hp (can be phased)
Check Power-to-Volume Ratio	0.10 Hp/ 1,000 CF

P\V range desired is 0.10 to 0.20, this will enable oxygen transfer and mixing to occur within the upper 3-4 feet of the pond as required in a facultative aerated lagoon system.

**Aerated Pond No. 2**

Aerator Hp	16 Hp (currently using two 3 & two 5 Hp aerators for a total of 16Hp)
P\V	0.02 Hp/ 1,000 CF
P\V acceptable range is 0.05 - 0.10.	
Aerator Horsepower Recommended	31 Hp (can be phased)
Check Power-to-Volume Ratio	0.03 Hp/ 1,000 CF

- a. BOD value based upon 58 percent of flows from domestic sources at 350 mg/L and 42 percent of flows from winery/brewery operations at 5,000 mg/L.  
 b. The peak hydraulic month is February, the peak BOD month is September.

<b>SUMMIT ENGINEERING, INC.</b> Consulting Civil Engineers	<b>MARKHAM CWMS</b> <b>PROJECTED SCENARIO</b> Climate Data	<b>PROJECT NO.</b> <b>BY:</b> <b>CHK:</b>	<b>2001075.1</b> <b>AG</b> <b>GD</b>
---	--	---	--

Month	Days	Average	Reference	Pan Evaporation <sup>c</sup>	Lake Evaporation <sup>d</sup>	Average Precipitation <sup>e</sup>	10-Year Precipitation <sup>f</sup>	100-Year Precipitation <sup>f</sup>
		Temp <sup>a</sup> (F)	Evapotranspiration <sup>b</sup> (in)					
August	31	70.7	5.9	7.2	5.5	0.1	0.2	0.2
September	30	67.6	5.2	6.4	4.9	0.3	0.4	0.6
October	31	61.7	3.3	3.9	3.0	1.8	2.6	3.4
November	30	52.3	1.1	1.9	1.5	4.0	5.7	7.5
December	31	46.6	1.2	1.4	1.1	6.5	9.3	12.2
January	31	46.0	0.8	1.5	1.2	7.9	11.3	14.9
February	28	50.2	2.3	2.0	1.5	5.8	8.3	10.9
March	31	52.3	3.6	3.4	2.6	4.8	6.8	9.0
April	30	56.3	5.2	4.2	3.2	2.2	3.1	4.1
May	31	62.4	6.7	5.9	4.5	0.7	1.0	1.3
June	30	68.0	7.0	6.5	5.0	0.2	0.3	0.4
July	31	71.1	6.9	8.9	6.9	0.0	0.0	0.0
<b>Total</b>	<b>365</b>		<b>49.2</b>	<b>53.2</b>	<b>41.0</b>	<b>34.4</b>	<b>49.0</b>	<b>64.7</b>

<sup>a</sup> Average monthly temperature observed between 1961 and 1995, for St. Helena, CA. See <http://www.worldclimate.com>

<sup>b</sup> Average monthly reference evaporation rates for Zone 8, Inland San Francisco Bay Area, typical rainfall year, CIMIS, DWR, 2001. See [www.itrc.org](http://www.itrc.org).

<sup>c</sup> Average monthly pan evaporation rates observed at Yountville, CA between 1962 and 1969.

<sup>d</sup> Pan evaporation rates adjusted by a factor of 0.77 to determine lake evaporation.

<sup>e</sup> Average monthly rainfall observed between 1931 and 1995, for St. Helena, CA. See <http://www.worldclimate.com>

<sup>f</sup> Average monthly rainfall adjusted by the ratio of 10-yr and 100-yr wet year return storm identified by Pearsons Log III Distribution.

<b>SUMMIT ENGINEERING, INC.</b> Consulting Civil Engineers	<b>MARKHAM CWMS</b> <b>PROJECTED SCENARIO</b> Ponds No. 1 & 2 Worksheet	<b>PROJECT NO.</b> <b>BY:</b> <b>CHK:</b>	<b>2001075.1</b> <b>AG</b> <b>GD</b>
---	---	---	--

<b><u>Pond No. 1</u></b>					
Bottom Width	N/A	Bottom Radius	N/A	Start Month	August
Bottom Length	N/A	Top Radius	N/A	Min. Depth	5.0'
Interior Side Slope (x:1)	N/A	Depth	10.0'	Annual PW	15.33 Mgal
Length:Width	N/A	Freeboard	2.0'	Initial Depth	10.0'

Depth (ft)	Surface Area <sup>a</sup> (ft <sup>2</sup> )	Total Volume (Mgal)
0	27,632	0.000
1	30,388	0.217
2	33,248	0.455
3	36,209	0.715
4	39,272	0.997
5	42,434	1.303
6	45,698	1.632
7	47,482	1.981
8	49,266	2.343
9	51,041	2.718
10	52,817	3.106
11	54,314	3.507
12	55,811	3.919

<b><u>Pond No. 2</u></b>					
Bottom Width	N/A	Bottom Radius	N/A	Start Month	August
Bottom Length	N/A	Top Radius	N/A	Min. Depth	3.0'
Interior Side Slope (x:1)	N/A	Depth	10.0'	Divert Volume	15.69 Mgal
Length:Width	N/A	Freeboard	2.0'	Initial Depth	5.0'

Depth (ft)	Surface Area <sup>a</sup> (ft <sup>2</sup> )	Total Volume (Mgal)
0	76,296	0.000
1	80,422	0.586
2	84,616	1.203
3	88,879	1.852
4	93,212	2.533
5	97,611	3.247
6	102,079	3.994
7	105,121	4.769
8	108,162	5.567
9	111,264	6.387
10	114,365	7.231
11	117,086	8.097
12	119,807	8.983

a. Pond surface areas from Wastewater Feasibility Report for The Culinary Institute of America, by Summit Engineering, May 1993.

<b>SUMMIT ENGINEERING, INC.</b> Consulting Civil Engineers	<b>MARKHAM CWMS</b> <b>PROJECTED SCENARIO</b> <b>Ponds No. 3A &amp; 3B Worksheet</b>	<b>PROJECT NO.</b> 2001075.1
		<b>BY:</b> AG <b>CHK:</b> GD

<b><u>Pond No. 3A</u></b>					
Bottom Width	85.2'	Bottom Radius	15.0'	Start Month	August
Bottom Length	85.2'	Top Radius	35.0'	Min. Depth	3.0'
Interior Side Slope (x:1)	3.0	Depth	15.0'	Divert Volume	16.69 Mgal
Length:Width	1.0	Freeboard	2.0'	Initial Depth	5.0'

Depth (ft)	Length (ft)	Width (ft)	Radius (ft)	Surface Area (ft <sup>2</sup> )	Total Volume (Mgal)
0	85	85	15	7,059	0.000
1	91	91	16	8,081	0.057
2	97	97	18	9,173	0.121
3	103	103	19	10,333	0.194
4	109	109	20	11,562	0.276
5	115	115	22	12,860	0.367
6	121	121	23	14,227	0.469
7	127	127	24	15,663	0.580
8	133	133	26	17,168	0.703
9	139	139	27	18,742	0.838
10	145	145	28	20,384	0.984
11	151	151	30	22,096	1.143
12	157	157	31	23,877	1.315
13	163	163	32	25,727	1.500
14	169	169	34	27,645	1.700
15	175	175	35	29,633	1.914

<b><u>Pond No. 3B</u></b>					
Bottom Width	85.2'	Bottom Radius	15.0'	Start Month	August
Bottom Length	85.2'	Top Radius	35.0'	Min. Depth	3.0'
Interior Side Slope (x:1)	3.0	Depth	15.0'	Divert Volume	17.17 Mgal
Length:Width	1.0	Freeboard	2.0'	Initial Depth	7.0'

Depth (ft)	Length (ft)	Width (ft)	Radius (ft)	Surface Area (ft <sup>2</sup> )	Total Volume (Mgal)
0	85	85	15	7,059	0.000
1	91	91	16	8,081	0.057
2	97	97	18	9,173	0.121
3	103	103	19	10,333	0.194
4	109	109	20	11,562	0.276
5	115	115	22	12,860	0.367
6	121	121	23	14,227	0.469
7	127	127	24	15,663	0.580
8	133	133	26	17,168	0.703
9	139	139	27	18,742	0.838
10	145	145	28	20,384	0.984
11	151	151	30	22,096	1.143
12	157	157	31	23,877	1.315
13	163	163	32	25,727	1.500
14	169	169	34	27,645	1.700
15	175	175	35	29,633	1.914

SUMMIT ENGINEERING, INC. Consulting Civil Engineers	MARKHAM CWMS PROJECTED SCENARIO Pond Water Balance	PROJECT NO.	2001075
		BY:	AG
		CHK:	GD

**Pond No. 1**

Month	Initial Volume	Pond Evaporation	PW Inflow	10 Year Precipitation	Volume Change	Total Volume	Divert Volume	Final Volume	Final Pond Depth
	(Mgal)	(Mgal)	(Mgal)	(Mgal)	(Mgal)	(Mgal)	(Mgal)	(Mgal)	(ft)
August	3.106	-0.182	1.391	0.005	1.215	4.322	1.215	3.106	10.0
September	3.106	-0.162	1.463	0.015	1.316	4.423	1.316	3.106	10.0
October	3.106	-0.098	1.419	0.089	1.410	4.517	1.410	3.106	10.0
November	3.106	-0.048	1.106	0.199	1.256	4.363	1.256	3.106	10.0
December	3.106	-0.036	1.217	0.323	1.503	4.610	1.503	3.106	10.0
January	3.106	-0.039	1.179	0.392	1.533	4.639	1.533	3.106	10.0
February	3.106	-0.051	1.513	0.288	1.750	4.856	1.750	3.106	10.0
March	3.106	-0.086	1.154	0.238	1.307	4.413	1.307	3.106	10.0
April	3.106	-0.107	1.263	0.109	1.265	4.371	1.265	3.106	10.0
May	3.106	-0.150	1.241	0.035	1.126	4.233	1.126	3.106	10.0
June	3.106	-0.166	1.142	0.010	0.986	4.093	0.986	3.106	10.0
July	3.106	-0.226	1.244	0.000	1.019	4.125	1.019	3.106	10.0
<b>Total</b>		<b>-1.349</b>	<b>15.331</b>	<b>1.705</b>	<b>15.687</b>		<b>15.687</b>		

**Pond No. 2**

Month	Initial Volume	Pond Evaporation	PW Inflow	10 Year Precipitation	Volume Change	Total Volume	Divert Volume	Final Volume	Final Pond Depth
	(Mgal)	(Mgal)	(Mgal)	(Mgal)	(Mgal)	(Mgal)	(Mgal)	(Mgal)	(ft)
August	3.247	-0.335	1.215	0.012	0.892	4.139	1.600	2.539	4.0
September	2.539	-0.285	1.316	0.033	1.064	3.603	0.100	3.503	5.3
October	3.503	-0.183	1.410	0.192	1.419	4.921	0.300	4.621	6.8
November	4.621	-0.095	1.256	0.426	1.588	6.209	1.600	4.609	6.7
December	4.609	-0.071	1.503	0.693	2.125	6.734	1.400	5.334	7.7
January	5.334	-0.079	1.533	0.842	2.295	7.629	1.400	6.229	8.8
February	6.229	-0.107	1.750	0.618	2.261	8.490	1.200	7.290	10.0
March	7.290	-0.186	1.307	0.511	1.632	8.922	1.900	7.022	9.7
April	7.022	-0.230	1.265	0.234	1.270	8.292	1.500	6.792	9.4
May	6.792	-0.319	1.126	0.076	0.883	7.675	2.200	5.475	7.8
June	5.475	-0.338	0.986	0.022	0.671	6.147	2.200	3.947	5.9
July	3.947	-0.434	1.019	0.001	0.586	4.532	1.285	3.247	4.9
<b>Total</b>		<b>-2.662</b>	<b>15.687</b>	<b>3.660</b>	<b>16.685</b>		<b>16.685</b>		

<b>SUMMIT ENGINEERING, INC.</b> Consulting Civil Engineers	<b>MARKHAM CWMS</b> <b>PROJECTED SCENARIO</b> <b>Pond Water Balance</b>	<b>PROJECT NO.</b> 2001075 <b>BY:</b> AG <b>CHK:</b> GD
---	---	---

**Pond No. 3A**

Month	Initial Volume (Mgal)	Pond Evaporation (Mgal)	PW Inflow (Mgal)	10 Year Precipitation (Mgal)	Volume Change (Mgal)	Total Volume (Mgal)	Divert Volume (Mgal)	Final Volume (Mgal)	Final Pond Depth (ft)
August	0.357	-0.044	1.600	0.003	1.559	1.926	1.720	0.206	3.1
September	0.206	-0.032	0.100	0.008	0.076	0.282	0.080	0.202	3.1
October	0.202	-0.019	0.300	0.047	0.328	0.530	0.310	0.220	3.3
November	0.220	-0.010	1.600	0.105	1.696	1.916	0.900	1.016	10.2
December	1.016	-0.014	1.400	0.171	1.557	2.573	1.450	1.123	10.8
January	1.123	-0.016	1.400	0.208	1.592	2.715	1.330	1.385	12.3
February	1.385	-0.024	1.200	0.153	1.329	2.715	1.200	1.515	13.0
March	1.515	-0.042	1.900	0.127	1.985	3.499	2.000	1.499	12.9
April	1.499	-0.052	1.500	0.058	1.506	3.006	2.200	0.806	8.7
May	0.806	-0.052	2.200	0.019	2.167	2.973	2.400	0.573	6.9
June	0.573	-0.049	2.200	0.006	2.157	2.729	2.140	0.589	7.0
July	0.589	-0.067	1.285	0.000	1.219	1.808	1.441	0.367	5.0
<b>Total</b>		<b>-0.420</b>	<b>16.685</b>	<b>0.905</b>	<b>17.171</b>		<b>17.171</b>		

**Pond No. 3B**

Month	Initial Volume (Mgal)	Pond Evaporation (Mgal)	PW Inflow (Mgal)	10 Year Precipitation (Mgal)	Volume Change (Mgal)	Total Volume (Mgal)	Divert to Irrigation Volume (Mgal)	Divert to Evap Ponds Volume (Mgal)	Total Divert Volume (Mgal)	Final Volume (Mgal)	Final Pond Depth (ft)
August	0.357	-0.054	1.720	0.003	1.669	2.250	2.050	0.000	2.050	0.200	3.0
September	0.200	-0.032	0.080	0.008	0.057	0.256	0.060	0.000	0.060	0.196	3.0
October	0.196	-0.019	0.310	0.047	0.338	0.534	0.340	0.000	0.340	0.194	3.0
November	0.194	-0.009	0.900	0.105	0.996	1.190	0.990	0.000	0.990	0.200	3.0
December	0.200	-0.007	1.450	0.171	1.614	1.815	1.200	0.000	1.200	0.615	7.2
January	0.615	-0.012	1.330	0.208	1.526	2.141	1.200	0.000	1.200	0.941	9.7
February	0.941	-0.019	1.200	0.153	1.334	2.275	1.200	0.000	1.200	1.075	10.5
March	1.075	-0.035	2.000	0.127	2.092	3.167	1.650	0.000	1.650	1.517	13.0
April	1.517	-0.052	2.200	0.058	2.206	3.723	3.300	0.000	3.300	0.423	5.5
May	0.423	-0.038	2.400	0.019	2.380	2.803	2.600	0.000	2.600	0.203	3.1
June	0.203	-0.033	2.140	0.006	2.113	2.316	2.110	0.000	2.110	0.206	3.1
July	0.206	-0.045	1.441	0.000	1.397	1.602	1.400	0.000	1.400	0.202	3.1
<b>Total</b>		<b>-0.354</b>	<b>17.171</b>	<b>0.905</b>	<b>17.722</b>		<b>18.100</b>	<b>0.000</b>	<b>18.100</b>		

Infiltration rate 1.0 x 10<sup>-6</sup> cm/s through the pond liner

SUMMIT ENGINEERING, INC. Consulting Civil Engineers	MARKHAM CWMS PROJECTED SCENARIO Pond Performance Worksheet <sup>a</sup>	PROJECT NO.	2001075.1
		DATE:	AG
		BY:	GD

**ASSUMPTIONS**

Influent water temperature      65 deg. F  
 $K_{20} =$                               0.276  $d^{-1}$   
 Temperature coefficient        1.036

Month	POND NO. 1							POND NO. 2				
	Ambient Air Temperature (deg. F)	BOD <sup>b</sup> (mg/L)	Flow <sup>c</sup> (gpd)	Hydraulic Detention Time <sup>d</sup> (d)	Water Temperature <sup>e</sup> (deg. F)	Effluent BOD <sup>f</sup> (mg/L)	BOD Removal Performance	Flow <sup>c</sup> (gpd)	Hydraulic Detention Time <sup>d</sup> (d)	Water Temperature <sup>e</sup> (deg. F)	Effluent BOD <sup>f</sup> (mg/L)	BOD Removal Performance
August	71	2,303	39,208	74	67	109	95%	28,764	64	67	6	95%
September	68	2,303	43,879	67	66	123	95%	35,465	128	66	4	97%
October	62	2,303	45,490	68	64	126	95%	45,764	147	64	3	97%
November	52	2,303	41,877	79	60	117	95%	52,924	97	60	5	96%
December	47	1,043	48,489	71	59	61	94%	68,541	106	59	2	96%
January	46	1,043	49,438	71	58	61	94%	74,036	122	58	2	97%
February	50	1,043	62,499	53	61	76	93%	80,759	128	61	2	97%
March	52	1,043	42,151	78	60	53	95%	52,647	138	60	2	97%
April	56	1,043	42,170	74	62	55	95%	42,325	150	62	1	97%
May	62	1,043	36,332	81	64	48	95%	28,494	114	64	2	97%
June	68	1,043	32,878	88	66	43	96%	22,369	89	66	2	96%
July	71	1,043	32,872	85	68	43	96%	18,901	97	68	2	96%
<b>AVERAGE</b>		<b>1,463</b>	<b>42,620</b>	<b>76</b>	<b>63</b>	<b>54</b>	<b>95%</b>	<b>45,916</b>	<b>120</b>	<b>63</b>	<b>2</b>	<b>97%</b>

a Partial-Mix, First Order Reduction Model

b BOD during harvest approximately 2,303 mg/L (see Aeration Requirements). Non-harvest BOD of 1,043 from 58 percent of flows domestic with a BOD of 350 mg/L and 42 percent of flows winery/brewery at 2,000 mg/L.

c Volume change values from water balance.

d HRT determined as average of starting and ending monthly pond volume divided by average of monthly inflow and outflow.

e Pond water temperature determined using Eq 8-5 in Tchobanoglous, 1998.

f Effluent BOD determined using a first-order reduction, partial mix model, Eq. 8-4 in Tchobanoglous, 1998.

SUMMIT ENGINEERING, INC. Consulting Civil Engineers	MARKHAM CWMS PROJECTED SCENARIO Pond Performance Worksheet <sup>a</sup>	PROJECT NO.	2001075.1
		DATE:	AG
		BY:	GD

**ASSUMPTIONS**

Influent water temperature 65 deg. F  
 $K_{20} = 0.276 \text{ d}^{-1}$   
 Temperature coefficient 1.036

Month	POND NO. 3A							POND NO. 3B				
	Ambient Air Temperature (deg. F)	BOD <sup>b</sup> (mg/L)	Flow <sup>c</sup> (gpd)	Hydraulic Detention Time <sup>d</sup> (d)	Water Temperature <sup>e</sup> (deg. F)	Effluent BOD <sup>f</sup> (mg/L)	BOD Removal Performance (%)	Flow <sup>c</sup> (gpd)	Hydraulic Detention Time <sup>d</sup> (d)	Water Temperature <sup>e</sup> (deg. F)	Effluent BOD <sup>f</sup> (mg/L)	BOD Removal Performance (%)
August	71	6	50,281	5	66	2	59%	53,841	6	66	1	63%
September	68	4	2,539	68	67	0	95%	1,884	85	67	0	96%
October	62	3	10,583	21	64	1	85%	10,913	19	64	0	83%
November	52	5	56,524	15	64	1	79%	33,202	6	64	0	61%
December	47	2	50,232	23	62	0	85%	52,073	10	62	0	70%
January	46	2	51,359	28	62	0	87%	49,239	19	62	0	82%
February	50	2	47,475	34	62	0	89%	47,632	24	62	0	85%
March	52	2	64,021	24	63	0	86%	67,483	22	63	0	85%
April	56	1	50,208	19	63	0	82%	73,529	11	63	0	73%
May	62	2	69,903	9	65	0	71%	76,787	4	65	0	50%
June	68	2	71,894	8	65	1	68%	70,424	3	65	0	43%
July	71	2	39,318	11	66	0	74%	45,052	4	66	0	54%
<b>AVERAGE</b>		<b>3</b>	<b>56,311</b>	<b>19</b>	<b>64</b>	<b>0</b>	<b>80%</b>	<b>48,505</b>	<b>12</b>	<b>64</b>	<b>0</b>	<b>67%</b>

a Partial-Mix, First Order Reduction Model

b BOD influent from Pond No. 2

c Volume change values from water balance.

d HRT determined as average of starting and ending monthly pond volume divided by average of monthly inflow and outflow.

e Pond water temperature determined using Eq 8-5 in Tchobanoglous, 1998.

f Effluent BOD determined using a first-order reduction, partial mix model, Eq. 8-4 in Tchobanoglous, 1998.



<b>SUMMIT ENGINEERING, INC.</b> Consulting Civil Engineers	<b>MARKHAM CWMS</b> <b>PROJECTED SCENARIO</b> Irrigation & Effluent Application Rates	<b>PROJECT NO.</b> <b>2001075</b> <b>BY:</b> <b>AG</b> <b>CHK:</b> <b>GD</b>
---	---	--

<b>Applied Irrigation Area</b>	Vineyard	22.6	acres
	Pasture	0.0	acres
<b>Total Area Available for Irrigation</b>	Vineyard	22.6	acres
	Pasture	0.0	acres

Month	Reference ET <sup>a</sup>	Pasture Crop Coefficient <sup>b</sup>	Vineyard Crop Coefficient <sup>c</sup>	Pasture ET <sup>d</sup>	Vineyard ET <sup>d</sup>	Precipitation <sup>e</sup>	Irrigation Demand <sup>f</sup>		Operating Days per Month <sup>g</sup>	Percolation Capacity <sup>h</sup>		Assimilative Capacity <sup>i</sup>		Effluent Applied <sup>j</sup>		Excess Capacity
	(in)			(in)	(in)	(in)	(in)	(Mgal)	(d)	(in)	(Mgal)	(in)	(Mgal)	(Mgal)	(in)	(Mgal)
August	5.9	0.9	0.4	5.3	2.6	0.2	2.4	1.470	31	17.86	10.965	20.2	12.435	2.050	3.34	10.38
September	5.2	0.9	0.3	4.7	1.4	0.4	1.0	0.613	30	17.28	10.611	18.3	11.224	0.060	0.10	11.16
October	3.3	0.9	0.6	3.0	1.9	2.6	0.0	0.000	16	9.22	5.659	9.2	5.659	0.340	0.55	5.32
November	1.1	0.8	0.9	0.8	0.9	5.7	0.0	0.000	14	8.06	4.952	8.1	4.952	0.990	1.61	3.96
December	1.2	0.8	0.9	1.0	1.1	9.3	0.0	0.000	5	2.88	1.769	2.9	1.769	1.200	1.96	0.57
January	0.8	0.8	0.6	0.6	0.4	11.3	0.0	0.000	6	3.46	2.122	3.5	2.122	1.200	1.96	0.92
February	2.3	0.8	0.4	1.8	0.9	8.3	0.0	0.000	5	2.88	1.769	2.9	1.769	1.200	1.96	0.57
March	3.6	0.8	0.7	2.9	2.7	6.8	0.0	0.000	12	6.91	4.245	6.9	4.245	1.650	2.69	2.59
April	5.2	0.9	0.7	4.7	3.5	3.1	0.3	0.191	13	7.49	4.598	7.8	4.789	3.300	5.38	1.49
May	6.7	0.9	0.5	6.0	3.2	1.0	2.2	1.355	16	9.22	5.659	11.4	7.015	2.600	4.24	4.41
June	7.0	0.9	0.4	6.3	2.6	0.3	2.3	1.437	17	9.79	6.013	12.1	7.450	2.110	3.44	5.34
July	6.9	0.9	0.4	6.2	3.0	0.0	3.0	1.840	30	17.28	10.611	20.3	12.451	1.400	2.28	11.05
<b>Total</b>	<b>49.2</b>			<b>43.4</b>	<b>24.3</b>	<b>49.0</b>	<b>11.2</b>	<b>6.9</b>	<b>195.0</b>	<b>112.3</b>	<b>69.0</b>	<b>123.6</b>	<b>75.9</b>	<b>18.1</b>	<b>29.5</b>	<b>57.78</b>

- (a) Average monthly reference evapotranspiration rates, see Climate Data Worksheet.
- (b) Kc coefficients for pasture from Table 5-1, "Irrigation with Reclaimed Municipal Wastewater-A Guidance Manual"- California State Water Resources Control Board, July 1984 (San Joaquin Valley).
- (c) Kc coefficients for vineyards determined from ETc of vineyard and reference ET. See www.itrc.org
- (d)  $ET_c = ET_o \times K_c$ . A weighted value is determined on the basis of the available irrigated acreage of vineyard and pasture.
- (e) Precipitation, 10-year rainfall event, see Climate Data Worksheet.
- (f) Irrigation Demand = ET-Precipitation, inches. A weighted value is determined on the basis of the available irrigated acreage of vineyard and pasture.
- (g) Number of operating days per month based on estimated irrigation days available based on 24-hr post storm criteria for a 100-year return period. Summit Engineering, NBRID Capacity Study, April 1996.
- (h) Design percolation rate is a maximum of 0.58 inches per day for the number of operating day per month. Design perc rate based on permeability rate range of 0.6 to 2.0 inches per hour from Napa County Soil Survey the low of 0.6 inches per hour was adjusted by a 0.04 safety factor to 1.25 inches per day, to account for typical slow rate land application design methodology.
- (i) Assimilative capacity is the sum of irrigation demand and percolation applied.
- (j) Rate of effluent applied to be less than 2.4 inches per month during the winter months and 4 to 6 inches per month during the remainder of the year, as per RWQCB WDRS

CALIFORNIA REGIONAL WATER QUALITY CONTROL BOARD  
SAN FRANCISCO BAY REGION

ORDER NO. 98-064

WASTE DISCHARGE REQUIREMENTS FOR:

CULINARY INSTITUTE OF AMERICA, A NEW YORK CORPORATION; WINE COUNTRY INN, A CALIFORNIA LIMITED PARTNERSHIP; FREEMARK ABBEY WINERY, A CALIFORNIA LIMITED PARTNERSHIP; AND MARKHAM WINERY, A WYOMING CORPORATION; IN NAPA COUNTY

The California Regional Water Quality Control Board, San Francisco Bay Region (hereinafter called the Board), finds that:

1. The Culinary Institute of America, Markham Winery, Freemark Abbey Winery and Wine Country Inn (hereinafter called the Dischargers), collectively use a wastewater pond system located on the Markham Winery property at 2812 St. Helena Highway, about one mile north of the City of St. Helena, for treatment of combined winery process and domestic wastewater and disposal of treated wastewater to land.
2. The Culinary Institute of America, also known as the "Greystone Cellars, on behalf of the dischargers, submitted technical reports entitled *Wastewater Feasibility Report* and *Addendum*, dated May 18, 1993 and May 24, 1993, respectively. These reports describes changes to the previously existing combined wastewater system serving the Freemark Abbey Winery, the Markham Winery and the Wine Country Inn facilities. The Greystone facility had discharged to a separate system permitted to the former owners, the Christian Brothers. The purpose of these changes was to provide a single combined wastewater treatment and disposal system to serve all four facilities.
3. The existing combined wastewater system serving Freemark Abbey Winery, Markham Winery and Wine Country Inn is currently regulated under waste discharge requirements in Order No. 89-054, adopted by the Board on April 19, 1989. The previously existing wastewater system serving the Greystone facility, which was formerly a wine production facility, was regulated by waste discharge requirements in Order No. 82-013, adopted by the Board on March 17, 1982. The purpose of this current Order is to prescribe updated waste discharge requirements for the new combined wastewater system which serves all four facilities. This Order rescinds and supersedes the existing Orders No. 89-054 and 82-013.
4. The Wine Country Inn is a 25-unit bed and breakfast facility located at 1152 Lodi Lane, St. Helena, about one half mile north of the Markham Winery facility. Domestic wastewater collected in a sump and pumped to the Markham ponds via an underground sewer line which is used jointly with the Freemark Abbey Winery.
5. The Freemark Abbey Winery is located at 3022 St. Helena Highway, north of Lodi Lane, adjacent to the Wine Country Inn property. The Freemark Abbey Winery complex includes

facilities for wine production (crushing, fermentation, aging, bottling and storage), wine tasting and retail sales, two restaurants, a candle factory and gift shop, and rented office space. The winery crushes 400 to 500 tons of grapes per year for production of up to about 80,000 gallons of wine per year. Combined domestic and winery wastewater is pumped from the facilities directly to the pond system located on the Markham property.

6. The Markham Winery is located at 2812 St. Helena Highway and includes wine production (crushing, fermentation, aging, bottling and storage), wine tasting and retail sales facilities. The winery has a permitted throughput of 2000 tons of grapes per year, for production of about 300,000 gallons of wine per year. Domestic and wastewater is discharged to the ponds onsite, along with the process wastewater.

7. The Culinary Institute of America (CIA) facility is located at 100 South St. Helena Highway, at the historic building and grounds known as Greystone Cellars. Greystone Cellars was formerly a winery production facility owned and operated by the Christian Brothers. The facility was purchased by CIA in 1992, and converted to a culinary education facility. The CIA facility currently consists of culinary teaching facilities, restaurant, student and faculty lodging, etc.

8. The projected annual wastewater generation rates for the Dischargers' facilities described above are tabulated below (in million gallons per year):

	<i>Domestic</i>	<i>Winery</i>	<i>Design Total</i>
Wine Country Inn	0.675	Ø	0.675
Freemark Abbey Winery	2.00	0.50	2.50
Markham Winery	0.33	1.92	2.25
Culinary Institute-Greystone	5.42	Ø	5.42
<b>Total</b>	<b>8.395</b>	<b>2.42</b>	<b>10.845</b>

9. Collected wastewater from the above facilities is discharged into two ponds on Markham Winery property (No 1 and No. 2, see attached map). The ponds are equipped with two mechanical aerators. The ponds are in series with the first pond supplying the majority of the needed aeration and residence time. The ponds each have a total depth of about twelve feet. With two feet of freeboard, the smaller pond has a storage volume of 2.6 million gallons, and the larger pond has about 6.1 million gallons of storage capacity.

10. Pond effluent is pumped through a pressure sand filter prior to disinfection by chlorination. Filtered, disinfected effluent is stored in either a steel irrigation tank or a two compartment storage pond that has a volume of 3.11 million gallons. Water from the storage tank is filtered and pumped to drip irrigation system on 7.7 acres of vineyard. Water from the storage pond is pumped to a drip irrigation system situated on 14.9 acres of vineyard. The drip irrigation vineyards are located adjacent and to the north and south of the wastewater ponds, on property owned by the Freemark Abbey Winery and the Institute (see attached map).

11. A set of two evaporation ponds were added to the system in 1993 to allow for contingent disposal of water by evaporation. The ponds are located east of the treatment ponds, adjacent to

the Napa River, on property owned by the Institute. There is no discharge from the evaporation ponds. These ponds are approximately 2.6 acres in size.

12. The drip irrigation area will be appropriately fenced to restrict public access and bermed to prevent off-site runoff of reclaimed water. A map showing the locations of the existing facilities and the proposed drip irrigation area is included as Attachment A of this Order.

13. Effluent will be applied to the vineyards at rates of about 4 to 6 inches per month during the growing season, and no more than 2.4 inches per month during the dormant season (November through February). Irrigation of the vineyards will be suspended at least 30 days prior to and during harvest, in order to prevent contact with reclaimed water during harvest.

14. A water balance analysis of the treatment pond and drip irrigation system indicates that, with proper operation and management, the system will have adequate capacity to handle the design wastewater flows described in Finding 14 above, and direct precipitation of a 10-year recurrence interval rainfall record.

15. The Dischargers developed an easement agreement, with Markham Winery at the owner of the ponds and Freemark Abbey Winery and Wine Country Inn and Culinary Institute as dischargers of wastewater to the system.

16. A residence which is served by a domestic water supply well is located among the vineyards to the north of the drip irrigation field. A minimum setback distance of 100 feet will be maintained between the drip irrigation field and the domestic water well.

17. A 12-inch diameter water main, which is buried at least three feet below the ground surface, traverses the eastern portion of the drip irrigation area, in a north-south direction. This pipe transports potable water to the City of Calistoga. A minimum setback distance of 20 feet will be maintained between areas irrigated with reclaimed water and the line of this water supply main.

18. Solid waste produced at the Freemark Abbey Winery and the Markham Winery from wine production operations, consisting primarily of pomace, seeds and stems, will be spread and disked into the soils on approximately 10.5 acres of vineyard owned by Freemark Abbey Winery. These solid wastes would be produced at an estimated rate of about 325 tons (about 320 cubic yards) per year, at the wineries' ultimate capacity. Septic and settling tank solids will be pumped out by a licensed septic tank service and hauled away for disposal at an authorized site.

19. The Board adopted a revised Water Quality Control Plan for the San Francisco Bay Basin (Basin Plan) on June 21, 1995. This updated and consolidated plan represents the Board's master water quality control planning document. The revised Basin Plan was approved by the State Water Resources Control Board (SWRCB) and the Office of Administrative Law on July 20, 1995 and November 13, 1995, respectively. A summary of the regulatory provisions is contained in Title 23 of the California Code of Regulations, Section 3912. The Basin Plan identifies beneficial uses and water quality objectives for waters of the state in the Region, including surface waters and groundwaters. The Basin Plan also identifies effluent limitations and discharge prohibitions intended to protect beneficial uses. This Order implements the plans, policies and provisions of the Board's Basin Plan.

20. The Basin plan contains a listing of beneficial uses of the Napa River and groundwaters in the Napa Valley area. The beneficial uses of the Napa River downstream from the vicinity of the Dischargers' wastewater system, as set forth in the Basin Plan, include:

- a. Navigation
- b. Water Contact Recreation
- c. Non-Contact Water Recreation
- d. Warm Fresh Water Habitat
- e. Cold Fresh Water Habitat
- f. Wildlife Habitat
- g. Preservation of Rare and Endangered Species
- h. Fish Migration and Spawning
- i. Municipal and Domestic Supply
- j. Agricultural Supply

21. The beneficial uses of groundwaters in the Napa Valley area, as set forth in the Basin Plan, include:

- a. Municipal Supply
- b. Industrial Process Water Supply
- c. Industrial Service Supply
- d. Agricultural Supply.

22. The Dischargers upgraded the wastewater system formerly permitted under Board Order 89-054 in order to consolidate the treatment of all wastewater from the Greystone facility, as well as the existing permitted wastewater flows from the other three facilities. Wastewater system modifications included conversion of process wastewater ponds to accept domestic wastewater, and an increased effluent disposal capacity by drip irrigation of vineyards. The conversion of the Greystone building to its current use was approved by the City of St. Helena on September 14, 1993. As part of the change in land use, City of St. Helena certified an Environmental Impact Report (January 5, 1993, DEIS and Mitigation Monitoring Plan). The significant impacts related to wastewater were mitigated by through the proper operation and management of sewage sludge, effluent percolation rates and contact with drip irrigation water. These mitigation measures are also addressed by the requirements contained in this order.

23. The Board has notified the Dischargers and interested agencies and persons of its intent to prescribe waste discharge requirements for the discharge and has provided them with an opportunity for a public hearing and an opportunity to submit written views and recommendations.

24. The Board, in a public hearing, heard and considered all comments pertaining to the discharge.

IT IS HEREBY ORDERED, that the Dischargers, pursuant to the provisions contained in Division 7 of the California Water Code and regulations adopted thereunder, shall comply with the following:

A. Prohibitions

1. Wastewater discharged to the treatment ponds shall not exceed the total annual design flows of 10.9 million gallons per year (MGY) as described in Finding 8 of this Order.
2. No wastewater shall be applied to the drip irrigation area when soils are saturated, when conditions are such that runoff or ponding is likely to occur, during rainfall, or when rainfall is expected to occur within 24 hours.
3. Neither the treatment nor the disposal of wastes shall create a nuisance or pollution as defined in the California Water Code.
4. There shall be no bypass or overflow of waste to waters of the State from the Dischargers' wastewater collection, treatment, storage or disposal facilities.
5. Discharge of toxic substances into the ponds which will disturb the normal biological treatment mechanisms of the ponds is prohibited.
6. The discharge of waste shall not degrade the quality of any groundwater used for domestic purposes or cause an increase in any quality parameter that would make groundwater unsuitable for irrigation use.
7. No reclaimed water shall be allowed to escape from the designated use area via surface flow.
8. Reclaimed water shall not be used as a domestic or animal water supply. There shall be no cross-connection between potable water supply and piping containing reclaimed water. Supplementing reclaimed water with water used for domestic supply shall not be allowed except through an air-gap separation.
9. Reclaimed water shall not be discharged onto any facility or area not designated for reclamation such as walkways, passing vehicles, buildings, domestic water facilities or food handling facilities. Drinking water facilities shall be protected from reclaimed water contact.

B. Discharge Specifications

General

1. All wastewater streams discharging into the ponds shall be measured in order to monitor the total flow rate of wastewater discharged into the ponds.

2. The use of reclaimed water shall be limited to drip irrigation of the vineyard area described in Finding 9 and as shown on Attachment A of this Order, unless written authorization is obtained from this Board's Executive Officer.
3. The wastewater ponds, and areas irrigated with reclaimed water shall be adequately fenced to restrict public access.
4. Conspicuous warning signs shall be posted around the ponds and the irrigation field informing the public that the water contained therein is reclaimed water which is not safe for drinking or contact. Signs shall be of sufficient size and proper wording to be clearly read. Signs shall be worded in English and Spanish. The signs shall be posted at the corners and midpoints of the pond and irrigation field perimeters.

Treatment/Storage Ponds

5. Water at the surface of the ponds shall meet the following quality limits at all times:

In any grab sample:

- |                      |                                |
|----------------------|--------------------------------|
| a. Dissolved Oxygen  | 2.0 mg/l, minimum              |
| b. Dissolved Sulfide | 0.1 mg/l, maximum              |
| c. pH                | 6.0, minimum;<br>9.0, maximum. |

6. To prevent the threat of overflows, a minimum freeboard of two (2) feet shall be maintained in the ponds at all times.
7. The ponds shall be adequately protected from erosion, washout, and flooding from a rainfall event having a predicted frequency of once in 100 years.

Reclaimed Water System

8. Drip irrigation system emitters must be installed close to the ground and in such a manner to minimize the possibility that fruit will be sprayed with reclaimed water, if the emitters become plugged, broken or accidentally removed. The drip irrigation lines must be periodically inspected to ensure compliance with this provision.
9. A setback distance of at least 100 feet shall be maintained at all times between the drip irrigation area and any domestic water supply well.
10. A setback distance of at least 20 feet shall be maintained at all times between areas irrigated with reclaimed water and the line of the potable water supply main located within the proposed drip irrigation area.
11. There shall be at least a 10 foot horizontal and a one foot vertical separation between all major pipelines transporting reclaimed water and pipelines transporting domestic water, with the domestic water pipelines above the reclaimed water pipelines.

12. The downslope perimeters of the drip irrigation area shall be bermed or equipped with a tail-water collection system to prevent off-site runoff of reclaimed water.

### Reclaimed Water Use

13. The Dischargers shall assure that reclaimed water disposed to the drip irrigation field is at all times an adequately oxidized, filtered, disinfected wastewater that meets the following quality limits at all times:

In any grab sample:

- |    |                                    |                    |
|----|------------------------------------|--------------------|
| a. | Five-day Biochemical Oxygen Demand | 40.0 mg/l, maximum |
| b. | Dissolved Oxygen                   | 1.0 mg/l, minimum. |
| c. | Dissolved Sulfides                 | 0.1 mg/l, maximum  |

At a point downstream of the disinfection facilities where adequate contact with the disinfectant is assured:

- d. The median number of Total Coliform organisms shall not exceed 23 MPN/100 ml as determined from the results of the last seven days for which analyses have been completed. The number of Total Coliform organisms shall not exceed 240 MPN/100 ml in any two consecutive samples.
14. The Dischargers shall discontinue the pumping of reclaimed water to the irrigation field during any period when there is reason to believe that the limits contained in Specification (B.13) are not being met. The pumping of reclaimed water shall not be resumed until all conditions which caused the limits specified in B.13. to be violated have been corrected.
  15. The Dischargers shall manage the drip irrigation system so as to minimize wastewater ponding which could cause a mosquito breeding problem.
  16. Any grapes which come into contact with reclaimed water shall be removed from the harvestable crop which is used for wine production.
  17. Irrigation of the vineyards shall be suspended at least thirty (30) days prior to harvesting, in order to allow the soils to dry before harvesting and to prevent harvest workers from directly contacting reclaimed water.

### C. Provisions

1. The Dischargers shall comply with all sections of this Order immediately upon adoption.
2. The Dischargers shall comply with the Self-Monitoring Program as adopted by the Board and as may be amended by the Executive Officer.



3. The waste discharge requirements prescribed by this Order supersede those prescribed by the Board's Order No. 89-054 issued to Markham, Freemark Abby and The Wine Country Inn, and Order No. 82-013 which was issued to the Mont LeSalle Vineyards owned and operated by Christian Brothers Greystone Cellars. Board Orders No. 89-054 and 82-013 are hereby rescinded.
4. The Dischargers shall maintain in good working order and operate, as efficiently as possible, any facility or control system installed, or as modified, to achieve compliance with this Order.
5. All equipment, including pumps, piping, valves, storage ponds etc. which may at any time contain reclaimed water shall be adequately and clearly identified with warning signs and the Dischargers shall make all necessary provisions, in addition, to inform the public that the liquid contained is reclaimed water and is unfit for human consumption.
6. In reviewing compliance with Prohibition A.4. and Discharge Specification B.6. of this Order, the Board will take special note of the difficulties encountered in achieving compliance during entire wet seasons having a rainfall recurrence interval of greater than once in ten years.
7. In the event the Dischargers are unable to comply with any of the conditions of this Order due to:
  - a. Breakdown of wastewater transport or treatment equipment;
  - b. Accidents caused by human error or negligence; or
  - c. Other causes such as acts of nature, the Dischargers shall notify the Board by telephone as soon as the Dischargers or the Dischargers' agent(s) have knowledge of the incident. Written confirmation of this notification shall be submitted within two weeks of the telephone notification. The written notification shall include pertinent information explaining reasons for the non-compliance and shall indicate what steps were taken to correct the problem and the dates thereof, and what steps are being taken to prevent the problem from recurring.
8. The Dischargers shall permit the Board or its authorized representatives, in accordance with Section 13267(c) of the California Water Code:
  - a. Entry upon premises where a regulated facility or activity is located or conducted, or where records are kept under the conditions of this Order;
  - b. Access to and copy of, at reasonable times, any records that must be kept under the conditions of this Order;
  - c. Inspection, at reasonable times, of any facility, equipment (including monitoring and control equipment), practices, or operations regulated or required under this Order; or
  - d. To photograph, sample or monitor, at reasonable times, for the purpose of assuring compliance with this Order.

9. In the event of any change in control or ownership of land or waste discharge facilities presently owned or controlled by the Dischargers, the Dischargers shall notify the succeeding owner or operator of the existence of this Order by letter, a copy of which shall be forwarded to this Board.
10. The Dischargers shall file with the Board a Report of Waste Discharge at least 180 days before making any material change in the character, location, or volume of the reuse, except for emergency conditions in which case the Board shall be notified.
11. The Board will review this Order periodically and may revise the requirements when necessary.
12. After notice, this order may be terminated or modified for cause, including, but not limited to:
  - a. Violation of any term or condition contained in this Order;
  - b. Obtaining this Order by misrepresentation, or failure to disclose fully all relevant facts;
  - c. A change in any condition that requires either a temporary or permanent reduction or elimination of the authorized reuse; or
  - d. Endangerment to public health or environment that can only be regulated to acceptable levels by Order modification or termination.

I, Loretta K. Barsamian, Executive Officer, do hereby certify the foregoing is a full, true, and correct copy of an Order adopted by the California Regional Water Quality Control Board, San Francisco Bay Region on July 15, 1998.

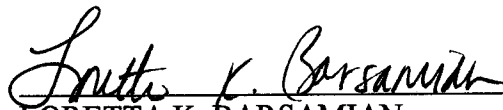
  
LORETTA K. BARSAMIAN  
Executive Officer

Attachments:  
Service Map  
Self-Monitoring Program

[Merged case: No 2139.3088 and 2139.3034B]

**AERATED LAGOON TREATMENT**

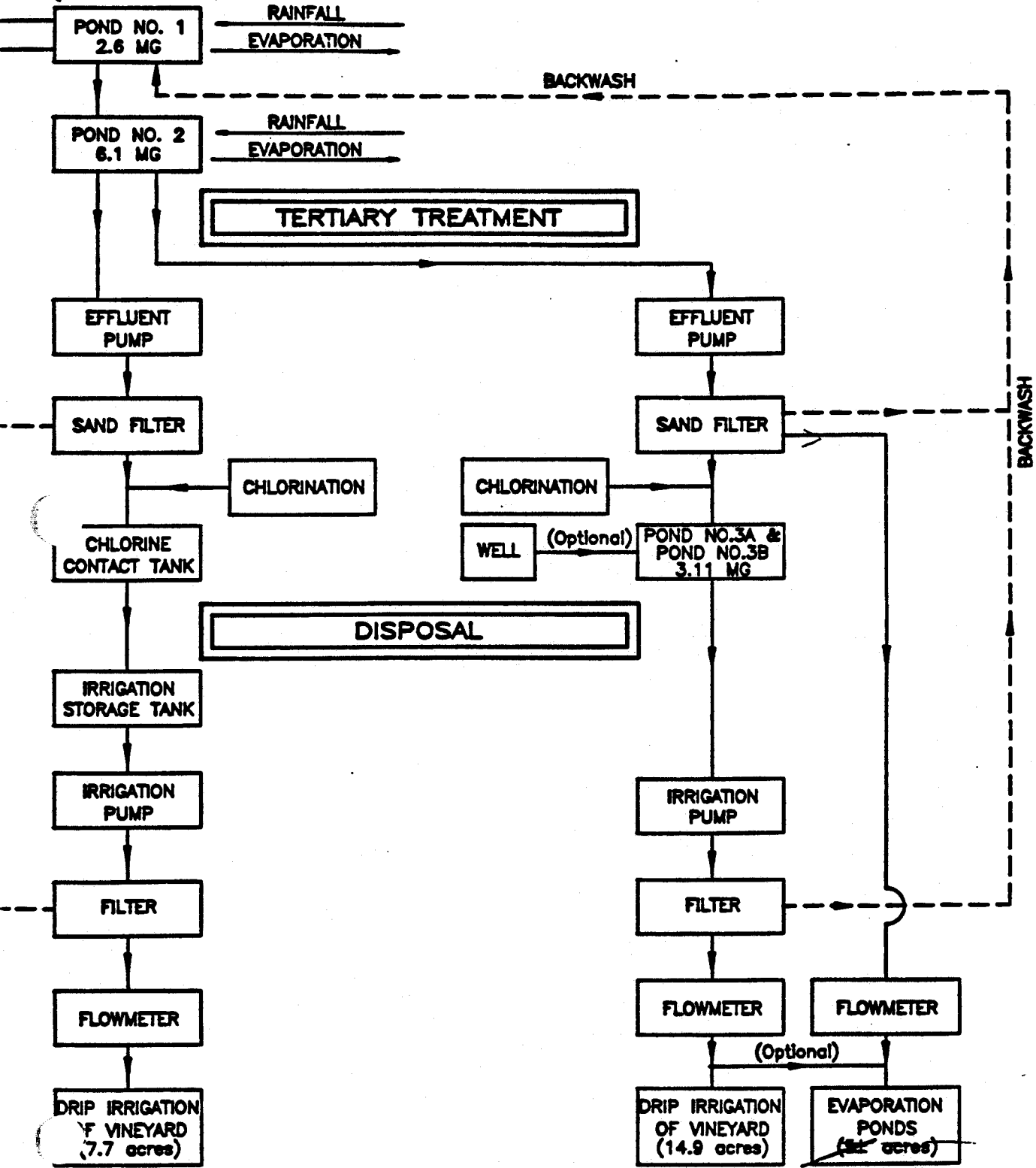

2.6 ATTACHMENT 1.

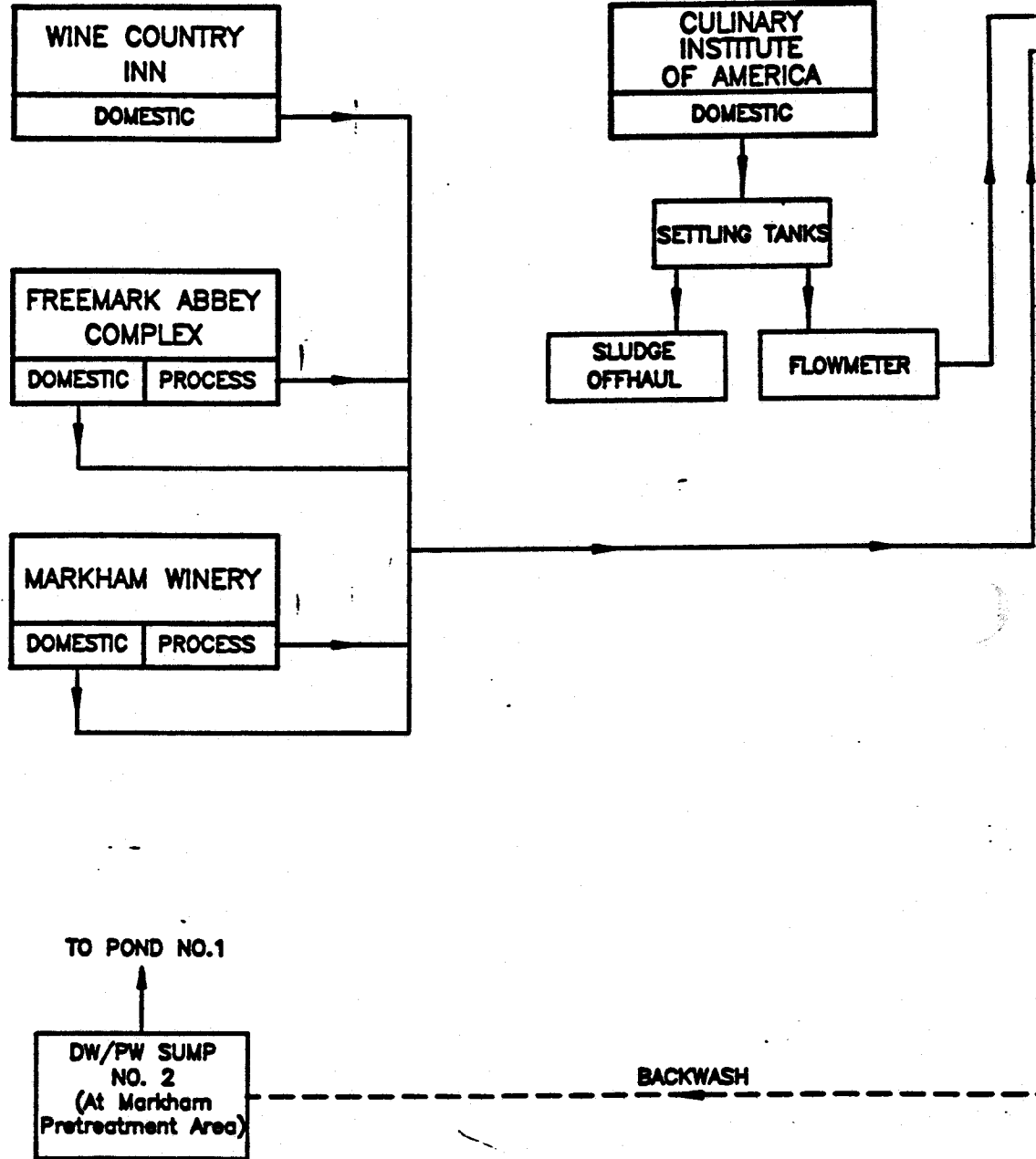

**WASTEWATER SYSTEM SCHEMATIC**

CALIFORNIA REGIONAL WATER QUALITY CONTROL BOARD  
SAN FRANCISCO BAY REGION

SELF-MONITORING PROGRAM

FOR

CULINARY INSTITUTE OF  
AMERICA - GREYSTONE CELLERS

WINE COUNTRY INN

FREEMARK ABBEY WINERY

AND

MARKHAM WINERY

IN NAPA COUNTY

ORDER NO. 98-064

CONSISTS OF

PART A

[Standard Provisions]

and

PART B

[Site Specific Provisions]

## **PART A.**

### **I. GENERAL**

Reporting responsibilities of waste dischargers are specified in Sections 13225(a), 13267(b), 13268, 13383, and 13387(b) of the California Water Code and this Regional Board's Resolution No. 73-16.

The principle purposes of a monitoring program by a waste discharger, also referred to as a self-monitoring program, are:

1. To document compliance with waste discharge requirements and prohibitions established by this Regional Board; and
2. To facilitate self-policing by the discharger in the prevention and abatement of pollution arising from waste discharge.

### **II. SAMPLING AND ANALYTICAL METHODS**

Sample collection, storage, and analyses shall be performed according to Code of Federal Regulations Title 40, Section 136 (40 CFR S136), or other methods approved and specified by the Executive Officer of this Regional Board.

Water and waste analyses shall be performed by a laboratory approved for these analyses by the State Department of Health Services (DHS), or a laboratory waived by the Executive Officer from obtaining a DHS certification for these analyses.

The director of the laboratory whose name appears on the certification, or his/her laboratory supervisor who is directly responsible for the analytical work performed shall supervise all analytical work including appropriate quality assurance / quality control procedures in his / her laboratory and shall sign all reports of such work submitted to the Regional Board.

All monitoring instruments and equipment shall be properly calibrated and maintained to ensure accuracy of measurements.

### **III. DEFINITION OF TERMS**

A. A grab sample is defined as an individual sample collected in a short period of time not exceeding 15 minutes. Grab samples represent only the condition that exists at the time the sample is collected.

B. A flow sample is defined as the accurate measurement of the flow volume over a given period of time using a properly calibrated and maintained flow measuring device. Flows calculated from properly maintained pump useage records for an accurately calibrated pump are acceptable.

A. Standard Observations

1. Pond Area

- a. For each pond, determine height of the freeboard at the lowest point of the pond perimeter levees.
- b. Evidence of seepage from the ponds (Show affected area on a sketch, and estimate volume or flow rate).
- c. Odor from ponds: If present, indicate apparent source, characterization, direction of travel, and any public use areas or offsite facilities affected by the odors.
- d. Estimated number of waterfowl and other water-associated birds in the pond area.
- e. Warning signs properly posted to inform public that pond contains wastewater which is not safe for drinking or contact.

2. Vineyard Drip Irrigation Site

- a. Evidence of runoff of reclaimed water from the site (Show affected area on a sketch, and estimate volume).
- b. Odor from Irrigation site: If present, indicate apparent source, characterization, direction of travel, and any public use areas or offsite facilities affected by the odors<sup>1</sup>.
- c. Evidence of ponding of reclaimed water, and/or evidence of mosquitoes breeding within the irrigation area due to ponded water.
- d. Warning signs properly posted to inform public that irrigation water is reclaimed water which is not safe for drinking or contact.
- e. Evidence of leaks or breaks in the drip irrigation system pipelines or tubing.
- f. Evidence of plugged, broken or otherwise faulty drip irrigation system emitters.

---

<sup>1</sup> \* Note: Odors are not considered violations when confined within the dischargers' property, and the potential for transmission of odors to public use areas or offsite facilities is minimal.

## **PART B.**

### **I. DESCRIPTION OF SAMPLING AND OBSERVATION STATIONS**

#### **A. POND INFLUENT**

<u>Station</u>	<u>Description</u>
A-1	At a point in the Wine Country Inn wastewater collection system at which all waste tributary to the ponds from this facility is present.
A-2	At a point in the Freemark Abbey Winery waste-water collection system at which all waste tributary to the ponds from this facility is present.
A-3	At a point in the Markham Winery wastewater collection system at which all waste tributary to the ponds from this facility is present.
A-4	A point in the Culinary Institute-Greystone Cellars wastewater collection system at which all waste tributary to the ponds from this facility is present.

#### **B. POND EFFLUENT**

<u>Station</u>	<u>Description</u>
E-1	At a point in the pond effluent prior to being applied to irrigation site (May be same as E-1-D).
E-1-D	At a point in the effluent from the disinfection facilities at which adequate contact with the disinfectant is assured.

#### **C. POND WATERS**

<u>Station</u>	<u>Description</u>
1P-1	At points in Pond 1 (first aeration)
2P-1	At points in Pond 2 (second aeration)
3P-1	At points in Pond 3 (Storage)



## D. OBSERVATION STATIONS

### Station Description

- 1L-1 Pond Levees - at the midpoints of the perimeter through levee around the ponds.
- I-1 Drip Irrigation Site - at the midpoints of the through irrigation site perimeter, and at two points in I-6 the middle of the irrigation area.

## II. SCHEDULE OF SAMPLING, MEASUREMENTS, AND ANALYSIS

A. The Dischargers are required to perform observations, sampling, measurements and analyses according to the schedule given in Table 1, below.

B. The Dischargers shall conduct a complete inspection of all drip irrigation lines and emitters at least once each year, during the vineyard's dormant season. A report of the findings of this inspection, including a description of any repairs or modifications made to the drip irrigation system, shall be submitted to the Board by April 15th.

## III. REPORTS TO BE FILED WITH THE REGIONAL BOARD

### A. Self-Monitoring Reports

Written reports shall be filed regularly for each calendar quarter (ending March, June, September and December). Reports shall be submitted to this Regional Board's office no later than the fifteenth day of the month following the end of each quarter. The reports shall consist of the following:

#### 1. Letter of Transmittal

A letter transmitting the self-monitoring reports should accompany each report. Such a letter shall include a discussion of requirement violations found during the reporting period, and actions taken or planned for correcting noted violations, such as operation or facility modifications. If the Discharger has previously submitted a report describing corrective actions and/or a time schedule for implementing the corrective actions, reference to the previous correspondence will be satisfactory.

The transmittal letter shall contain a statement by the Discharger, or the Discharger's authorized agent, under penalty of perjury, that to the best of the signer's knowledge the report is true, accurate and complete.

#### 2. Results of Analyses and Observations

- a. Tabulations of the results from all required analyses specified in Table 1 by date, time, type of sample, and sample station.
- b. Completed Pond Observation and Reclaimed Water Use Report forms (Attached) or reports with equivalent information.

B. Report of Permit Violation

In the event the Discharger violates, or threatens to violate the conditions of the waste discharge requirements and prohibitions due to:

- a. Maintenance work, power failure, or breakdown of wastewater transport or treatment equipment;
- b. Accidents caused by human error or negligence; or
- c. Other causes such as acts of nature, the Discharger shall notify the Regional Board office by telephone as soon as the Discharger or the Discharger's agents have knowledge of the incident. Written confirmation of this notification shall be submitted within two weeks of the telephone notification. The written notification shall include pertinent information explaining reasons for the non-compliance and shall indicate what steps were taken to correct the problem and the dates thereof, and what steps are being taken to prevent the problem from recurring.

I, Loretta K. Barsamian, Executive Officer, hereby certify that the foregoing Self-Monitoring Program:

1. Has been developed in accordance with the procedure set forth in the Regional Board's Resolution No. 73-16 in order to obtain data and document compliance with waste discharge requirements established in Regional Board Order No.98-064.
2. Is effective on the date shown below.
3. May be revised at any time after the effective date by the Executive Officer.

  
LORETTA K. BARSAMIAN  
Executive Officer

Effective Date July 15, 1998

Attachments

1. Pond Observation Report Form
2. Reclaimed Water Use Report Form

[File No. 2139.3088]

[TRG/trg C:/1main/napa/ciawdr/ciasmp]

**Table 1.  
Schedule for Sampling, Measurements and Analyses**

P  
A  
R  
A  
M  
E  
T  
E  
R  
S

Sampling Stations / Parameter	All A Stations	Pond Effluent E-1	Post-Disinfection PD-1	P-1 and P-2	All L	All I
Type of Sample	flow rate	grab	grab	grab	observations	observations
Total flow	monthly	monthly				
pH (units)				monthly		
Dissolved Oxygen (mg/l)				monthly		
Biological Oxygen Demand (BOD)		monthly				
Dissolved Sulfides		monthly when D.O. is below 2mg/l		monthly when D.O. is below 2mg/l		
Total Coliform (MPN/100ml)			three per week on non-consecutive days			
Standard Observations					Every Two Weeks	Every Two Weeks during irrigation operations

**POND OBSERVATION REPORT**

(WINE COUNTRY INN, FREEMARK ABBEY WINERY, AND MARKHAM WINERY)  
AND THE CULINARY INSTITUTE

1. Reporting Period (Month/Year): \_\_\_\_\_
2. Monthly Flow to Ponds, from indicated facility (gallons):  
  - a. Wine Country Inn (A-1) \_\_\_\_\_
  - b. Freemark Abbey Winery (A-2) \_\_\_\_\_
  - c. Markham Winery (A-3) \_\_\_\_\_
  - d. Total \_\_\_\_\_

3. Required observations:  
(Provide required information, and indicate 'yes' or 'no' where applicable, according to observed conditions.)

Inspection Date and Time:								
Freeboard (feet):								
a) Pond 1 (Aeration Pond)								
b) Pond 2 (Larger Pond)								
Observation Stations:	L-1	L-2	L-3	L-4	L-1	L-2	L-3	L-4
Evidence of seepage from pond								
Nuisance Odors from Pond								
Estimated number of water-fowl in pond area								
Warning Signs Improperly Posted								
Public Contact with Pond Water								

If any of the above yes/no observations were yes, indicating a violation of waste discharge requirements, a written report containing the following information shall be submitted:

- a. Time when violation was observed.
- b. Show location of violation on a sketch of the site.
- c. Explain cause and extent of violation.
- d. Describe corrective action taken and the dates compliance was achieved and irrigation was resumed.

4. I certify that the information in this report, to the best of my knowledge, is true and correct.

\_\_\_\_\_  
Signature of User Supervisor

\_\_\_\_\_  
Date

MARKHAM VINEYARDS

Project No. 2013171

March 27, 2014

**SUMMIT ENGINEERING, INC.**

Wastewater Feasibility Study

BY: CN CHK: RR

---

**SUMMIT** 

**SUMMIT ENGINEERING, INC.**

463 Aviation Blvd., Suite 200

Santa Rosa, CA 95403

707 527-0775

[www.summit-sr.com](http://www.summit-sr.com)