

~~2010~~2011

Adopted April 27, 1991

Revised May 10, 1977

Revised August 18, 1987

Revised June 5, 1990

{Ordinance 854}

Revised August 2, 1999

{Ordinance 1160}

Revised August 31, 2004

{Resolution 04-150}

Revised November 21, 2006

{Resolution 06-198}

[Revised XXXXXXXX xx, 2011](#)

[{Resolution XX-XXX}](#)



Style Definition: TOC 1

Formatted Table

Formatted: Line spacing: single

A Tradition of Stewardship
A Commitment to Service

NAPA COUNTY ROAD & STREET STANDARDS

Department of Public Works * 1195 Third Street * Room 201 * Napa, California 94559

Phone: (707) 253-4351 * Fax: (707) 253-4627 * www.countyofnapa.org

[Page | 1](#)

[Page | 1](#)

Table of Contents

ITEM	PAGE #
<u>1. OBJECTIVES</u>	<u>75</u>
<u>2. SCOPE OF STANDARDS</u>	<u>86</u>
<u>3. EXCEPTIONS TO STANDARDS.....</u>	<u>86</u>
<u>4. DEFINITIONS</u>	<u>108</u>
<u>5. HILL AREAS AND FLATLAND AREAS</u>	<u>119</u>
<u>6. HIGH DENSITY DEVELOPMENTS</u>	<u>129</u>
<u>7. LOW DENSITY DEVELOPMENTS</u>	<u>129</u>
<u>8. PRIVATE ROAD DEVELOPMENTS</u>	<u>1240</u>
<u>9. PARKING REQUIREMENTS</u>	<u>1240</u>
<u>10. PEDESTRIAN, BICYCLE AND/OR BUS FACILITIES</u>	<u>1310</u>
<u>11. CURB, GUTTER AND SIDEWALK</u>	<u>1311</u>
<u>12. RESIDENTIAL DRIVEWAYS.....</u>	<u>1311</u>
<u>13. COMMERCIAL INDUSTRIAL AND NON-RESIDENTIAL DRIVEWAYS</u>	<u>1311</u>
<u>14. STREET AND ROAD CLASSIFICATIONS.....</u>	<u>1411</u>
<u>Major Roads.....</u>	<u>1411</u>
<u>Minor Roads</u>	<u>1412</u>
<u>Other Roads.....</u>	<u>1512</u>
<u>15. DESIGN CRITERIA</u>	<u>1613</u>
<u>Design Criteria Chart.....</u>	<u>2017</u>
<u>16. INDUSTRIAL AND COMMERCIAL DEVELOPMENT.....</u>	<u>2118</u>
<u>17. TRAFFIC CONTROL DEVICES.....</u>	<u>2118</u>
<u>Left Turn Lane Warrant Graph</u>	<u>2320</u>
<u>18. TYPICAL CROSS SECTIONS.....</u>	<u>2421</u>
<u>C-1 Arterial Cross Sections.....</u>	<u>2822</u>
<u>C-2 Arterial Cross Sections Without Parking</u>	<u>2923</u>
<u>C-3 Collector Cross Sections</u>	<u>3024</u>
<u>C-4 General Minor Cross Sections</u>	<u>3125</u>
<u>C-5 Non-Continuing Minor, Loop Road and Cul-De-Sac</u>	<u>3226</u>
<u>C-6 One Way Loop Cross Sections</u>	<u>3327</u>
<u>C-7 Common Drive Cross Sections</u>	<u>3428</u>
<u>C-8 Industrial Collector Standards.....</u>	<u>3529</u>
<u>C-9 Industrial Minor.....</u>	<u>3630</u>
<u>C-10 Residential Driveway or Agricultural Special Purpose Road</u>	<u>3731</u>
<u>C-11 Standard Driveway Turn Out.....</u>	<u>3832</u>
<u>C-12 Standard Bulb Turnout.....</u>	<u>3933</u>
<u>C-13 Standard Hammerhead Turnaround.....</u>	<u>4034</u>

	C-14 Residential Driveway Shunt Turnaround	4135
19.	DETERMINATION OF TRAFFIC VOLUMES	4336
20.	DETERMINATION OF STRUCTURAL SECTION.....	4336
	Traffic Index Chart	4537
	Structural Section Thickness Chart.....	4638
21.	GRADING REQUIREMENTS AND SOILS INVESTIGATIONS (FOR ROADS).....	4739
22.	DRAINAGE REQUIREMENTS.....	4739
	Design Discharge For Small Basins	5143
	Watershed Types and Factors	5244
	Runoff Coefficient for Developed Areas.....	5445
	Precipitation Chart – Lower County	5546
	Precipitation Chart – Upper County	5647
	Mean Annual Precipitation vs. 60 Minute Rainfall.....	5748
	Intensity – Duration Chart	5849
	Critical Slopes and Capacities of Round Pipes Table	5950
	Nomograph Chart.....	6051
	Unlined Channel Velocity	6152
23.	PLANNED UNIT DEVELOPMENT AND OTHER TYPES.....	6253
24.	ASSESSMENT DISTRICTS	6253
25.	PARCEL MAP IMPROVEMENTS - RESIDENTIAL DEVELOPMENT	6354
26.	PARCEL MAP IMPROVEMENTS - COMMERCIAL AND INDUSTRIAL DEVELOPMENT.....	6455
27.	SPECIFICATIONS.....	6455
	Road and Streets	6455
	Utilities.....	6556
	Drainage	6657
	Monuments	6657
	Permits.....	6758
	STANDARD DETAILS	6959
	P-1 On Lot Parking Detail	7060
	P-2 Driveway Connection to Arterial Roads – Rural Roads.....	7161
	P-3 Residential Driveway and Adjoining Sidewalk	7262
	P-4 Commercial & Industrial Driveway & Adjoining Sidewalk.....	7363
	P-5 Standard Vertical Curb & Gutter.....	7464
	P-6 Mountable Curb.....	7565
	P-7 P.C.C. Cross Gutter	7666
	P-8 Standard Asphalt Dike.....	7767
	P-9 Typical Dike Installation	7868
	P-10 Trench Backfill Typical Section.....	7969
	P-11 Drainage Outlet.....	8070
	D-1 Storm Drain Inlet Type “A”.....	8171
	D-2 Storm Drain Inlet Type “B”.....	8272

D-3	Storm Drain Inlet Type "C"	8373
D-4	Standard Barricade.....	8474
D-5	Driveway Setback.....	8575
D-6	Standard Street Sign	8676
D-6a	Standard Street Signs, Type 'A' and Type 'B'.....	8777
	Subdivision Street Monuments Accuracy.....	8878
D-7	Survey Monument	8979
D-8	Off Street Parking.....	9080
D-9	Handicap Symbol.....	9181
D-10	Wheel Chair Ramp	9282
D-11	Gated Entrance	9383

1.	OBJECTIVES.....	5
2.	SCOPE OF STANDARDS	6
3.	EXCEPTIONS TO STANDARDS.....	6
4.	HILL AREAS AND FLATLAND AREAS	8
5.	HIGH DENSITY DEVELOPMENTS	8
6.	LOW DENSITY DEVELOPMENTS	8
7.	PRIVATE ROAD DEVELOPMENTS	9
8.	PARKING REQUIREMENTS	9
9.	PEDESTRIAN, BICYCLE AND/OR BUS FACILITIES	9
10.	CURB, GUTTER AND SIDEWALK.....	10
11.	RESIDENTIAL DRIVEWAYS.....	10
12.	COMMERCIAL INDUSTRIAL AND NON-RESIDENTIAL DRIVEWAYS.....	10
13.	STREET AND ROAD CLASSIFICATIONS.....	10
	Major Roads.....	10
	Minor Roads.....	11
	Other Roads.....	11
14.	DESIGN CRITERIA	12
	Design Criteria Chart.....	15
15.	INDUSTRIAL AND COMMERCIAL DEVELOPMENT.....	16
16.	TRAFFIC CONTROL DEVICES	16
	Left Turn Lane Warrant Graph	18
17.	TYPICAL CROSS SECTIONS.....	19

<u>Arterial Cross Sections</u>	20
<u>Collector Cross Sections</u>	21
<u>General Minor Cross Sections</u>	22
<u>Non-Continuing Minor, Loop Road and Cul-De-Sac</u>	23
<u>One-Way Loop Cross Sections</u>	24
<u>Common Drive Cross Sections</u>	25
<u>Industrial Collector Standards</u>	26
<u>Industrial Minor</u>	27
<u>Residential Driveway and Agricultural Special Purpose Road</u>	28
<u>18. DETERMINATION OF TRAFFIC VOLUMES</u>	29
<u>19. DETERMINATION OF STRUCTURAL SECTION</u>	29
<u>Traffic Index Chart</u>	30
<u>Structural Section Thickness Chart</u>	31
<u>20. GRADING REQUIREMENTS AND SOILS INVESTIGATIONS (FOR ROADS)</u>	32
<u>21. DRAINAGE REQUIREMENTS</u>	32
<u>Design Discharge Chart</u>	36
<u>Watershed Types and Factors Chart</u>	37
<u>Runoff Coefficient Chart</u>	38
<u>Precipitation Chart</u>	39
<u>Mean Annual Precipitation Chart</u>	40
<u>Intensity – Duration Chart</u>	41
<u>Slopes and Capacities Chart</u>	42
<u>Nomograph Chart</u>	43
<u>Unlined Channel Velocity Chart</u>	44
<u>22. PLANNED UNIT DEVELOPMENT AND OTHER TYPES</u>	45
<u>23. ASSESSMENT DISTRICTS</u>	45
<u>24. PARCEL MAP IMPROVEMENTS – RESIDENTIAL DEVELOPMENT</u>	46
<u>25. PARCEL MAP IMPROVEMENTS – COMMERCIAL AND INDUSTRIAL DEVELOPMENT</u>	47
<u>26. SPECIFICATIONS</u>	47
<u>27. Permits</u>	50
<u>STANDARD DETAILS</u>	51
<u>P-1 On Lot Parking Detail</u>	52
<u>P-2 Driveway Connection to Arterial Roads – Rural Roads</u>	53
<u>P-3 Residential Driveway and Adjoining Sidewalk</u>	54
<u>P-4 Commercial & Industrial Driveway & Adjoining Sidewalk</u>	55
<u>P-5 Standard Vertical Curb & Gutter</u>	56
<u>P-6 Mountable Curb</u>	57
<u>P-7 P-C-C Cross Gutter</u>	58
<u>P-8 Standard Asphalt Dike</u>	59
<u>P-9 Typical Dike Installation</u>	60
<u>P-10 Trench Backfill Typical Section</u>	61

<u>P-11</u>	<u>Drainage Outlet</u>	<u>62</u>
<u>D-1</u>	<u>Storm Drain Inlet Type "A"</u>	<u>63</u>
<u>D-2</u>	<u>Storm Drain Inlet Type "B"</u>	<u>64</u>
<u>D-3</u>	<u>Storm Drain Inlet Type "C"</u>	<u>65</u>
<u>D-4</u>	<u>Standard Barricade</u>	<u>66</u>
<u>D-5</u>	<u>Driveway Setback</u>	<u>67</u>
<u>D-6</u>	<u>Standard Street Sign</u>	<u>68</u>
<u>D-6a</u>	<u>Standard Street Signs, Type 'A' and Type 'B'</u>	<u>69</u>
	<u>Subdivision Street Monuments Accuracy</u>	<u>70</u>
<u>D-7</u>	<u>Survey Monument</u>	<u>71</u>
<u>D-8</u>	<u>Off Street Parking</u>	<u>72</u>
<u>D-9</u>	<u>Handicap Symbol</u>	<u>73</u>
<u>D-10</u>	<u>Wheel Chair Ramp</u>	<u>74</u>
<u>D-11</u>	<u>Gated Entrance</u>	<u>75</u>
<u>D-12</u>	<u>Standard Gate</u>	<u>76</u>

1. OBJECTIVES

The following material was originally prepared through the cooperation of the Road Standards Advisory Committee of 1970. Since then, updates have been incorporated to reflect changes in accepted health and safety practices and to comply with changes in County Ordinances and State and Federal Law. These standards attempt to meet the related interests of several other agencies the Resource Conservation District, [California Department of Forestry](#), [Cal Fire](#), Federal Emergency Management Agency, County Conservation, Development and Planning Department, and the California Department of Fish and Game. The objectives of these Standards are summarized below:

- a. To provide reasonable standards ~~that relate~~[that relates](#) to terrain and parcel size.
- b. ~~To~~[Strive to](#) preserve the natural landscape and desirable aesthetic features.
- c. To encourage the location of roads to minimize disturbance or impacts on wetlands, critical native plant communities, or other environmentally sensitive areas.
- d. To minimize diversion and concentration of storm runoff, including selection of appropriate discharge locations, outlet dispersion appurtenances and selection of practices that maximize soil infiltration.
- e. To encourage use of native grasses and other native plant materials for erosion control and habitat enhancement.
- f. To minimize alteration of streams and ephemeral drainage at discharge outfalls, utilizing "bio-technical" stream stabilization techniques and preservation of natural stream morphological conditions.
- g. To identify "impacted" runoff basins where special design considerations may be necessary to minimize downstream flooding and other impacts to neighboring properties.
- h. To provide adequate safety and service.
- i. To provide low maintenance cost road facilities.
- j. To produce standards compatible with City Requirements within areas of influence.

[These standards that were developed and revised over the years represent an effort to meet all of the objectives noted above while striving to maintain the preservation of the health, safety and welfare of the public. The 2011 revisions are intended to provide clarification and flexibility to the current design standards in order to facilitate the balance of conforming to local, state and federal regulations, recognizing current general engineering and construction practices, and accounting for unique project elements. The standards developed represent an effort to meet all of the above objectives, and obviously, compromises have been made in specific areas to achieve the desired end result. The 1999 revision is](#)

Formatted: Font: Palatino Linotype, 11.5 pt

~~intended to bring the standards into conformance with California Code of Regulations, Title 14, Section 1270-1274, and the County Fire Protection Standards.~~

All that use these standards are encouraged to become familiar with all of the codes, rules, regulations and guidance documents available. These would include, for example, such items as the Conservation Regulations, Floodplain Ordinance, Grading Ordinance, Policies, Practices and County Code Sections Administered by the Department of Environmental Management, County Fire Code, Policies and Procedures of Fish and Game, and the Soil Conservation Service's Best Management Practices for the Napa Valley. Roadway design guidance can be found in the AASHTO's "A Policy on Geometric Design of Highways and Streets" and the Caltrans "Highway Design Manual" and "Standard Specifications". Where these Napa County Roads and Streets Standards refer to the Caltrans Specifications or the Caltrans Standard Specifications, the reference shall mean the current edition of the Caltrans Standard Specifications.

2. SCOPE OF STANDARDS

These standards are not applicable retroactively to existing roads, streets and private lanes or facilities. These standards shall apply as appropriate to all construction within the unincorporated portion of Napa County beginning on the date they are adopted by the County Board of Supervisors. Activities which will trigger application are included but not limited to:

- (a) Clearance for a building permit for new construction, or substantial improvement to an existing structure where substantial improvement is determined when accumulated construction costs of greater than 50% of the retail value of the structure occur within a 5 year period,
- (b) Recommendations for a use permit,
- (c) Road construction, including construction of a road that does not currently exist, or extension of an existing road,
- (d) New subdivisions created by Parcel Map or Final Map,
- (e) Conditional certificates of compliance.

3. EXCEPTIONS TO STANDARDS

A) A property owner or leaseholder of a site may make a written request to the Director of Public Works for an exception to the Napa County Road and Street Standards. The request shall state the specific section(s) for which an exception is requested, material facts supporting the contention of the applicant, the details of the exception or mitigating measure proposed, a map showing the proposed location and siting of the exception or

mitigation measures, and shall be accompanied by that fee established by resolution of the Board of Supervisors.

B) An application for an exception from these Standards submitted in connection with a building permit clearance for a single family residence shall be decided by the Zoning Administrator after the appropriate environmental review has been completed by the Conservation, Development and Planning Department. An application for an exception from these Standards submitted in connection with a use permit, variance, subdivision map or other discretionary permit shall be heard and decided by the Planning Commission (or whoever is the approving body) at the same time as the use permit, zoning variance, subdivision map or other discretionary permit.

C) An exception to these Standards when properly submitted, reviewed, and approved by the Director, the Planning Commission or other approving body, is intended to serve as an alternate method by which adherence to these Standards may be achieved at the same time as the County assures compliance with its goal to protect and ensure the preservation of the unique features of the natural environment. It also intended to ensure compliance with the SRA Fire Safe Regulations (14 CCR 1270-1274).

Formatted: Font: 11.5 pt

D) An exception to these Standards may be allowed as provided if one or more of the following findings can be made and the findings in subsection (E) can also be made:

- 1) The exception will preserve unique features of the natural environment which includes, but is not limited to, natural water courses, steep slopes, geological features, heritage oak trees, or other trees of least 6" dbh and found by the decision-maker to be of significantly importance, but does not include man made environmental features such as vineyards, rock walls, ornamental or decorative landscaping, fences or the like;
- 2) The exception is necessary to accommodate physical site limitations such as grade differentials; and/or
- 3) The exception is necessary to accommodate other limiting factors such as recorded historical sites or legal constraints.

E) The Zoning Administrator, Planning Commission or other approving body shall not grant an exception unless it finds that grant of the exception, as conditioned by the Zoning Administrator, the Planning Commission or other approving body, provides the same overall practical effect as these Standards towards providing defensible space, and consideration

towards life, safety and public welfare. Monetary hardship shall not be considered as a basis for an exception.

F) The Fire Department shall recommend to the Zoning Administrator, the Planning Commission or other approving body that certain conditions (as determined necessary by the Fire Department) be imposed on the project to achieve the same overall practical effect as these Standards towards providing defensible space, consideration of life, safety and public welfare and not compromising civilian access or Fire Department egress. Such conditions may include, but are not limited to, installation of built-in fire protection systems, limited marketing events or visitors to the site, and improved defensible space for structures and roads.

G) Notwithstanding the above, a request for an exception to these Standards for a public road or public drainage facility shall be decided by the Director of Public Works and determined on a case-by-case basis.

H) The grant or denial of an exception shall be considered part of the decision of the underlying permit and appeals shall be processed in the same manner as provided by the Napa County Code for appeals of the underlying permit.

Definition of "Inspection Authority."

For purposes of processing of an exception as described in these Standards, "inspection authority" as used in the SRA Fire Safe Regulations shall mean the Zoning Administrator for an exception from these Standards submitted in connection with a building permit clearance for a single family residence and the Planning Commission or other approving body for an exception from these Standards submitted in connection with a use permit, zoning variance, subdivision map or other discretionary permit.

4. DEFINITIONS

<u>'AB'</u>	<u>Aggregate Base – a gravel mixture meeting material and compaction requirements as defined in Section 26 of the Caltrans Standard Specs.</u>
<u>'Caltrans'</u>	<u>The State of California, Department of Transportation.</u>
<u>'CDPD'</u>	<u>Conservation, Development and Planning Department</u>
<u>'Caltrans Standard Specs'</u>	<u>State of California, Department of Transportation, Division of Highways, Standard Specifications in latest edition.</u>

Formatted: Heading 1, Indent: First line: 0", Adjust space between Latin and Asian text, Adjust space between Asian text and numbers

Formatted: Indent: Left: 0.25", Hanging: 1.75", Adjust space between Latin and Asian text, Adjust space between Asian text and numbers, Tab stops: 2", Left

<u>'County Engineer'</u>	<u>The Director of Public Work or his/her designee.</u>
<u>'Drivable Shoulder'</u>	<u>The area adjoining the Travel Lane that is designed to support H20-44 loading and shall be a minimum of 5-inches of aggregate base material.</u>
<u>'Drivable Swale'</u>	<u>A shallow sloped drainage way that runs parallel to the travel lane of a driveway and is surfaced with non-erodible material desined to support H-20 loading criteria at all times even during periods of saturation.</u>
<u>'Driveway'</u>	<u>A privately owned and maintained access road connecting a parcel to a public roadway.</u>
<u>'HMA'</u>	<u>Hot Mix Asphalt meeting material and compaction requirements as defined in Section 39 of the Caltrans Standard Specs.</u>
<u>'Inter-visible Turnout'</u>	<u>Turn outs that are located the required distance apart where a driver in one vehicle in a turn out can visibly identify a vehicle in the other turn out and vice versa.</u>
<u>'Paved'</u>	<u>A road surface meeting either the minimum structural section of 2" HMA over 5" Class 2 AB or as designed and approved by the County Engineer with both meeting Caltrans Standard Specs for material type and compaction.</u>
<u>'Roadway'</u>	<u>A road that is a minimum of 20 feet in width dedicated for public use serving an area.</u>
<u>'Travel Lane'</u>	<u>The surfaced portion of the travel way that is designed to carry the daily traffic volume.</u>
<u>'Travel Way'</u>	<u>The combination of Travel Lane and Drivable Shoulder that shall constitute the full width area a vehicle can safely traverse.</u>

4.5.HILL AREAS AND FLATLAND AREAS

For the application of these standards, the County has been divided into two categories; hill areas, which are comprised of lands generally having an average slope of 10% or more, and flatland areas, generally having lesser slopes. Type I Standards are applicable to flatlands and Type II Standards apply to hill areas. The two categories are delineated on a set of Topographical Maps on file in the office of the Department of Public Works at 1195 Third Street, Napa. The maps are intended to provide the Developer and Engineer with the information needed to determine the proper road classification. Due to the scale of maps, the boundaries between hill areas and flatlands are subject to adjustment for specific

developments if, in the opinion of the County Engineer, such adjustment is consistent with the objectives of these standards.

5-6.HIGH DENSITY DEVELOPMENTS

Developments, which have an average lot size less than $\frac{3}{4}$ acre per dwelling unit and/or in which 90% of the lots have frontages less than 115' feet will be classified as "high density" regardless of the location within the County.

6-7.LOW DENSITY DEVELOPMENTS

Developments, which have an average lot size greater than ~~$\frac{3}{4}$~~ acre per dwelling unit and/or in which 90% of the lots have frontages greater than 115' feet will be classified as "low density". Developments with an average parcel size of 10 acres or more will qualify for the use of Type II Standards even in flatland areas.

7-8.PRIVATE ROAD DEVELOPMENTS

Private road developments may be allowed upon specific approval of the County, and are subject to the same improvement requirements as public road requirements. However, the roads will not be maintained by the County. Developers are generally required to offer to dedicate roadways but the County will not accept the roads that are to remain private.

8-9.PARKING REQUIREMENTS

- a) "Full street parking, consisting of two parallel parking lanes, is required adjacent to lots for all high-density developments, whether in hill areas or flatlands.
- b) Parking for all other developments shall consist of at least two street spaces per lot or four spaces on the lot (see detail P-1) in addition to the garage and carport, or an equivalent combination thereof such as two on lot and one on street parking spaces in addition to garage and carport. Street parking may be provided by "bays", parallel street parking on one side only, or an acceptable alternate as long as the distance from the parking bay to the lot served does not exceed 150' feet. Minimum building setbacks of 60' feet from the right of way line will satisfy parking requirements in low-density developments. Set back requirements will be shown on a document to be recorded concurrently with the Final Subdivision Map or Parcel Map. All streets without on-street parking provisions shall be posted with "No Parking" signs or other suitable regulatory devices.

9-10. PEDESTRIAN, BICYCLE AND/OR BUS FACILITIES

- a) Fully improved Portland cement concrete sidewalks will be provided on both sides of all roads in high density developments in accordance with the typical cross sections.
- b) In low density developments, an improved walkway will be provided on both sides of urban arterial and collector roads.
- c) Where development is located on an existing bus route, The Napa County Transportation Planning Agency shall be consulted for recommended improvements based on the Transit Improvement Standards Handbook.

Additional pedestrian and/or bicycle facilities may be required if there is a potential for concentrated pedestrian and/or bicycle traffic in the opinion of the County Engineer.

10-11. CURB, GUTTER AND SIDEWALK

Vertical curb and gutter with monolithic sidewalk may be used if all driveway locations are predetermined and constructed at the time of the subdivision development.

If driveway locations are not provided with the road construction, mountable curb will be used and any required sidewalks will be located with one side contiguous with the right of way line. Refer to the typical sections and standard details. Mountable curb will not be used on steep grades where it would be a hazard to the public, as determined by the County Engineer.

11-12. RESIDENTIAL DRIVEWAYS

As part of the construction of a new dwelling unit(s) ~~or substantial improvements/expansion~~ to an existing dwelling unit(s) or addition of any accessory structure requiring a building permit, the property owner shall ~~provide a minimum 10 foot wide driveway with an earth shoulder of 4 feet in total and proper turnouts~~ meet the driveway provisions as defined in these standards applicable to the proposed improvement and site specific conditions, from the publicly maintained road to the new or improved structure. Refer to Section 15 for specific design criteria. See detail C-10 for rural driveways, and detail D-5 and P-3 for urban driveways.

12-13. COMMERCIAL INDUSTRIAL AND NON-RESIDENTIAL DRIVEWAYS

As part of a new commercial, industrial, and non-residential (excluding Group U as defined by the California Building Code) use or improvements to an existing commercial, industrial or non-residential building requiring a building permit, property owner shall provide a min. 18' wide driveway from the publicly maintained road to the improved

structure. See detail C-7, Common Drive, for cross-section information. See detail D-5 and P-4 for urban driveways and detail P-2 for rural driveways.

13-14. STREET AND ROAD CLASSIFICATIONS

The following list of street and road types is intended to be representative of typical subdivision development and does not include all roads and streets that will be encountered. Geometric requirements relative to highways, expressways, major roads, access included in these Standards may be applied to a specific case and required or allowed. Regarding the requirements relative to roads serving commercial and industrial areas see the appropriate subsequent sections. All roads are required to be paved with the exception of agricultural special purpose roads and rural driveways which shall be surfaced per detail C-10. Pavement section shall be determined by the designed Traffic Index. Minimum structural section shall be 2 inches of asphalt concrete/HMA over 5 inches of aggregate base Class 2 AB in accordance with Section 27 of these standards.

MAJOR ROADS

<u>Street or Road</u>	<u>Definition</u>
a) Arterial	Connects collectors to highways, and other major arterials; functions primarily to carry traffic, estimated volume 5000 vehicles per day or more. May be two or more lanes with or without median strips and controlled access.
b) Collector	Generally collects traffic from lesser roads and also serves as access to adjacent land. Traffic volume of 1000 to 5000 vehicles per day.

MINOR ROADS

c) General Minor	Serves primarily as access to adjacent land, carries up to 1000 vehicles per day.
d) Loop Road and Non Continuing Minor	Serves abutting property; carries up to 250 vehicles per day.
e) Cul-de-Sac *	Serves as an access road to abutting property; traffic volume up to 250 vehicles per day.

- f) One Way Loop Roads Special purpose roads depending on site circumstances; maximum length ¼ mile in flatland areas and ½ mile in hill areas; traffic volume up to 150 vehicles per day.
- g) Common Drive Serves as residential access to for two (2), three, four, five or to six (6) parcels based on ultimate development and as access for commercial, industrial and non-residential uses. Developments that have a legal and practical potential for re-division into more than 6 parcels will not qualify for use of common drives.
- h) Rural Residential Driveway Serves as the minimum access to a maximum of two buildings, with no more than three dwelling units on a single parcel one residential parcel meeting CDPD development standards, and any number of accessory buildings.

OTHER ROADS

- i) Agricultural Special Purpose Road related Serves agricultural related single use facilities and light traffic facilities which generate up to 100 vehicle trips per day. This road is not applicable to any winery access. Applies to lightly traveled, low speed roads connecting two activity areas with no significant side traffic. Turnouts must be inter-visible.
- j) Split level Split level construction is applicable to all of the above categories if the design is satisfactory to the County Engineer.
- k) Special Purpose Way This applies to secondary access roads, emergency roads, bicycle paths, equestrian trails and other similar facilities when required by either the Fire Marshall, Public Works Director or County Code. The design will depend on each particular situation and be approved by the Public Works Director. Acceptable provisions for maintenance must be established and dedication may be required.

*Cul-de-sac situations with lengths greater than 1000 feet shall be provided with turn around areas at 1000 foot intervals and emergency access unless it is not considered feasible by the County Engineer.

14-15. DESIGN CRITERIA

Tabulated herein ~~is the design criteria~~ are the design criteria applicable to each of the standard subdivision roads "a" through "i" in terms of minimum design speed, minimum horizontal radius, minimum stopping sight distance, and maximum slopes. The radii shown are based on a negative cross slope of 2 percent which is typical for a subdivision street. If the street is super elevated, the radius can be reduced accordingly. All streets shall have a minimum longitudinal slope of 0.5 percent.

Roadway Width: All roads shall be constructed to provide a minimum of two nine-foot traffic lanes and two foot earth shoulder providing two-way traffic flow. Exception is made for special purpose roads and ~~rural-residential~~ driveways.

Roadway Surface: The surface shall provide unobstructed access to conventional drive vehicles. Road surfaces and structures shall be capable of supporting loads equivalent to the HS20-44 criterion (40,000 pound vehicle).

Road Radius: (a) No roadway shall have a horizontal inside radius of curvature of less than 50 feet and additional surface width of 4 feet shall be added to curves of 50-100 feet radius; 2 feet to those from 100-200 feet. (b) The length of vertical curves in roadways, exclusive of gutters, ditches, and drainage structures designed to hold or divert water, shall not be less than ~~100~~ 50 feet.

Roadway Turnarounds: Turnarounds are required on driveways and dead-end roads. The minimum turning radius for a turnaround shall be 40 feet from the center line of the road (detail C-12). If a hammerhead ~~T~~ is used, the top of the "T" hammerhead shall be a minimum of 60 feet in length. ~~(See detail C-13). An alternative to the hammerhead turnaround is the shunt turnaround (detail C-14). A turnaround other than those listed above can be designed and proposed for review to the County Engineer for possible acceptance of use.~~ ~~40.~~

Roadway Turnouts: Turnouts shall be a minimum of ~~40~~ 20 feet wide and 30 feet long with a minimum 25 foot taper on each end. See detail C-~~40~~ 11.

Roadway Structures:

(a) All driveway, road, and private lane roadway structures shall be constructed to carry at least the maximum load and provide the minimum vertical clearance of 15 feet;

(b) Appropriate signing, including but not limited to weight or vertical clearance limitations, one-way road or single lane conditions, shall reflect the capability of each bridge;

(c) A bridge with only one traffic lane shall provide for unobstructed visibility from one end to the other and turnouts at both ends. Either railing or a minimum 6" high curb of suitable material shall be provided along the lengths of both sides of bridges.

One-Way Roads: All one-way roads shall be constructed to provide a minimum of one 10-foot traffic lane. All one-way roads shall connect to a two-lane roadway at both ends, and shall provide access to an area currently zoned for no more than 10 dwelling units. In no case shall it exceed 2,640 feet in length. A turnout shall be placed and constructed at approximately the midpoint of each one-way road.

Dead-End Roads: (a) The maximum length of a dead-end road, including all dead-end roads access from that dead-end road shall not exceed the following cumulative lengths, regardless of the number of parcels served:

- Parcels zoned for less one acre..... 800 feet
- Parcels zoned for 1 acre to 4.99 acres 1,320 feet
- Parcels zoned for 5 acres to 19.99 acres 2,640 feet
- Parcels zoned for 20 acres or larger..... 5,280 feet

All lengths shall be measured from the edge of the roadway surface at the intersection that begins the road to end of the road surface at its farthest point. Where a dead-end road crosses areas of differing zoned parcel sizes, requiring different length limits, the shortest allowable length shall apply.

(b) Where parcels are zoned 5 acres or larger, turnarounds shall be provided at a maximum of 1,320 foot intervals.

(c) Each dead-end road shall have a turnaround constructed at its terminus.

Special Purpose Roads and Driveways: All special purpose roads and driveways shall provide a minimum 10 foot traffic travel lane and unobstructed vertical clearance of 15 feet along its entire length. (a) Special purpose roads and driveways exceeding 150 feet in length, but less than 800 feet in length, shall provide a standard turnout near the midpoint of the driveway. Where the special purpose road or driveway exceeds 800 feet, standard turnouts shall be provided no more than 400 feet apart. (b) A turnaround shall be provided at all

building sites on special purpose roads ~~or driveways over~~ exceeding 300 feet in length, and shall be within 50 feet of the building.

Residential Driveways: New residential driveways shall be constructed to provide 14 feet of travel way and unobstructed vertical clearance of 15 feet along its entire length. The travel way shall, at a minimum, consist of a 10 foot wide all weather surfaced travel lane with 4 feet of drivable shoulder (see detail C-10). The drivable shoulder may be placed on both sides of the travel lane with the total shoulder width summing to 4 feet. For new residential driveways between 150 and 800 feet in length, a standard inter-visible turnout shall be provided near the midpoint of the driveway as approved by the County Engineer. Where new residential driveways exceed 800 feet in length, standard inter-visible turnouts shall be provided no more than 400 feet apart (see detail C-11).

There are two types of Residential Driveways defined below:

Rural Area – A residential driveway connected to a rural County road per detail P-2.

Urban Area – A residential driveway connected to a County road with curb, gutter and sidewalk improvements and has a driveway approach per detail P-3.

For structure improvements, as defined in Item 12 of these standards, that are served by an existing residential driveway that does not meet current residential driveway standards, the existing residential driveway shall be improved to meet standards when possible or to the maximum extent practicable as approved by Cal Fire and the County Engineer. The turnout spacing for existing residential driveways shall be in accordance with the Table 14.1.

A turnaround shall be provided at all building sites on residential driveways and common drives exceeding 300 feet in length, and shall be within 50 feet of the building (see details C-12, C-13 or C-14).

Table 14.1

Turnout Spacing on Existing Driveways

<u>Level of Improvement</u>	<u>Number of Residential Units Served by Existing Driveway</u>					
	<u>6+</u>	<u>5</u>	<u>4</u>	<u>3</u>	<u>2</u>	<u>1</u>
<u>Improvement is between 0-50% of Existing Square Footage</u>	<u>400 ft</u>	<u>400 ft</u>	<u>400 ft</u>	<u>400 ft</u>	<u>400 ft</u>	<u>400 ft</u>
<u>Improvement is greater than 50% of Existing</u>	<u>300 ft</u>	<u>300 ft</u>	<u>300 ft</u>	<u>400 ft</u>	<u>400 ft</u>	<u>400 ft</u>

Formatted: Tab stops: 0.25", Left + 1.25", Left

Formatted: Indent: Left: 0", Hanging: 1.25", Tab stops: 0.25", Left + 1.25", Left

Formatted Table

Formatted: Font: (Default) Palatino Linotype, 18 pt

Formatted: Font: Palatino Linotype

Formatted: Font: Palatino Linotype

Formatted: Font: (Default) Palatino Linotype

Formatted: Font: (Default) Palatino Linotype, Italic

Formatted: Font: (Default) Palatino Linotype, Italic

Formatted: Font: (Default) Palatino Linotype

Formatted: Font: (Default) Palatino Linotype, Italic

Formatted: Font: (Default) Palatino Linotype

<u>Square Footage</u>						
<u>2nd Dwelling Unit</u>	<u>300 ft</u>	<u>300 ft</u>	<u>300 ft</u>	<u>300 ft</u>	<u>400 ft</u>	<u>400 ft</u>
<u>Primary Residence</u>	<u>250 ft</u>	<u>250 ft</u>	<u>250 ft</u>	<u>300 ft</u>	<u>300 ft</u>	<u>400 ft</u>
<u>Primary Residence with a 2nd Dwelling Unit</u>	<u>200 ft</u>	<u>200 ft</u>	<u>200 ft</u>	<u>250 ft</u>	<u>250 ft</u>	<u>400 ft</u>

Formatted: Font: (Default) Palatino Linotype, Italic

Formatted: Font: (Default) Palatino Linotype

Formatted: Font: (Default) Palatino Linotype, Italic

Formatted: Font: (Default) Palatino Linotype

Formatted: Font: (Default) Palatino Linotype, Italic

Formatted: Font: (Default) Palatino Linotype

Formatted: Font: (Default) Palatino Linotype, 11.5 pt

While turnouts spaced at the above noted distances would be ideal, Cal Fire and the County Engineer will work with applicant to space turnouts per site conditions. At a minimum the number of turnouts required shall be determined by dividing the total length of the driveway by the applicable spacing in the above table and rounding up to a whole number.

DESIGN CRITERIA CHART

Street	Min. Design Speed (mph)	Min. Centerline Radius (ft)	Min. Stopping Sight Distance (ft)	Max. Grade (%)
Arterial				
Type I	40	825	275	8
Type II	35	585	225	12
Collector				
Type I	35	585	225	10
Type II	25	220	150	15
General Minor				
Type I	20	220	150	15
Type II	20	120	110	20
Loop Road and Non Continuous Minor				
Type I	20	120	110	15
Type II	15	50	75	20
Cul-de-Sac				
Type I	20	120	110	15
Type II	15	50	75	20
One Way Loop road				
Type I	20	120	110	15*
Type II	15	50	75	20*
Common Drives				
Type I	15	50	75	15
Type II	15	50	75	20
<u>Rural-Residential</u> Driveway	15	50	75	16**
Agricultural Special Purpose Road	Level 30mph Rolling 20 mph Mountain 10 mph	400 120 50	400 250 100	16** 16** 16**

*When the sight distance falls below 220 feet for Type I or for a Type II One Way Loop, the minimum paved width shall not be less than 18 feet.

**Grades for Rural-Residential Driveways and Agricultural Special Purpose Roads may be increased to a maximum of 20% when the road surface is paved per surfacing requirements provided in detail C-10.

15-16. INDUSTRIAL AND COMMERCIAL DEVELOPMENT

Industrial references in these standards are applicable to all appropriately zoned lands whether hillside (average slope of 10 percent%) or flatter areas. In general, the "high density" portions of these standards are applicable to industrial development.

Road cross sections for existing County roads and State highways which have ultimate status widths different from these standards shall be improved to provide additional pavement width and thickness plus additional right of way, all as determined by the County Engineer.

Structural pavement sections shall be based upon a minimum traffic index of 6.0 and appropriate "R" value.

Bus turnouts and related sidewalks may be required as a condition of development.

Where on-street parking is allowed, a sidewalk shall be provided on the same side of the street as the parking lane. The sidewalk shall be portland-Portland cement-Cement concreteConcrete. Where no sidewalk is required, an unpaved, clear walkway shall be provided.

Consistent with the Board policy of accepting into the road system only those roads improved to County standards, any new roads or drainage improvements proposed under a parcel map or subdivision map to be accepted for maintenance by County or County service area shall first be improved to ultimate status in accordance with the standards.

In any land divisions where road and drainage improvements are proposed to be privately maintained, the developer shall furnish covenants calling for maintenance of such improvements. Covenants shall run with the land and be recorded with the final map or parcel map.

16-17. TRAFFIC CONTROL DEVICES

The Caltrans-California Manual on Uniform Traffic Control Devices (California MUTCD), the Caltrans Standard Specifications and the Caltrans Highway Design manual shall be utilized to determine traffic warrants, design and construction procedures for all traffic control devices with the exception of left-turn lanes. Warrants for construction of a left-~~turn~~ turn lane on County Maintained roads as defined in Sections 18.112.040 through 18.112.080 of the County Code shall be as follows:

Left-Turn Lane Warrants: Use Permits or modifications thereof shall trigger the application of the following warrants to determine the necessity for a left-turn lane for entering the proposed use.

1. Application of the following Left-Turn Lane Warrant ~~chart~~[Graph](#) based on Road [average daily trips \(ADT\)](#) and projected ADT of use. The ~~chart~~ is a representation of probable conflict between turning traffic and advancing traffic. Private Road or Driveway ADT is the total average daily traffic utilizing the facility. A left-turn lane will not be considered for uses generating an ADT of 10 or less.
2. If ~~the corner~~ sight distance in advancing direction, measured from the driveway, is less than required per Caltrans design standards (usually the posted speed limit multiplied by eleven, read in feet) a left-turn lane shall be installed.
3. If traffic conditions or turning movements pose a considerable threat to public life and safety, as recognized by the Director of Public Works, a left-turn lane shall be installed.

Design: Design of the Left-turn lane shall be prepared by a Licensed Civil Engineer and be based on the County Standard Detail L-TL-~~41~~, available at the Public Works Department. [Installation of a left turn lane on a public road shall require an encroachment permit issued by the Napa County Roads department and the property owner shall be required to enter into a one \(1\) year maintenance agreement including appropriate bonding.](#)

18. TYPICAL CROSS SECTIONS

The cross sections which follow are intended to represent typical applications in subdivision development and do not include all possibilities or elements of design that may be required or permitted. The minimum right of way for any public street or road will not be less than forty feet. In addition, slope easements extending ten feet beyond the top of cut or toe of fill will be required whenever the vertical height of the cut or fill exceeds five feet. Easements are not required when cut or fill slopes are flatter than 3:1.

Please note that for simplification, mountable curb is not shown on the typical sections. When it is used, the sidewalks must be located as shown on the Standard Details. Fill slopes higher than 10 feet will be protected with asphalt concrete dikes or other acceptable means. Super elevations and continuous cross slope streets without a crown may be permitted and encouraged in specific cases upon the approval of the County Engineer.

LEFT TURN LANE WARRANT GRAPH

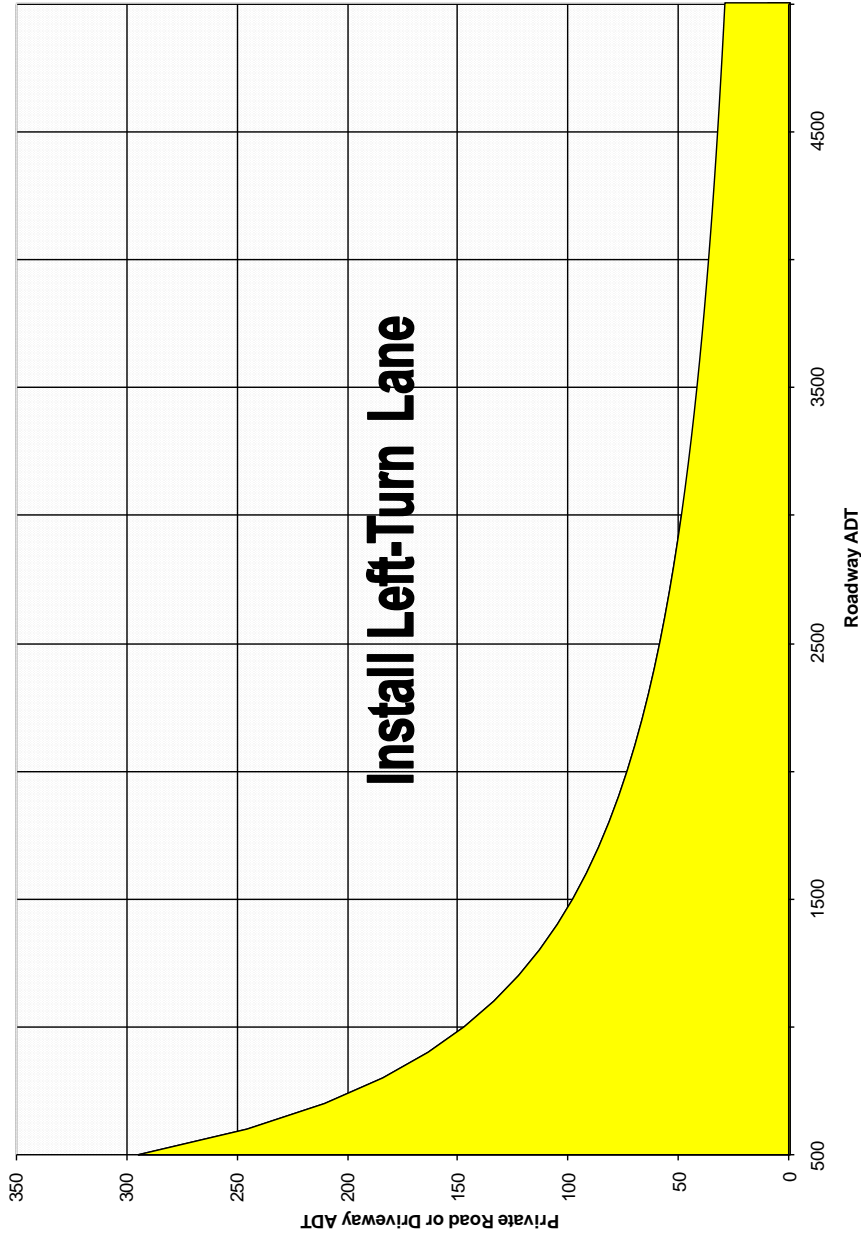

■ No Left-Turn Lane Necessary

Formatted: Font: (Default) Palatino Linotype, 11.5 pt

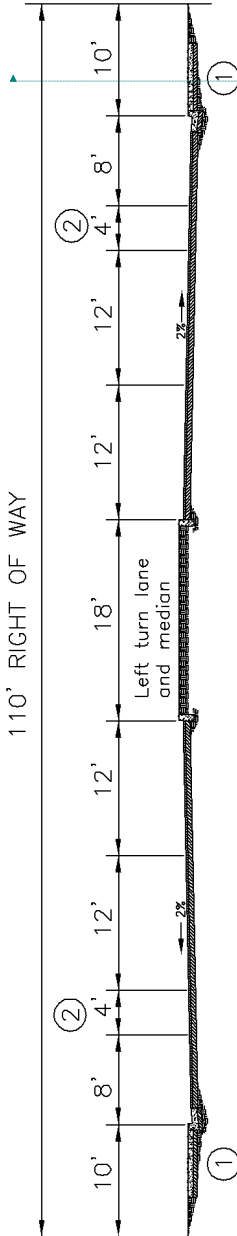

4 LANE ARTERIAL WITH MEDIAN
TYPE I HIGH DENSITY

- 1. 10' P.C.C. SIDEWALK IN COMMERCIAL AREAS. 6' P.C.C. SIDEWALK IN RESIDENTIAL AREAS.
- 2. BIKE LANE

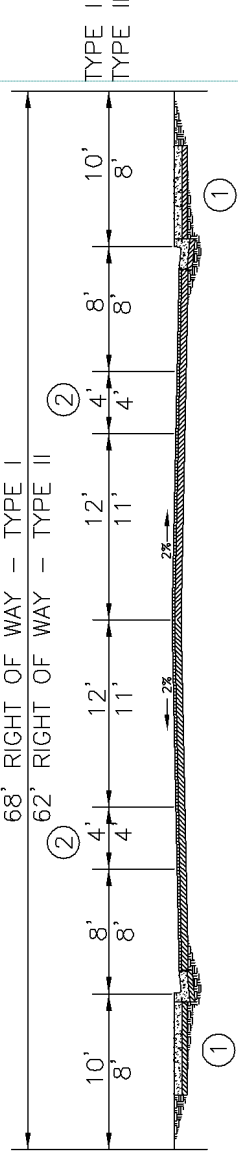

2 LANE ARTERIAL WITH PARKING
TYPES I & II, HIGH DENSITY

- 1. 6' P.C.C. SIDEWALK.
- 2. BIKE LANE.

NOT TO SCALE

ARTERIAL CROSS SECTIONS
DESIGN SPEED - 40 M.P.H. FOR TYPE I, 35 M.P.H. FOR TYPE II
A.D.T. 5,000 OR MORE VEHICLES PER DAY

COUNTY OF NAPA
DEPT. OF PUBLIC WORKS

DATE: JANUARY 1999

Samuel H. Johnson
COUNTY ENGINEER
RCE 17985

Formatted: Centered

Formatted: Font: 12 pt

Formatted: Heading 2, Centered, Indent:
First line: 0", Adjust space between Latin and Asian text, Adjust space between Asian text and numbers

ARTERIAL C-1 ARTERIAL CROSS SECTIONS

[Insert Cross Sections]

Detail C-1

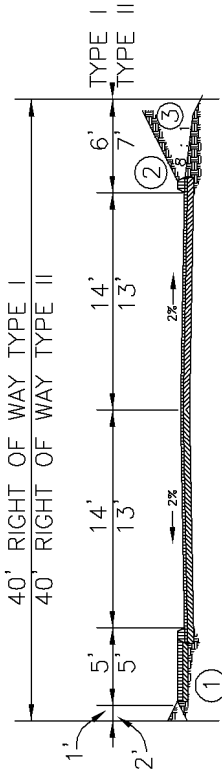

2 LANE ARTERIAL W/O PARALLEL
PARKING LANES - LOW DENSITY

1. 4' A.C. SIDEWALK ON FILL SIDE.
2. A.C. DIKE IN CUT AREAS. BERM REQUIRED WHERE FILL HEIGHT EXCEEDS 10 FEET.
3. 4' SHOULDER IN FILL AREA.

NOT TO SCALE

ARTERIAL CROSS SECTIONS
COUNTY OF NAPA
DEPT. OF PUBLIC WORKS

DESIGN SPEED - 40 M.P.H. FOR TYPE I, 35 M.P.H. FOR TYPE II
A.D.T. 5,000 OR MORE VEHICLES PER DAY

DATE: JANUARY 1999

Samuel B. H. Johnson
COUNTY ENGINEER

RCE 17985

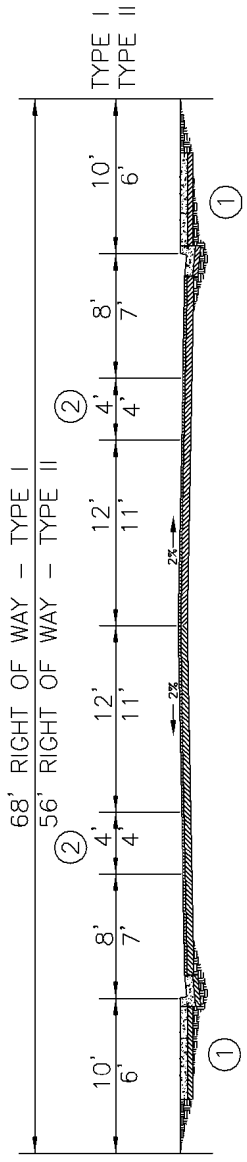

COLLECTOR WITH PARALLEL PARKING LANES
HIGH DENSITY

1. 5' P.C.C. SIDEWALK.
2. BIKE LANE.

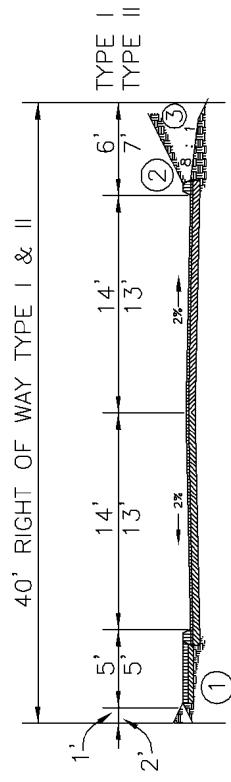

COLLECTOR WITHOUT PARALLEL
PARKING LANES - LOW DENSITY

1. 4' A.C. SIDEWALK ON FILL SIDE.
2. A.C. DIKE IN CUT AREA. BERM REQUIRED WHERE FILL HEIGHT EXCEEDS 10 FEET.
3. 4' SHOULDER IN FILL AREA.

NOT TO SCALE

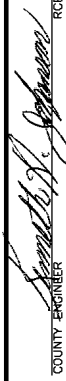
COLLECTOR CROSS SECTIONS	DESIGN SPEED - 35 M.P.H. FOR TYPE I, 25 M.P.H. FOR TYPE II A.D.T. 1,000 TO 5,000 VEHICLES PER DAY
COUNTY OF NAPA DEPT OF PUBLIC WORKS	DATE: JANUARY 1999
	 COUNTY ENGINEER RCE 17955

Formatted: Font: BankGothic Lt BT, Italic
Formatted: Font: BankGothic Lt BT, Italic

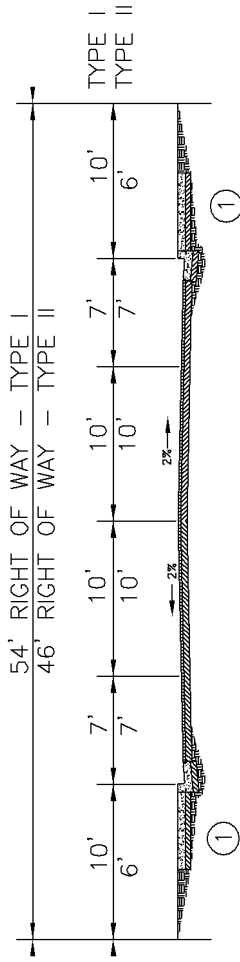

GENERAL MINOR WITH PARALLEL PARKING LANES, HIGH DENSITY

1. 5' P.C.C. SIDEWALK.

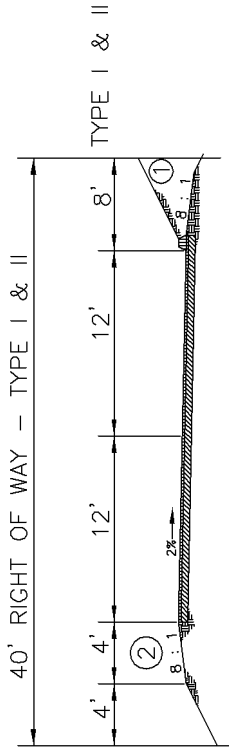

GENERAL MINOR WITHOUT PARALLEL PARKING LANES - LOW DENSITY

1. A.C. DIKE IN CUT AREAS. BERM REQUIRED WHERE FILL HEIGHT EXCEEDS 10 FEET.
2. 4' SHOULDER IN FILL AREAS.

NOT TO SCALE

GENERAL MINOR CROSS SECTIONS
 COUNTY OF NAPA
 DEPT. OF PUBLIC WORKS

DESIGN SPEED - 25 M.P.H. FOR TYPE I, 20 M.P.H. FOR TYPE II
 A.D.T. UP TO 1,000 VEHICLES PER DAY

DATE: JANUARY 1999

Samuel W. Johnson
 COUNTY ENGINEER
 RCE 17595

Formatted: Heading 2, Centered

Formatted: Font: BankGothic Lt BT, Italic

Formatted: Font: BankGothic Lt BT, Italic

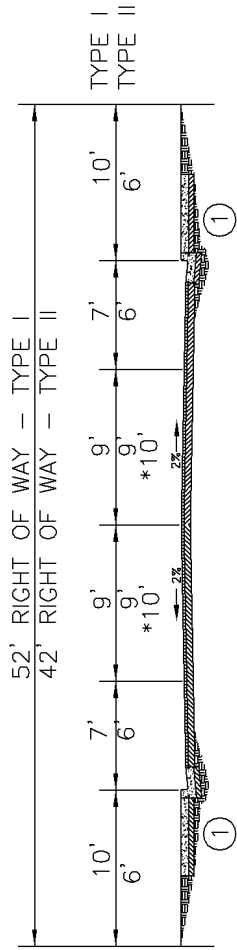

WITH PARALLEL PARKING LANES, HIGH DENSITY

MINIMUM CUL-DE-SAC RADIUS FOR TYPE I & II IS 40' TO FACE OF CURB.

1. 5' P.C.C. SIDEWALK.
- *NOTE: INCREASE DRIVING LANE WIDTH TO 10' WHEN LENGTH EXCEEDS 1,000' & EMERGENCY ACCESS IS NOT PROVIDED.

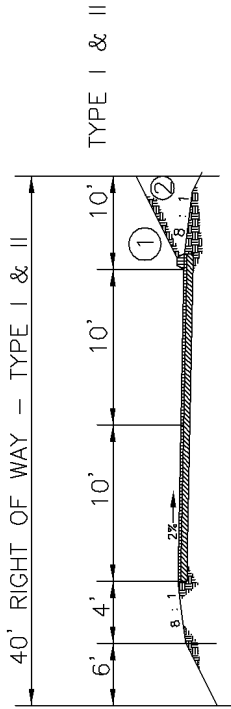

WITHOUT PARALLEL PARKING LANES, LOW DENSITY

MINIMUM CUL-DE-SAC RADIUS FOR TYPE I & II IS 40' TO EDGE OF PAVEMENT.

1. A.C. DIKE IN CUT AREAS. BERM REQUIRED WHERE FILL HEIGHT EXCEEDS 10 FEET.
2. 4' SHOULDER IN FILL AREAS.

NOT TO SCALE

NON-CONTINUING MINOR,
LOOP ROAD & CUL-DE-SAC

COUNTY OF NAPA
DEPT. OF PUBLIC WORKS

DATE: JANUARY 1999

Franklin S. Johnson
COUNTY ENGINEER

Formatted: Font: (Default) Palatino Linotype, 12 pt, Bold, Small caps

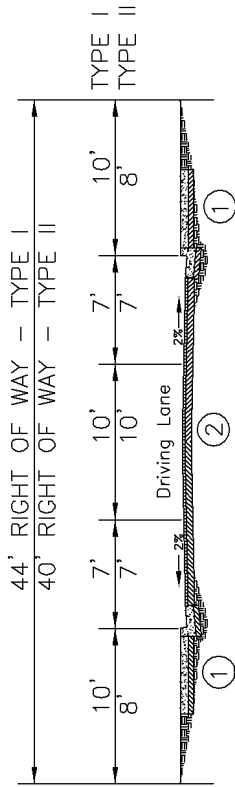

ONE WAY LOOP ROAD WITH PARALLEL PARKING LANES
HIGH DENSITY

1. 5' P.C.C. SIDEWALK.
2. PARKING LANES MUST BE DELINEATED.

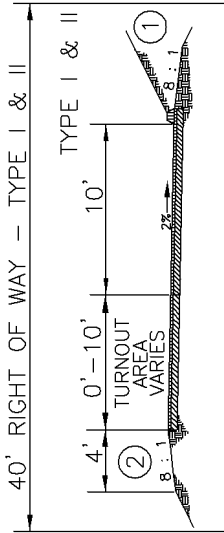

ONE WAY LOOP ROAD WITHOUT PARALLEL PARKING LANES
LOW DENSITY

1. A.C. DIKE IN CUT AREAS. BERM REQUIRED WHERE FILL HEIGHT EXCEEDS 10'.
 2. 4' SHOULDER IN FILL AREAS.
- NOTE: INCREASE PAVEMENT WIDTH TO 16' WHEN STOPPING SIGHT DISTANCE IS LESS THAN 200' FOR TYPE I, OR 150' FOR TYPE II.

NOT TO SCALE

ONE WAY LOOP CROSS SECTIONS
DESIGN SPEED - 20 M.P.H. FOR TYPE I, 15 M.P.H. FOR TYPE II
A.D.T. UP TO 100 VEHICLES PER DAY

COUNTY OF NAPA
DEPT. OF PUBLIC WORKS

DATE: JANUARY 1999

Samuel H. Johnson
COUNTY ENGINEER
REF: 7895

Formatted: Font: Palatino Linotype, 11.5 pt

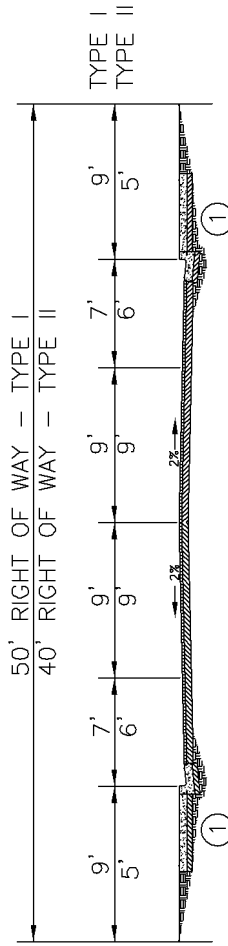

COMMON DRIVE WITH PARALLEL PARKING LANES
HIGH DENSITY

- 1. 5' P.C.C. SIDEWALK.

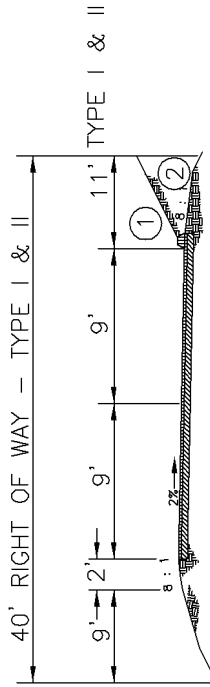

COMMON DRIVE WITHOUT PARALLEL PARKING LANES
LOW DENSITY

- 1. A.C. DIKE IN CUT AREAS. BERM REQUIRED WHERE FILL HEIGHT EXCEEDS 10 FEET.
- 2. 2' SHOULDER IN FILL AREAS.

NOT TO SCALE

COMMON DRIVE
CROSS SECTIONS

DESIGN SPEED — 15 M.P.H. FOR TYPE I & II,
SERVES UP TO 6 DWELLING UNITS

COUNTY OF NAPA
DEPT. OF PUBLIC WORKS

DATE: JANUARY 1999

Samuel H. Johnson
COUNTY ENGINEER
RCE 17995

Formatted: Font: Palatino Linotype, 11.5 pt

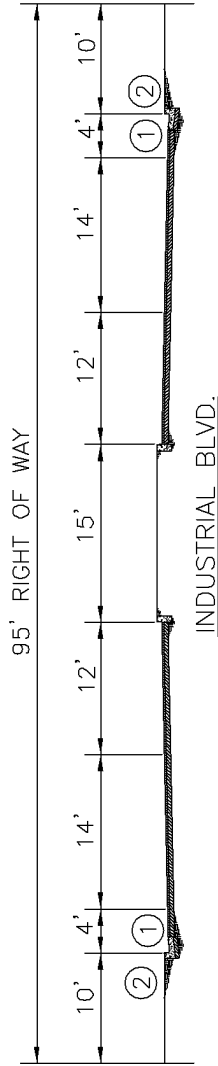

INDUSTRIAL BLVD.

- 1. BIKE LANE AND EMERGENCY PARKING.
- 2. NO PRIVATE DRIVEWAY CONNECTIONS.

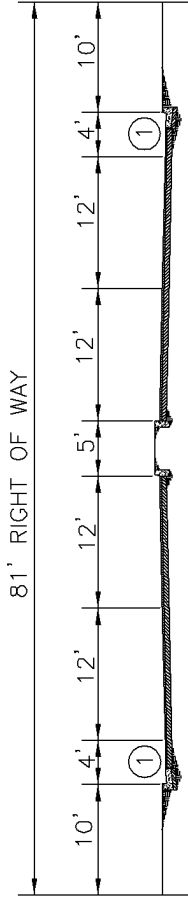

INDUSTRIAL 4 LANE COLLECTOR

- 1. BIKE LANE AND EMERGENCY PARKING.

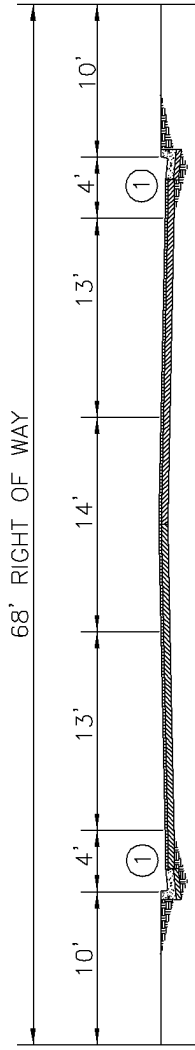

INDUSTRIAL 3 LANE COLLECTOR

- 1. BIKE LANE AND EMERGENCY PARKING.

NOT TO SCALE

INDUSTRIAL COLLECTORS

COUNTY OF NAPA
DEPT. OF PUBLIC WORKS

DATE: JANUARY 1999

Samuel H. Johnson
COUNTY ENGINEER

RCE 17995

Formatted: Font: Palatino Linotype, 11.5 pt

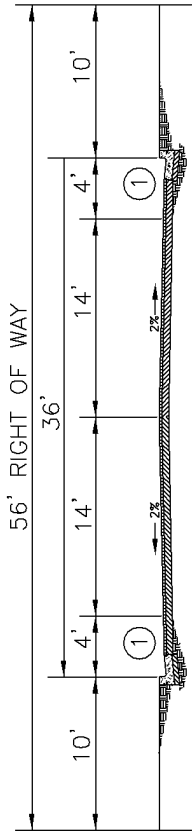

INDUSTRIAL 2 LANE COLLECTOR

1. BIKE LANE AND EMERGENCY PARKING.

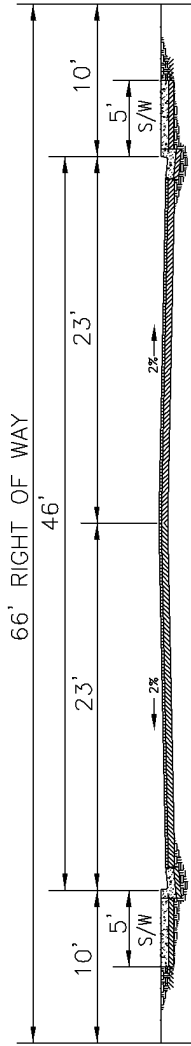

INDUSTRIAL MINOR
(ON-STREET PARKING)

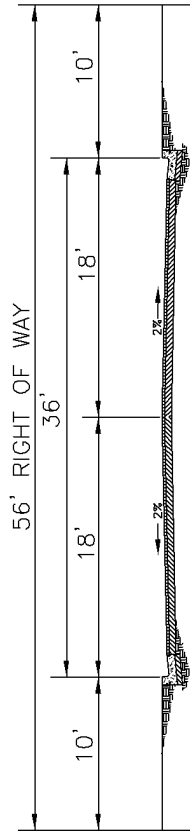

INDUSTRIAL MINOR
(NO PARKING)

NOT TO SCALE

INDUSTRIAL COLLECTOR AND INDUSTRIAL MINOR

COUNTY OF NAPA
DEPT. OF PUBLIC WORKS

DATE: JANUARY 1999

Signature
COUNTY ENGINEER
RCE 17995

Formatted: Font: Palatino Linotype, 11.5 pt

- ① PRIVATE ACCESS EASEMENT SHALL BE OF SUFFICIENT WIDTH TO ACCOMMODATE ALL NECESSARY IMPROVEMENTS TO ACHIEVE THE STANDARD DRIVEWAY WIDTH AND SHALL NOT BE LESS THAN 25 FEET.
- ② ASPHALT BERM REQUIRED WHEN FILL HEIGHT EXCEEDS 10 FEET OR IN CUT AREAS.
- ③ A DRIVEABLE SWALE MAY BE USED AS PART OF TRAVEL LANE WHEN APPROVED BY COUNTY ENGINEER AND CAL FIRE.
- ④ CROSS SLOPE SHALL BE PROVIDED TO PREVENT WATER PONDING IN TRAVEL WAY AND SHALL NOT EXCEED 5%.

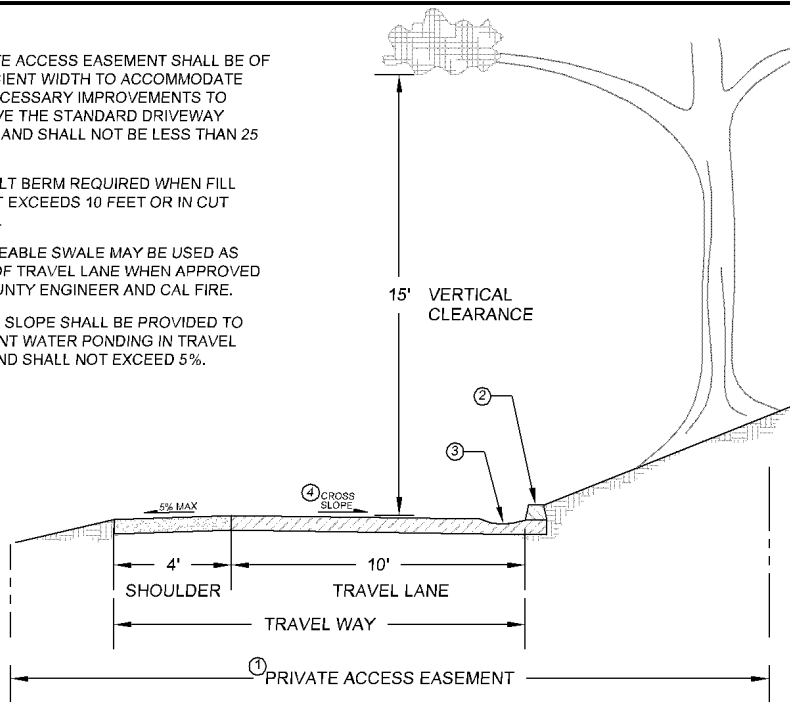

NOTES:

- 1. SEE SECTION 14 OF THESE STANDARDS FOR DESIGN CRITERIA.
- 2. ROAD SURFACING REQUIREMENTS FOR TRAVEL LANE (APPLIES TO RESIDENTIAL DRIVEWAYS AND AGRICULTURAL SPECIAL PURPOSE ROADS):

TRAVEL LANE ALL WEATHER SURFACE OPTIONS	RANGE OF ∇ GRADE FOR SURFACE OPTION
5" CL. 2 AB	0% - 5% (MAX)
5" CL. 2 AB WITH DOUBLE SEAL COAT	0% - 16% (MAX)
2" HMA / 5" CL. 2 AB	0% - 20% (MAX)

3. SEE THE FOLLOWING DETAILS FOR DESIGN OF DRIVEWAY APPURTENANCES:

- > CONNECTION TO COUNTY ROAD - DETAIL P-2 (RURAL) OR DETAIL P-5 (URBAN)
- > STANDARD DRIVEWAY TURNOUT - DETAIL C-11
- > STANDARD DRIVEWAY TURNAROUND - DETAIL C -12 OR DETAIL C-13

4. PROVIDE REFLECTOR TYPE ADDRESS NUMBER PLACARDS WITH 3" MIN. LETTER HEIGHT AT PUBLIC ROAD AND DRIVEWAY INTERSECTIONS.

NOT TO SCALE

COUNTY OF NAPA
DEPT. OF PUBLIC WORKS
RESIDENTIAL DRIVEWAY OR
AGRICULTURAL SPECIAL
PURPOSE ROAD

[Signature]
COUNTY ENGINEER RCE 51790

JUNE 2011

Formatted: Font: BankGothic Lt BT, Italic

Formatted: Centered

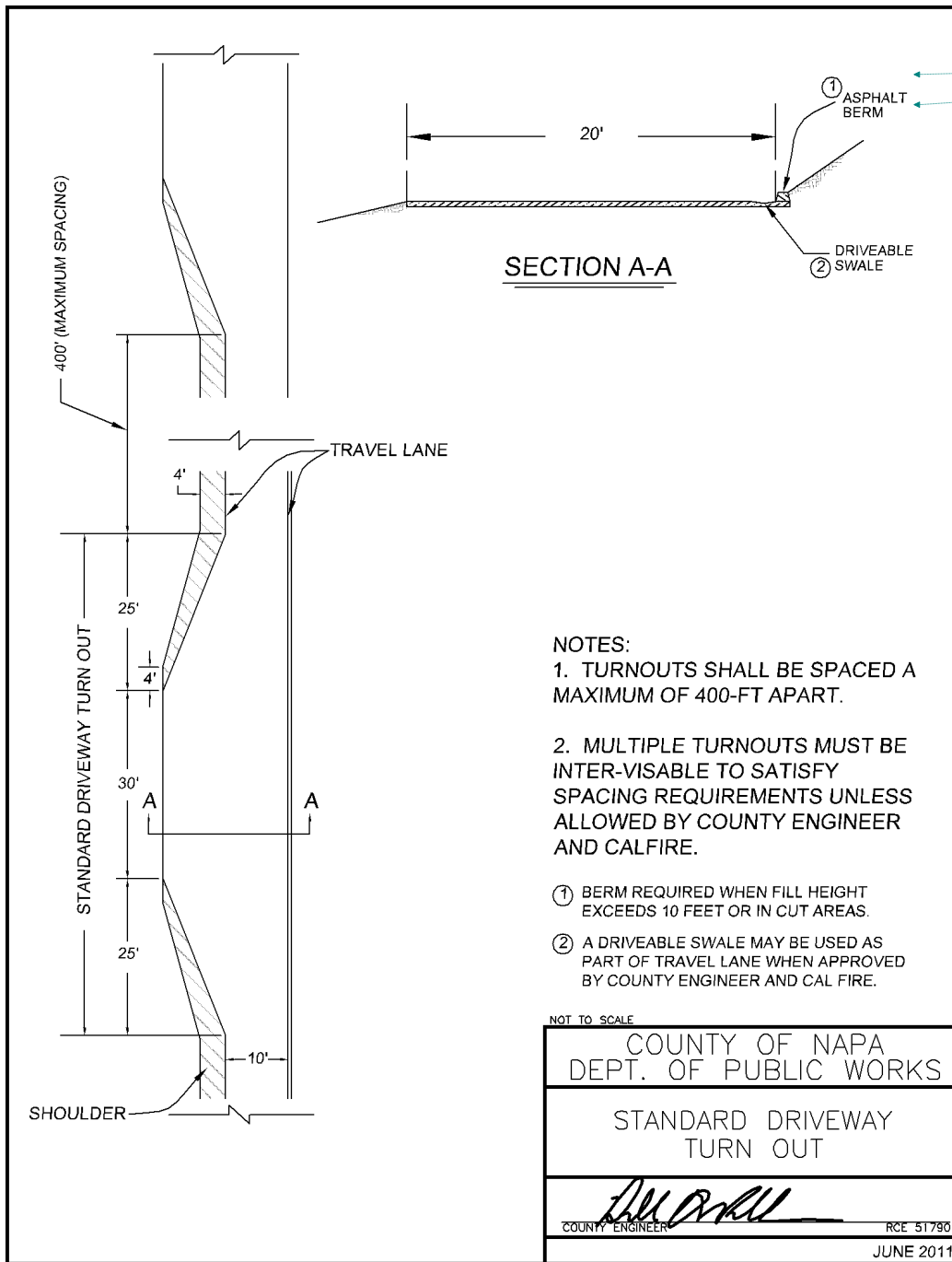

Formatted: Normal, Left
 Formatted: Centered

- NOTES:
1. TURNOUTS SHALL BE SPACED A MAXIMUM OF 400-FT APART.
 2. MULTIPLE TURNOUTS MUST BE INTER-VISABLE TO SATISFY SPACING REQUIREMENTS UNLESS ALLOWED BY COUNTY ENGINEER AND CALFIRE.
- ① BERM REQUIRED WHEN FILL HEIGHT EXCEEDS 10 FEET OR IN CUT AREAS.
 ② A DRIVEABLE SWALE MAY BE USED AS PART OF TRAVEL LANE WHEN APPROVED BY COUNTY ENGINEER AND CAL FIRE.

NOT TO SCALE

COUNTY OF NAPA
 DEPT. OF PUBLIC WORKS

STANDARD DRIVEWAY
 TURN OUT

[Signature]
 COUNTY ENGINEER RCE 51790

JUNE 2011

Formatted: Font: BankGothic Lt BT, Italic
 Formatted: Centered
 Formatted: Font: BankGothic Lt BT, Italic

Formatted: Heading 2 Char
 Formatted: Heading 2 Char
 Formatted: Font: 11.5 pt

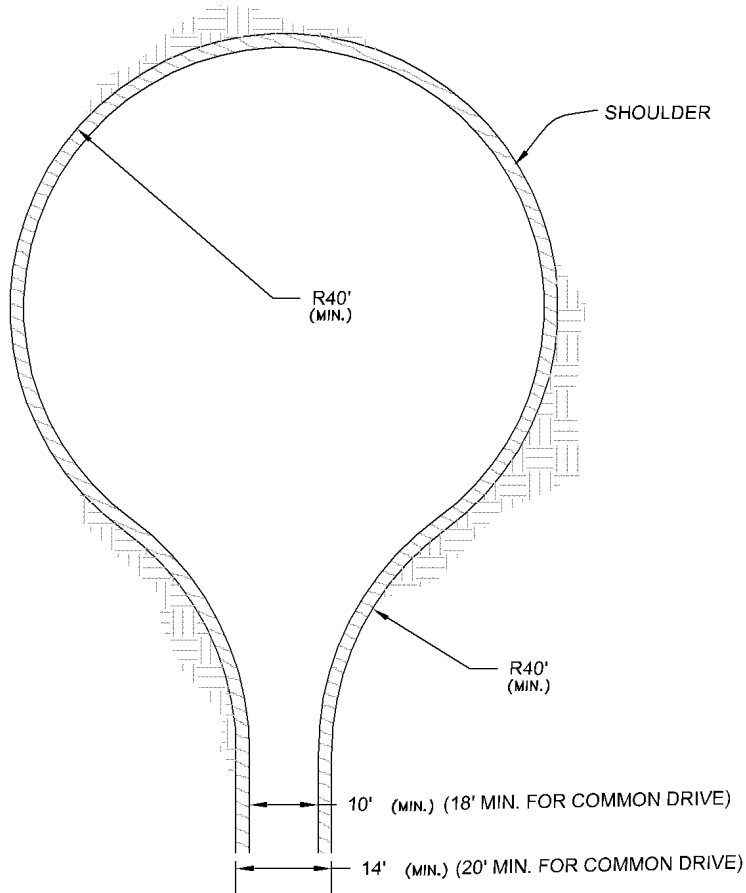

NOTES:
 1. TURNAROUND FACILITIES SHALL BE PROVIDED WITHIN 50 FEET OF BUILDING FOR LARGE FIRE ENGINES.

NOT TO SCALE

COUNTY OF NAPA DEPT. OF PUBLIC WORKS	
STANDARD BULB TURNAROUND	
<i>Bill Orville</i>	
COUNTY ENGINEER	RCE 51790

JUNE 2011

Formatted: Font: BankGothic Lt BT, Italic
 Formatted: Centered
 Formatted: Font: BankGothic Lt BT, Italic

Formatted: Heading 2, Centered

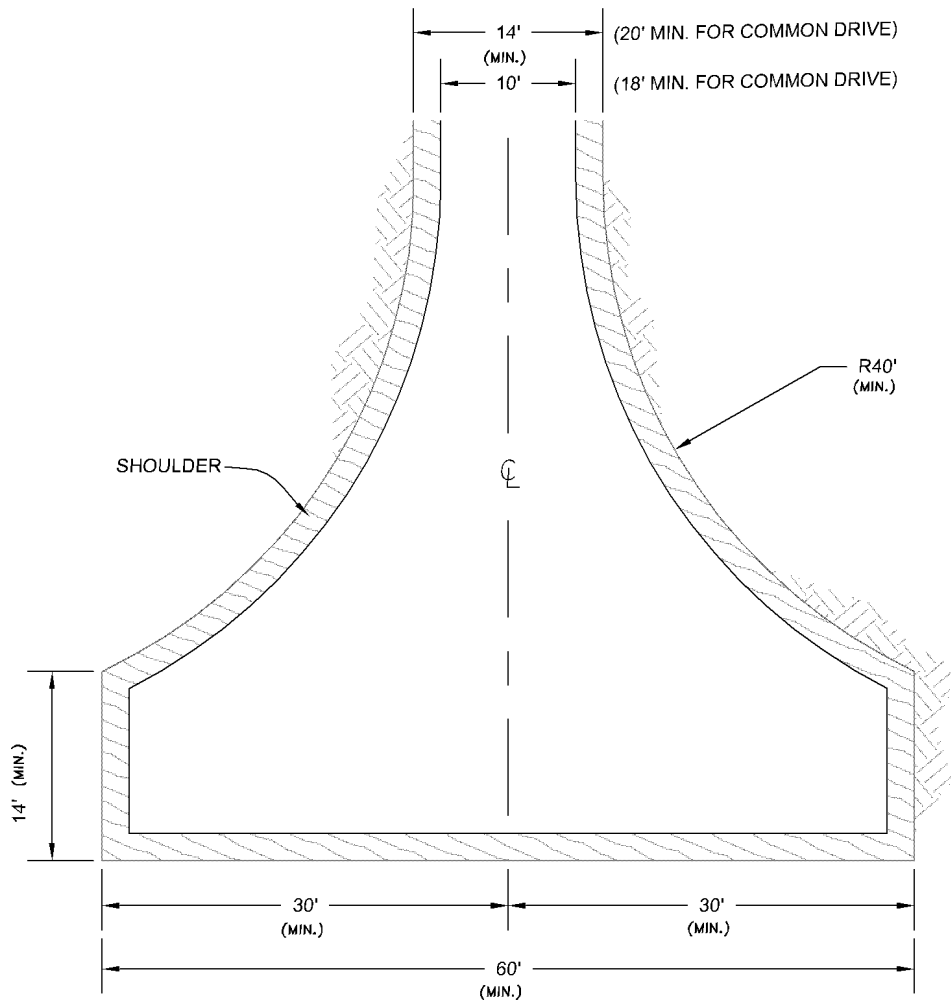

NOTES:
1. TURNAROUND FACILITIES SHALL BE PROVIDED WITHIN 50 FEET OF BUILDING FOR LARGE FIRE ENGINES.

NOT TO SCALE

COUNTY OF NAPA DEPT. OF PUBLIC WORKS	
STANDARD HAMMERHEAD TURNAROUND	
COUNTY ENGINEER <i>[Signature]</i>	RCE 51790
JUNE 2011	

Formatted: Font: BankGothic Lt BT, Italic
Formatted: Font: BankGothic Lt BT, Italic
Formatted: Centered

Formatted: Font: 11.5 pt

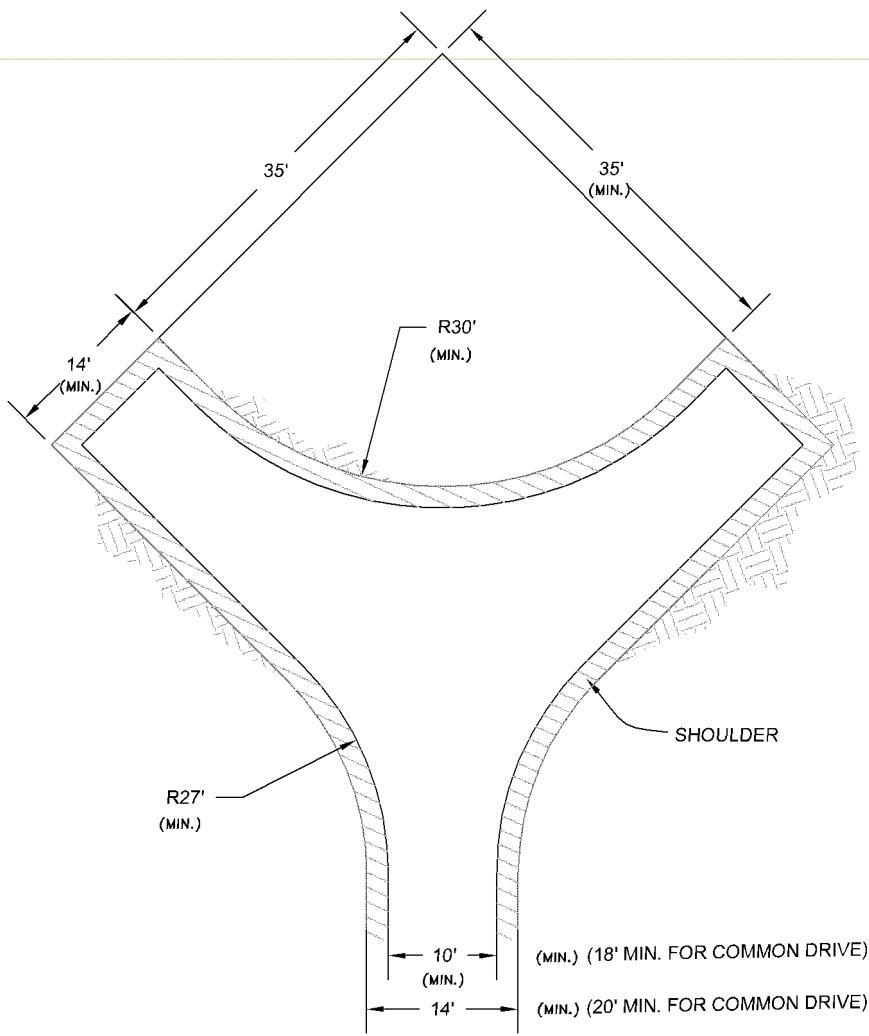

NOTES:
1. TURNAROUND FACILITIES SHALL BE PROVIDED WITHIN 50 FEET OF BUILDING FOR LARGE FIRE ENGINES.

NOT TO SCALE

COUNTY OF NAPA DEPT. OF PUBLIC WORKS	
RESIDENTIAL DRIVEWAY SHUNT TURNAROUND	
 COUNTY ENGINEER	RCE 51790
JUNE 2011	

Formatted: Font: BankGothic Lt BT, Italic
Formatted: Font: BankGothic Lt BT, Italic
Formatted: Centered

| 18-19.

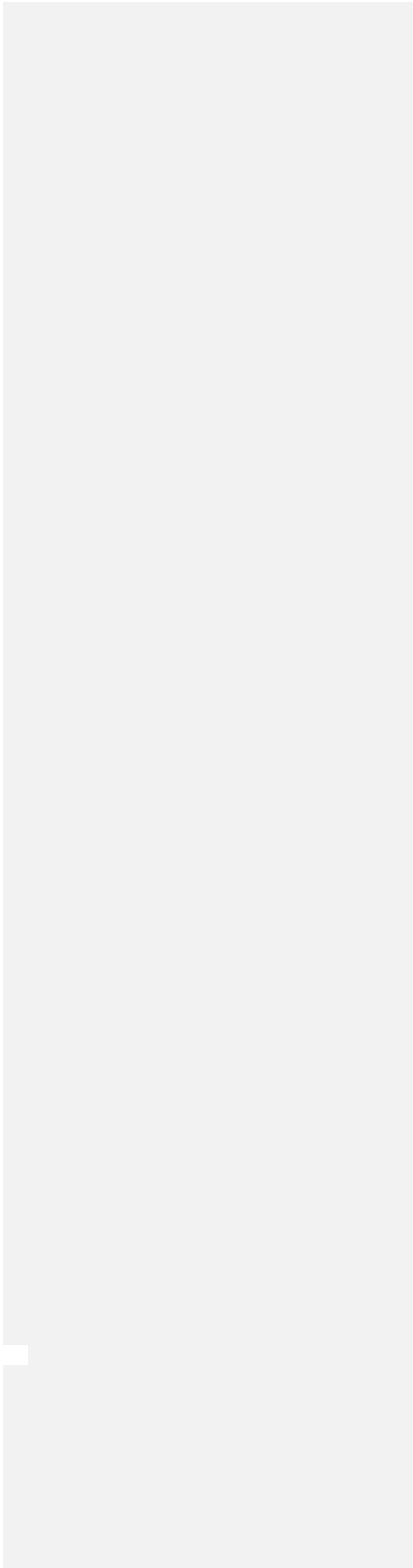

DETERMINATION OF TRAFFIC VOLUMES

Traffic volumes for subdivision roads will be computed on the basis that each single family dwelling unit generates an average of ten trips per day. The Developer's engineer is required to submit a traffic analysis showing the calculated traffic volumes for all streets in the subdivision and the estimated pattern of traffic flow plus any other data that would have a bearing on the proper street classification. This report shall be submitted with the preliminary subdivision map to enable an early determination of the street and road system to be used. The traffic analysis shall include existing and projected 10 year truck traffic volumes. T.I. adjustments of anticipated truck trips are not included in Figure 1. Adjustments to the T.I. shall be made to account for the truck traffic.

The report will be reviewed by the County Engineer using estimated traffic flow patterns based on the layout of each development and normal driver behavior, and the street classifications will be determined. Planned unit developments, and other types that may have unique traffic characteristics will be investigated on an individual basis.

19-20. DETERMINATION OF STRUCTURAL SECTION

Pavement design will be based on ~~State of California Department of Transportation (CALTRANS)~~ Caltrans design procedures using traffic index and resistance value as the design variable. Traffic index values will be developed by the County Engineer based on Figure 1 which shows the relationship between the number of houses served and the traffic index.

Resistance values will be furnished by the developer and will be based on soil tests taken at proposed sub-grade at intervals of 500 feet and/or where there is a definite change in the soil conditions. The lowest resistance value will be used for design unless it can be shown that the material is substantially different than that used in the other tests. In heavy clay soils, expansive conditions may be encountered that will require special attention. The use of soil stabilization to increase the resistance value may be allowed in certain instances upon approval of the County Engineer. The accompanying chart (Figure 2) gives minimum values of surfacing and base and total section thickness for various traffic indices. Seal coat pavements may be used on minor roads if the structural section is adequate for the Traffic index and soil conditions.

Minimum pavement section shall be 2 inches of ~~asphalt concrete (A.C.)~~ HMA and 5 inches of Class 2 ~~Aggregate Base~~ AB or a structural equivalent, with the exception of an Agricultural Special Purpose Road of which a minimum section shall be a double seal coat and 5 inches of Class 2 ~~Aggregate Base~~ AB or a structural equivalent. ~~Rural Residential driveways in the rural area Driveways need not be paved shall meet surfacing requirements per detail C-10.~~ The pavement structural section shall be constructed in accordance with the requirements of the Caltrans Standard Specifications. A.C. to be furnished for road construction shall be Caltrans Type B and shall be in conformance with the latest A.C. mix design with Section 27 of these standards.

CHART FOR ESTIMATION OF TRAFFIC INDEX
USING A HOUSE COUNT

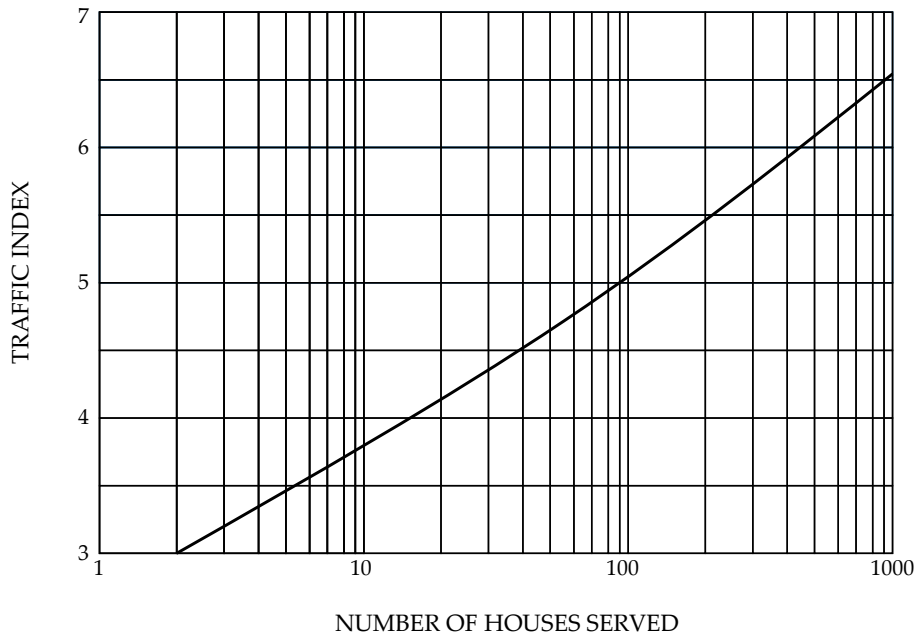

Notes: For use only within subdivisions for residential and residential collector streets.

Chart is based on a 10 – year design life.

Fig.

Formatted: Font: BankGothic Lt BT

Formatted: Centered

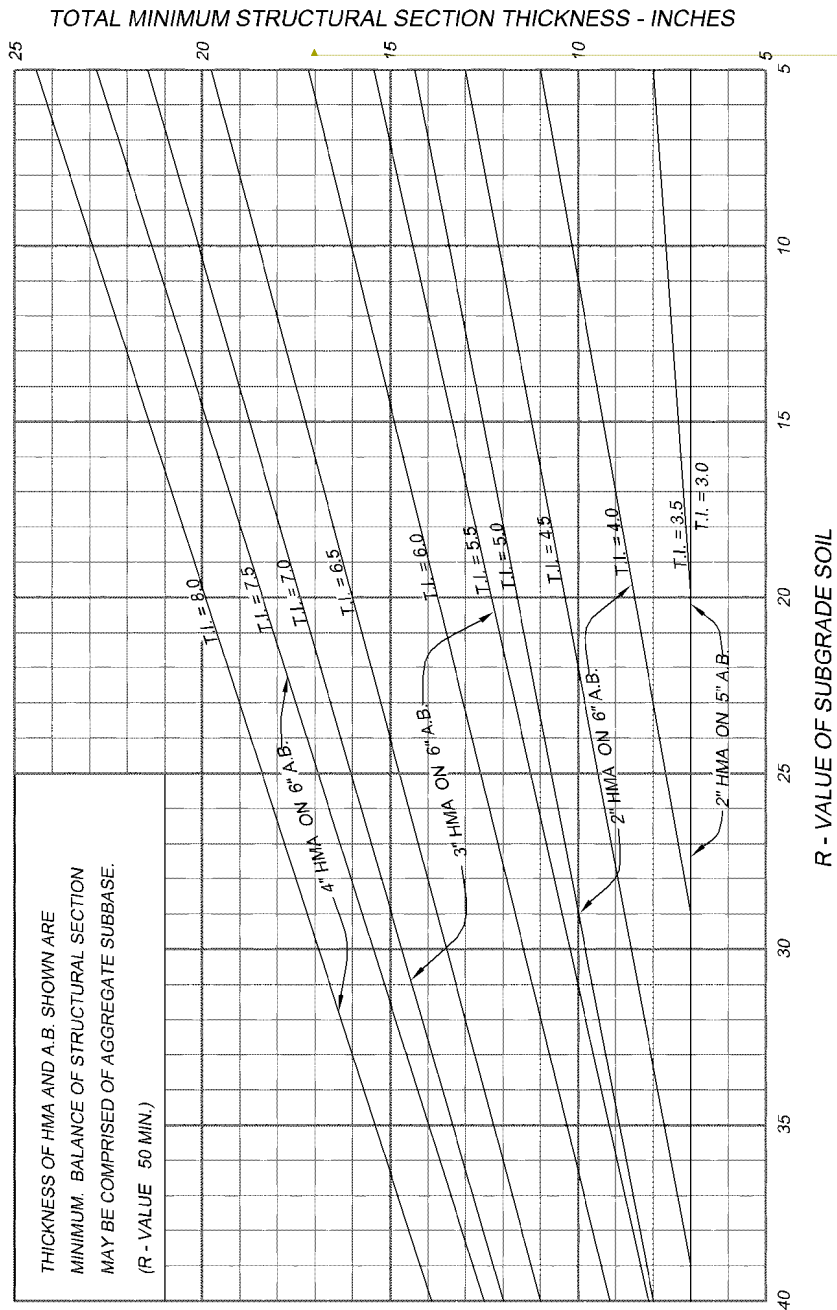

Formatted: Font: Palatino Linotype, 11.5 pt

Figure 2

Formatted: Font: BankGothic Lt BT

Formatted: Centered

20-21. GRADING REQUIREMENTS AND SOILS INVESTIGATIONS (FOR ROADS)

Geologic investigations will be required in all Type II (hill area) developments 40 acres or more in size to determine safe cut and fill slopes and unusual soils situations, and may be required on smaller parcels if considered necessary by the County Engineer. In the absence of soils tests, all cut and fill slopes shall be flatter than 2: 1; flatter slopes to conform to the existing terrain are encouraged. Slope rounding at the top of cuts and toe of fills is required under all conditions. In addition, all cut and fill slopes except in rock shall be seeded with durable, hardy species of grass or other acceptable plants or grasses that do not require irrigation. Geologic reports and soil investigations will conform to criteria set by the County Engineer.

21-22. DRAINAGE REQUIREMENTS

General:

The purpose of drainage improvements is to provide protection from flooding and reduce or eliminate maintenance costs and erosion damage. Erosion is particularly troublesome in hill areas and whatever steps deemed necessary will be taken to reduce erosion and its attendant problems. The paved roadbed shall be used wherever possible to carry runoff, and the typical sections may be modified to accomplish this. Concentrated runoff shall not be discharged onto native ground under any circumstances.

- a) Minimum Pipe Size: 18" in ~~diameter~~-diameter or equivalent
- b) Material: Metal, concrete or high density polyethylene plastic (Up to 36 inch diameter, corrugated outer wall and smooth inner liner) pipes are suitable for culverts: concrete shall generally be used for comprehensive drainage systems. Cast-in- place concrete pipe is not allowed in the County right-of-way. Concrete pipe shall be Class III minimum. When metal pipes are used, they shall be asphalt coated and dipped or sufficient data shall be submitted to substantiate a 50 year service life in accordance with California Test Method No. 643.B. Culverts 24 inches in diameter or less with four feet or less of cover to flow line may be designed for a 25 year service life.
- c) Erosion Protection: (~~See see Paragraph sub paragraph~~ i also) All culverts shall have flared end sections or concrete headwalls. Erosion protection shall be provided at all culvert outlets; and at culvert inlets and outlets' where abrupt changes in ~~channel~~ alignment are ~~30~~ encountered. Typical erosion protection consists of keyed rock ~~rip-rip~~-rap surrounding sensitive areas. Erosion Protection measures shall be detailed and approved by the County Engineer. See detail ~~page-P-II-11~~ for a typical Drainline Outlet installation.
- d) Abrasion Protection: Paved inverts are required for metal pipe culverts when the velocity in the channel is 5 feet per second or more.

- e) Minimum Cover: The minimum cover over pipes installed within the road right of way shall be as required for pipe strength, loading conditions, and hydraulic requirements.
- f) Runoff computations: Figure 7-811.6 of the State Planning Manual on Page [24-43](#) is generally acceptable for computing runoff in rural areas. Additional field information and possible revised criteria should be developed for culverts or systems requiring 66 inch diameter or larger pipe. A tabular chart for each drainage basin incorporating elevation of most remote point of the water-shed above the point of concentration, length of the channel from the most remote point to the point of concentration, intensity, area of the tributary basin, percentage of runoff, design discharge for 100 year and 10 year runoff ($Q_{10} = (2/3) Q_{100}$) and velocities should be submitted with proposed improvement plans or made a part of the improvement plans. In rural areas, runoff factors can be determined by summing up the values shown on Figure (3). The minimum time of concentration shall be 10 minutes for any drainage basin. For developed areas or areas that have a potential for future development, Figure 3.1 will give runoff factors.
- g) Design Capacity: Culverts shall be designed to pass a ten year runoff without head on the inlet under free outfall conditions, and a hundred year ~~runoff~~ runoff with a head not higher than the nearest edge of the traveled way. Entrance capacity for the ten year runoff will generally control culvert design. Comprehensive drainage systems shall be designed to carry a ten year runoff without head and a 100 year runoff using the head available in the appurtenant structures. Figure (4) gives the critical capacities of the most common pipe sizes.
The following exceptions are allowed for Low Density Common Drives.
 - (1) In flood hazard areas as designated on the FIRM map, culverts shall be sized to the 10 year runoff without head and assuming no adjacent inundation.
 - (2) In the remaining areas culverts shall either meet the requirements set forth (g): or pass a runoff equal to the capacity of the upstream channel, and together with the road being designed for this purpose, convey the 100 year runoff without damage to the road.
 In either case 1 or 2 the minimum pipe size shall be 18 inch.
- h) Curbs and Gutters: Curbs and gutters shall be designed to carry a hundred year runoff without overtopping the curb or the back of sidewalk. Generally, drainage water in gutters will not be allowed to travel more than 1,000 feet.
- i) Roadside Ditches: Roadside ditches, where allowed, shall be designed to carry ten year runoff with six inches of freeboard. The minimum slope shall be 0.25% and paving or rock-lining will be required when the velocity would cause erosion in an unpaved ditch. Roadside ditches generally will not be allowed in areas that are to be developed into lots unless the area is very remote and the lots are unusually

large. Permissible velocities for unlined ditches and channels are given in Figure (5).

- j) Channels: Channels may be used in place of pipe when the required pipe size would be larger than 48 inches in diameter. Existing natural channels and creeks may remain unimproved in built up areas if the flow of water is continuous throughout the year and if the channel or creek is adequate to carry a hundred year runoff with one foot of freeboard or more and with minimal backflow effect. Existing inadequate creeks and channels shall be improved as required to obtain capacity to carry a hundred year runoff with one foot of freeboard within the boundaries of the area to be developed. The design of large channels shall also be reviewed and approved by the Napa County Flood Control District. Natural ravines and swales in Type II and or low density areas may remain undisturbed if it is determined that this would not create drainage or erosion problems.
- k) Bridges: Bridges shall be designed to pass a hundred year runoff with a minimum of two feet of freeboard. Streams which carry large floating debris may require greater freeboard at bridge sites. Abutments shall be protected from erosion damage which may necessitate use of rip-rap or other suitable material and methods. Abutments on fill material will not be allowed unless supported on piles and the fill is adequately protected from erosion. Piers in the waterway area shall have no opening. Bridges shall generally conform to ~~CALTRANS~~ standards and guidelines [of the California Department of Transportation](#).
- l) Outfall Requirements: Drainage water originating within or passing through a subdivision shall be disposed of in a natural watercourse, which may require work outside of the subdivision boundary. A watercourse is defined as: a running ~~stream~~¹-stream of water; a natural stream, including rivers, creeks, runs, and rivulets. There must be a stream usually flowing in a particular direction, though it need not flow continually. It may sometimes be dry. It must flow in a definite channel, having a bed, sides, or banks; it must be something more than a mere surface drainage over the entire face of a tract of land, occasioned by unusual freshets or other extraordinary causes. It does not include the water flowing in the hollows or ravines of land, which is the mere surface from rain and is discharged through them from a higher to a lower level, but which at other times are destitute of water. Such hollows or ravines are not watercourses. Special attention must be given to drainage in hill areas because of the potential for erosion damage and maintenance problems. Overbank storm drain outlets shall provide adequate slope protection and erosion control measures as directed by the County Engineer. Typical protection measures include placement of rock rip rap or

a concrete pad to ~~capture~~ capture the culvert out fall drainage and discharge it safely at the base of the slope. See detail P-1711.

Miscellaneous Design Criteria: Loss of head through structures shall be calculated using standard engineering methods and equations. Roughness factors for use in design shall be as follows:

1. Concrete pipe over 36" diameter _____ 0.013
2. Concrete pipe less than 36" _____ 0.015
3. Corrugated Metal Pipe _____ 0.021
4. CMP with paved invert _____ 0.019
5. Smooth walled HDPE Pipe _____ 0.012

Formatted: Tab stops: 4", Left

Example:

A culvert site in the Imperial Valley is 3 miles downstream and 900 ft. lower than the most remote point on the watershed. The tributary basin has an area of 2.0 square miles and average ratio of runoff to precipitation is estimated at 60 percent. The time through H = 900 ft., L = 3 mi., G = 0, A = 2 sq. mi. and K = 60 intersects Q = 1700 second-foot the required design discharge.

Incidentally, the flow results from a 41 minute storm of 2.2 inches per hour.

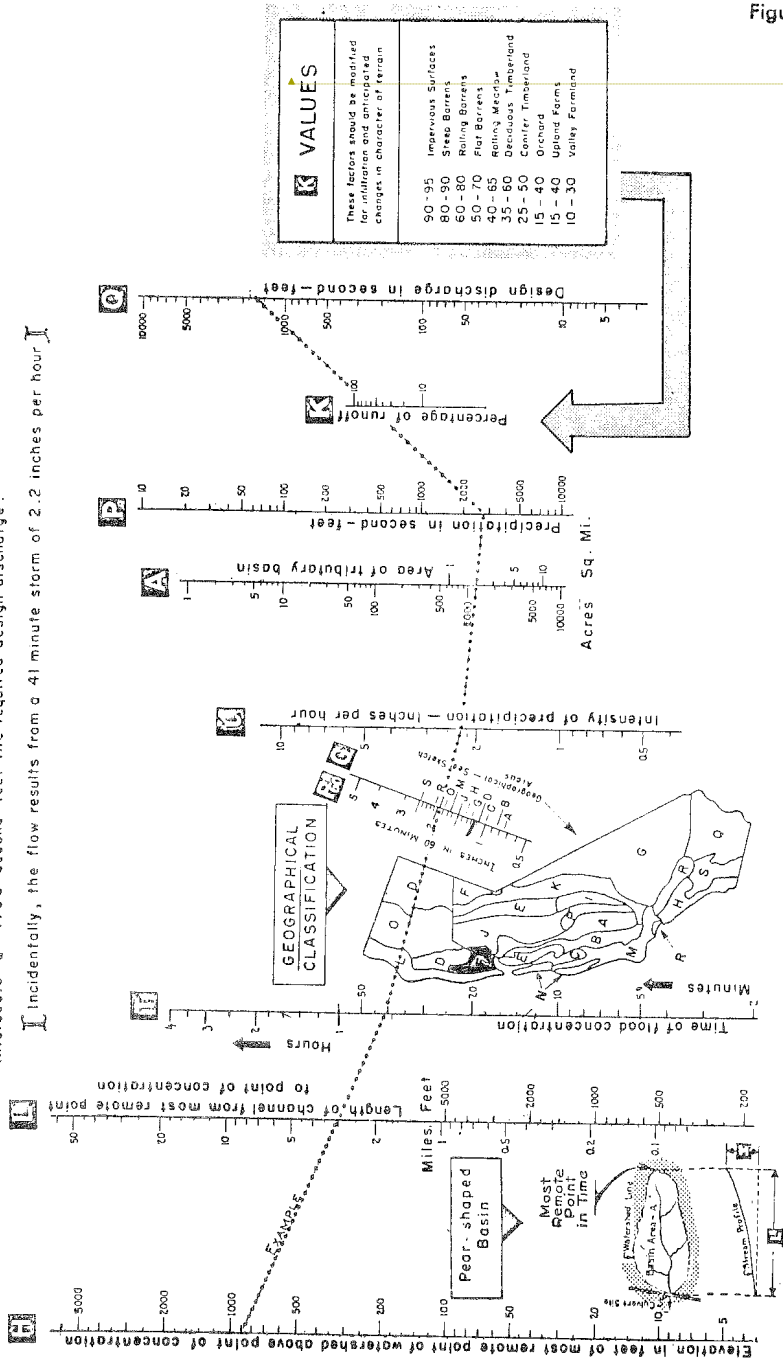

Figure 7-811.6
August, 1964

Formatted: Font: Palatino Linotype, 11.5 pt

DESIGN DISCHARGE FOR SMALL BASINS

FIGURE 3

Formatted: Font: Palatino Linotype, 12 pt

Formatted: Font: 12 pt

Formatted: Adjust space between Latin and Asian text, Adjust space between Asian text and numbers

RUNOFF COEFFICIENT FOR DEVELOPED AREAS

-Chart

Type of Development	Coefficient	
	<i>Mild Slope</i>	<i>Steep Slope</i>
Low Density Residential 1-3 Units/Acre	0.40	0.60
Medium Density Residential 4-9 Units/Acre	0.45	0.65
High Density Residential 10 or more Units/Acre	0.60	0.75
Limited Industrial	0.60	0.80
Industrial	0.75	0.90
Commercial	0.80	0.90
Schools	0.45	0.65
Parks	0.25	0.50

FIGURE 3.1 {Insert Chart}

Formatted: Font: 14 pt

Formatted: Normal, Left

Formatted: Font: 14 pt, Bold

Formatted Table

Formatted: Font: 12 pt, Italic

Formatted: Font: (Default) Arial, 11 pt

Formatted: Font: (Default) Arial, 11 pt

Formatted: Left

Formatted: Font: (Default) Arial

Formatted: Font: (Default) Arial

Formatted: Font: (Default) Arial

Formatted: Font: (Default) Arial

Formatted: Font: (Default) Arial, 11 pt

Formatted: Left

Formatted: Font: (Default) Arial, 11 pt

Formatted: Font: (Default) Arial, 11 pt

Formatted: Font: (Default) Arial, 11 pt

Formatted: Left

Formatted: Font: (Default) Arial, 11 pt

Formatted: Font: (Default) Arial, 11 pt

Formatted: Font: (Default) Arial, 11 pt

Formatted: Left

Formatted: Font: (Default) Arial, 11 pt

Formatted: Font: (Default) Arial, 11 pt

Formatted: Font: (Default) Arial, 11 pt

Formatted: Left

Formatted: Font: (Default) Arial, 11 pt

Formatted: Font: (Default) Arial, 11 pt

Formatted: Font: (Default) Arial, 11 pt

Formatted: Left

Formatted: Font: (Default) Arial, 11 pt

Formatted: Font: (Default) Arial, 11 pt

Formatted: Font: (Default) Arial, 11 pt

Formatted: Left

Formatted: Font: (Default) Arial, 11 pt

Formatted: Font: (Default) Arial, 11 pt

Formatted: Font: (Default) Arial, 11 pt

Formatted: Left

Formatted: Font: (Default) Arial, 11 pt

Formatted: Font: (Default) Arial, 11 pt

Formatted: Font: (Default) Arial, 11 pt

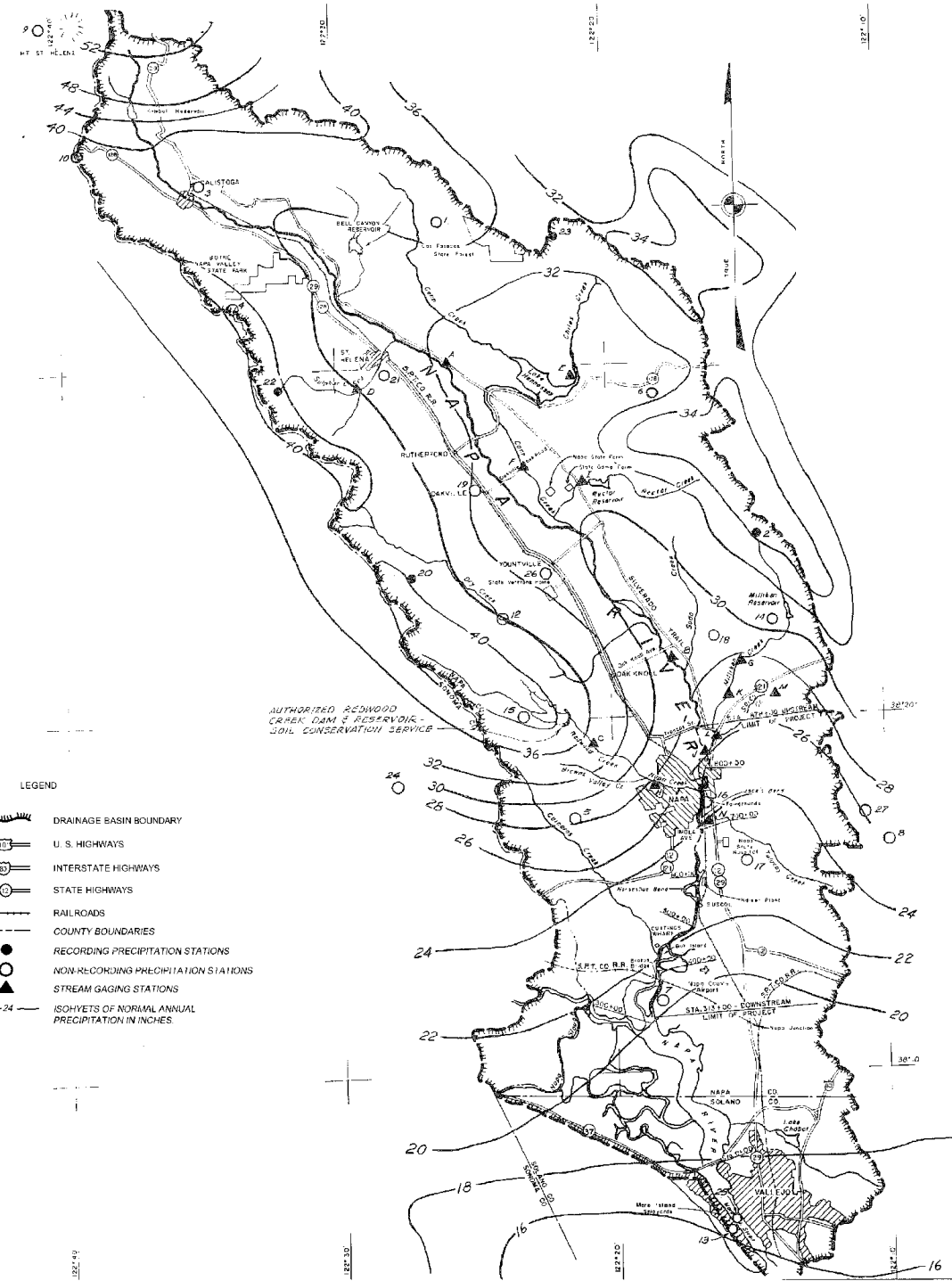

- LEGEND**
- DRAINAGE BASIN BOUNDARY
 - U. S. HIGHWAYS
 - INTERSTATE HIGHWAYS
 - STATE HIGHWAYS
 - RAILROADS
 - COUNTY BOUNDARIES
 - RECORDING PRECIPITATION STATIONS
 - NON-RECORDING PRECIPITATION STATIONS
 - STREAM GAGING STATIONS
 - ISOHYETS OF NORMAL ANNUAL PRECIPITATION IN INCHES

PRECIPITATION CHART
LOWER COUNTY

FLOOD CONTROL
GENERAL DESIGN MEMORANDUM
NAPA RIVER CHANNEL IMPROVEMENTS
NAPA COUNTY, CALIFORNIA
HYDROLOGY AND HYDRAULIC ANALYSIS
NORMAL ANNUAL PRECIPITATION AND
HYDROLOGIC INDEX MAP
U.S. ARMY ENGINEER DISTRICT, SAN FRANCISCO, CORPS OF
ENGINEERS

TO ACCOMPANY REPORT, FILE NO. **50-47-1**
 DATED 12 March 75

Formatted: Font: (Default) Palatino Linotype, 12 pt, Bold, Small caps
Formatted: Left: 1", Right: 0.5", Top: 0.7", Bottom: 0.5"

- Formatted:** Font: Palatino Linotype, 14 pt, Bold, Small caps
- Formatted:** Centered
- Formatted:** Font: Palatino Linotype, 14 pt, Bold, Small caps
- Formatted:** Font: 8 pt
- Formatted:** Centered
- Formatted:** Font: 10 pt
- Formatted:** Font: 10 pt
- Formatted:** Font: 7 pt
- Formatted:** Font: 9 pt
- Formatted:** Font: 8 pt
- Formatted:** Font: 8 pt
- Formatted:** Font: 6 pt
- Formatted:** Centered
- Formatted:** Font: 6 pt
- Formatted:** Font: 6 pt
- Formatted:** Font: 10 pt, Bold

PRECIPITATION CHART

UPPER COUNTY

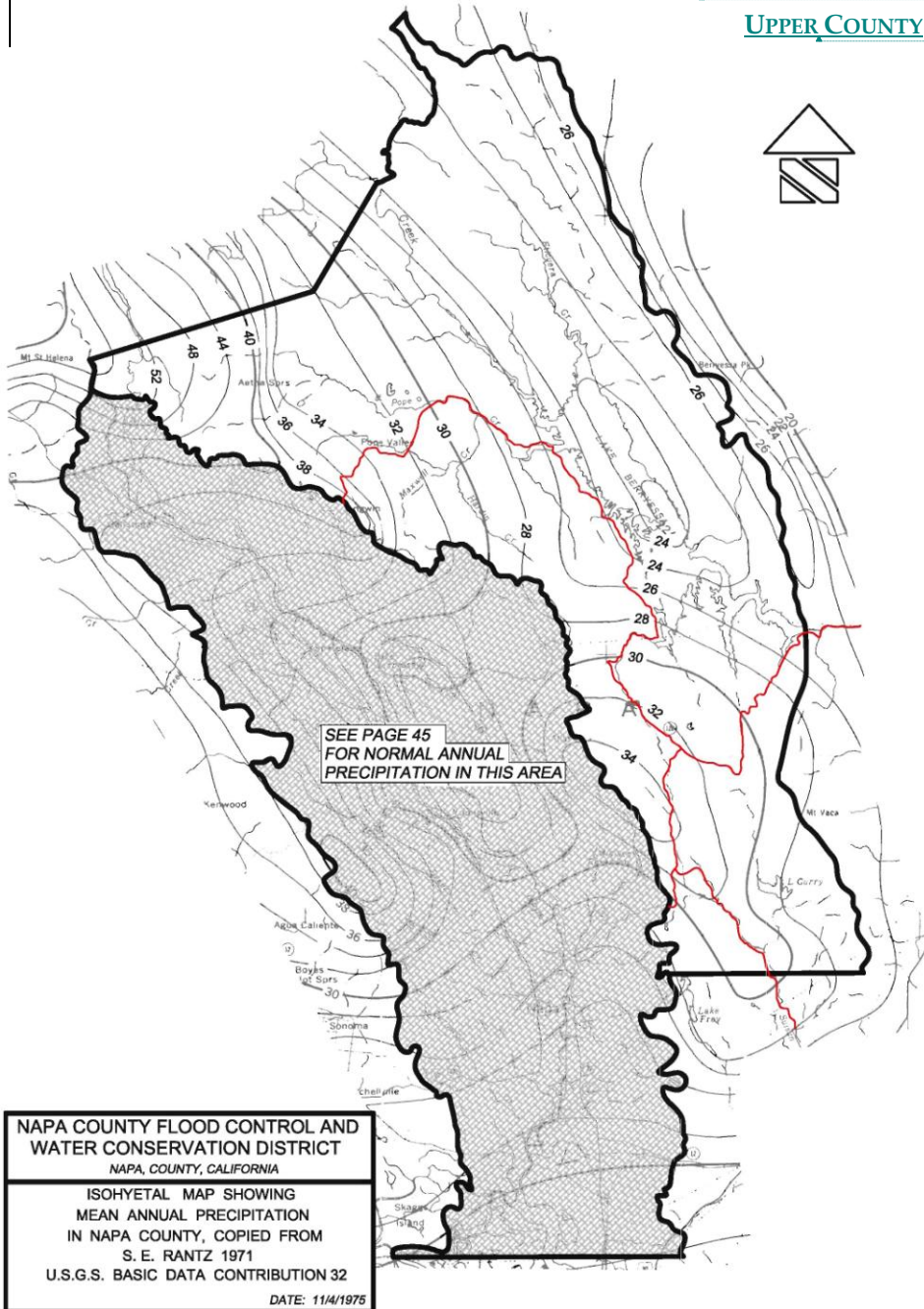

NAPA COUNTY FLOOD CONTROL AND
WATER CONSERVATION DISTRICT
NAPA COUNTY, CALIFORNIA
ISOHYETAL MAP SHOWING
MEAN ANNUAL PRECIPITATION
IN NAPA COUNTY, COPIED FROM
S. E. RANTZ 1971
U.S.G.S. BASIC DATA CONTRIBUTION 32
DATE: 11/4/1975

- Formatted:** Font: Palatino Linotype, 14 pt, Bold, Small caps
- Formatted:** Centered
- Formatted:** Right: 0.7", Bottom: 0.88"
- Formatted:** Font: Palatino Linotype, 14 pt, Bold, Small caps
- Formatted:** Normal, Left
- Formatted:** Left, Adjust space between Latin and Asian text, Adjust space between Asian text and numbers

- Formatted:** Font: Palatino Linotype, 14 pt, Bold, Small caps
- Formatted:** Centered
- Formatted:** Font: Palatino Linotype, 14 pt, Bold, Small caps

MEAN ANNUAL PRECIPITATION CHART VS. 60 MINUTE RAINFALL

Insert Chart

Formatted: Font: (Default) Palatino Linotype, 16 pt, Bold, Small caps

Formatted: Font: Palatino Linotype, 11.5 pt

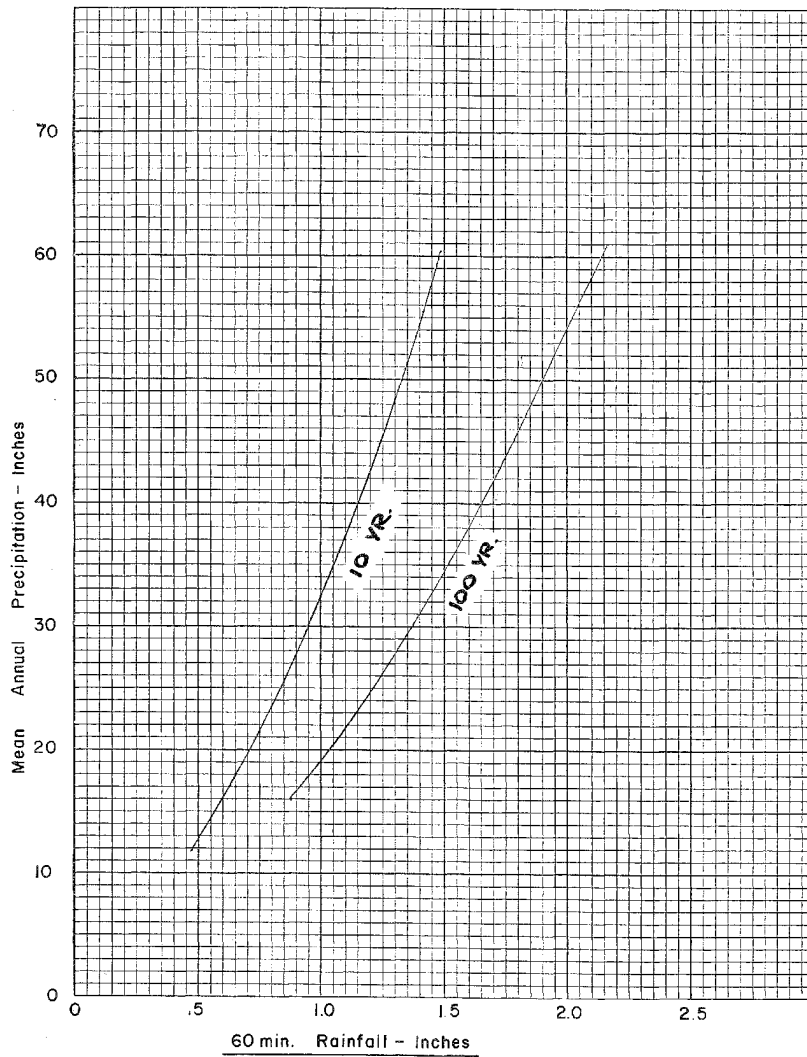

INTENSITY - DURATION CHART

[Insert Chart]

Formatted: Font: (Default) Palatino Linotype, 16 pt, Bold, Small caps

Formatted: Font: (Default) Palatino Linotype, 16 pt, Bold, Small caps

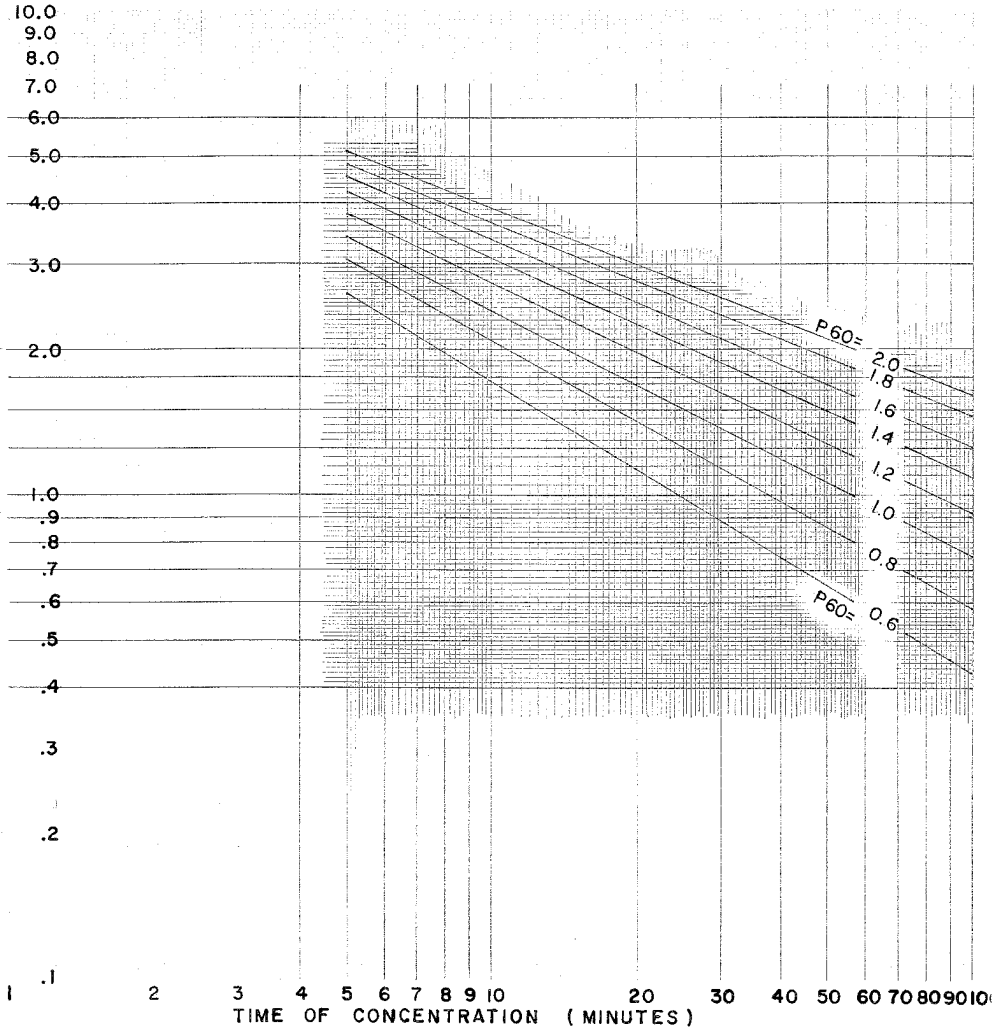

Based on figure 7-811.6 (-8-64)
State of California
Division of Highways
Planning Manual

NOMOGRAPH CHART

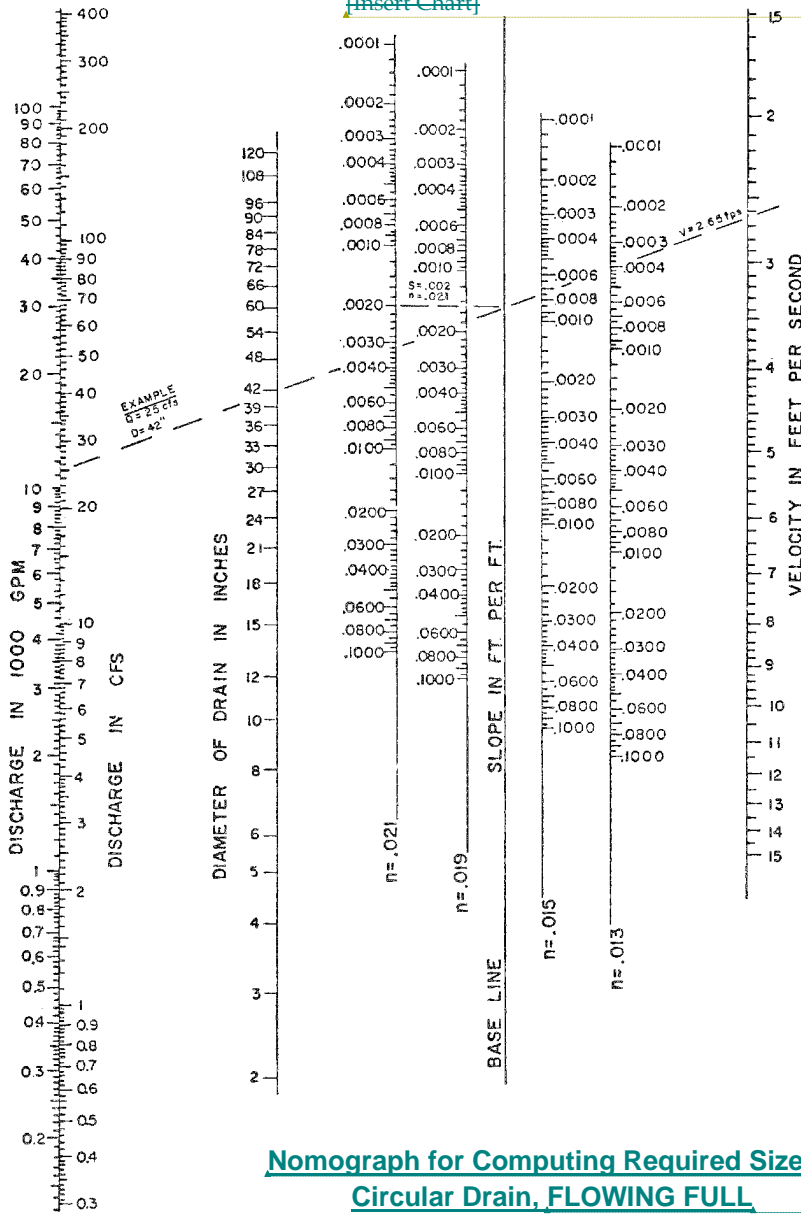

[Insert Chart]

Formatted: Font: Palatino Linotype, 11.5 pt

Nomograph for Computing Required Size of Circular Drain, FLOWING FULL

$n = 0.013$ $n = 0.015$
 $n = 0.019$ $n = 0.021$

Formatted: Font: BankGothic Lt BT, 14 pt, Bold

Formatted: Centered

Formatted: Font: BankGothic Lt BT, 14 pt, Bold, Underline

Formatted: Font: BankGothic Lt BT, 14 pt, Bold

Formatted: Font: Palatino Linotype, 12 pt, Bold

22-23. PLANNED UNIT DEVELOPMENT AND OTHER TYPES

Developments other than the normal single family residential and recreational subdivisions will be improved with facilities that are consistent with the objectives and criteria in the preceding pages. Specific design elements will be determined by the County Engineer on an individual basis.

23-24. ASSESSMENT DISTRICTS

Improvement requirements for assessment districts are the same as for privately financed developments. However, before an assessment district can be formed, the developer must comply with the requirements of the County's assessment district policy: Dated 1966 - 1990.

1. Purpose of Policy

(a) To facilitate the acquisition and construction of public facilities in those portions of the County designated on the Napa County General Plan as suitable for commercial or industrial uses if needed to promote any of the following:

- 1) The health and welfare of the developed areas;
- 2) The promotion of the orderly development of the County;
- 3) The development of needed commercial or industrial property;

(b) Residential improvements shall not be eligible for assessment financing.

2. Policy considerations regarding the need for an assessment district

Factors to be considered in reviewing a request that a special assessment district be formed shall include but not be limited to the following:

- (a) Is there a need for the development of additional commercial and industrial zoned lots in the community?
- (b) Is the inventory of existing improved parcels that are in the community adequate?
- (c) Will the proposed assessment, when added to the existing public indebtedness in the area to be assessed, result in an unusually high tax rate or collection charge being assessed which will tend to make the sale or use of the property uneconomic?
- (d) Does the County anticipate debt issuance during the applicable calendar year for purposes of general County operations, which, in the absence of any assessment district debt authorization, would make total County debt issuance eligible for the applicable small issuer arbitrage exemption rule?

3. Facilities eligible for funding through assessment financing

Facilities the construction of which may be financed through assessment proceedings are limited to public facilities located within dedicated rights-of-way or easements which the County or other local agency will be required to maintain and operate. The types of facilities to be financed are:

- (a) Streets;
- (b) Drainage facilities;
- (c) Public utilities, whether privately or publicly owned, which are appurtenant and incidental to streets or which otherwise provide significant public benefit if not appurtenant or incidental to streets; and
- (d) Landscaping when used in conjunction with other public improvements listed above.

The above extract is included so as to provide an outline of the County's position. Full copies of the policy may be obtained from the Clerk of the Board of Supervisors.

24-25. PARCEL MAP IMPROVEMENTS - RESIDENTIAL DEVELOPMENT

Divisions of land by Parcel Map fall into three (3) general categories: (1) those adjacent to a county road, (2) on an existing private road, and (3) on a proposed new road which may be private or public. Road improvement requirements are as follows:

Case I – Adjacent to County Road

<u>Parcel Size</u>	<u>Improvement</u>
0 to less than ¾ acre	full improvements including curb, gutter and sidewalk as required for particular road and right of way dedication.
¾ to 2 acres	<ol style="list-style-type: none"> 1. Widen existing road to provide a minimum 60' long parking lane per lot exclusive of driveways, or 2. Provide improved all weather surface in parking areas in accordance with County Standards for four cars per lot in addition to garage and carport, or 3. Provide 60 foot building setback from right of way line.

A statement shall be placed on a document recorded concurrently with the Parcel Map explaining the parking options and also clearly indicating that one of the three options must be provided before or at the time that a building permit is finalized. On parcels already improved with dwellings, the parking requirements must be met prior to recordation of the final Parcel Map.

More than 2 acres to 200 acres Right of way dedication

Case II – On Existing Private Roads

The portion of the existing private road fronting or crossing the proposed parcels shall be improved to the appropriate subdivision road standard as determined by the County Engineer.

That portion of the private road between the subject parcel and the County Road shall be improved to meet the requirements of a Common Drive Low Density. Parking shall be as required for Case I.

Case III – New Roads

Parcel map divisions on new roads, public or private, shall be served by roads constructed to the appropriate subdivision standard. New roads that do not connect to an existing publicly maintained road system will not be accepted into the County Road System. Parking shall be as required for Case I.

25-26. PARCEL MAP IMPROVEMENTS - COMMERCIAL AND INDUSTRIAL DEVELOPMENT

Road and drainage improvements shall be constructed to ultimate status for all parcel map divisions in areas zoned industrial or commercial.

26-27. SPECIFICATIONS

The following specifications shall apply to all developments, public or private.

ROAD AND STREETS

Street and road work shall conform to approved Plans and Profiles, the County of Napa Standard typical sections, these special requirements, and ~~the applicable provisions of the "State of California, Department of Transportation, Division of Highways, Standard Specifications in latest edition~~ Caltrans Standard Specs," except that all Portland Cement Concrete shall be "Class B," with 1 ½ inch maximum aggregate.

Roadway excavation shall be in accordance with Section 19-2 of ~~said Standard Specifications~~ Caltrans Standard Specs, except that sub-grade excavation below the grading plane as specified in Section 19-5.02-03 will not be required. When the original ground below the grading plane and within 2 ½ feet of finished grade has a relative compaction of less than 95 percent, the 0.5 foot of ~~base~~ ment material below said grading plane shall be compacted until not less than 95 percent relative compaction is obtained.

Embankment construction shall conform to Section 19-6 of ~~said Standard Specifications~~ Caltrans Standard Specs, except that sub-grade excavation or original ground below the grading plane as specified in Section 19-5.02-03 will not be required. Original ground within 2 ½ feet of finished grade shall be compacted as specified above for excavation areas.

The laying of the aggregate base shall not commence until: All of the utility lines, including mains and service connections for water, ~~recycled water,~~ gas, ~~electrical,~~ cable or telephone conduit, ~~sanitary sewers and storm drains~~ are installed in the streets; all service connections

Formatted: Underline

Formatted: Heading 2, Adjust space between Latin and Asian text, Adjust space between Asian text and numbers

made beyond the graded section backfilling completed in accordance with the hereinafter specified requirements; and the County Engineer has approved the subbase in writing.

Aggregate base material and the placing thereof shall conform to Section 26 of ~~said Standard Specifications~~Caltrans Standard Specs. Aggregate base material shall be "Class 2 Aggregate Base," 1 1/2 inch maximum size, or 3/4 inch maximum as specified in ~~Section 26~~Caltrans Standard Specs. Subbase material shall be Class 2 in accordance with Section 25 of ~~the Standard Specifications~~Caltrans Standard Specs.

A prime coat treatment shall be applied to the finished surfaces of the aggregate base prior to placement of the ~~asphalt concrete~~HMA in accordance with the provisions of Section 39 of said ~~Standard Specifications~~Caltrans Standard Specs. The Liquid Asphalt used for penetration treatment conform to the requirements of Section 93 of ~~said Standard Specifications~~Caltrans Standard Specs, as modified, and the total amount to be applied will be determined by the County Engineer or his authorized representative.

~~Asphalt concrete~~HMA shall be Type B conforming to Section 39-2 of ~~said Standard Specifications~~Caltrans Standard Specs. Asphalt binder to be mixed with ~~the mineral~~ aggregate shall be ~~Paving Asphalt AR 4000 penetration~~a steam-refined paving asphalt conforming to performance grading PG 64-10 in accordance with, ~~and shall conform to~~ Section 92 of ~~said Standard Specifications~~Caltrans Standard Specs.

Napa County standard barricade(s) shall be constructed at the end of all stub streets, and at any other locations as shown on the plans.

UTILITIES

All mains and service connections for all utility facilities to be installed in the street area shall be laid to the line and grade shown on the plans or to the line and grade as established by the County Engineer of the County of Napa. In no case shall any utility facility be installed in the street area less than 30 inches below finish grade, except storm drain facilities, where approved.

Excavation and backfill for all pipe lines within the roadway section, including mains and service connections for water, ~~gas,~~ electrical, ~~cable~~ -or telephone conduit, ~~sanitary sewer~~ and storm drains shall conform to Section 19-3 of ~~said Standard Specifications~~Caltrans Standard Specs except as modified herein. The trench shall be filled to one (1) foot above the top of the facility with imported fine material, readily compactable around and under the facility; conforming to Section 19-3.06 of ~~the Standard Specifications~~Caltrans Standard Specs or equivalent approved by the County Engineer. The remainder of the trench shall be backfilled by one of the following methods.

1. If a granular backfill material is used for backfilling the remainder of the trench (minimum sand equivalent 30), compaction may be accomplished by adding sufficient water to the material as it is placed in the trench to achieve consolidation and a relative compaction of not less than 90 percent up to ~~2-1/2~~ 2.7 feet below finish

Formatted: Underline

Formatted: Heading 2, Adjust space between Latin and Asian text, Adjust space between Asian text and numbers

grade, and 95 percent within 2 ½ feet of finish. If the trench is in solid rock, the backfill shall be compacted to 95 percent relative compaction the entire depth of the trench. The backfill material shall be placed and compacted in layers not exceeding four (4) feet in thickness and vibratory or other compaction equipment shall be used whenever necessary to obtain the required compaction. Ponding or use of excessive amounts of water will not be permitted however, and permission from the County Engineer or his authorized representative must be obtained before these methods of compaction will be allowed.

2. The use of material from the excavation for structure backfill will be allowed providing that the relative compaction is 90 percent up to 2 ½ feet below finish grade and 95 percent within 2 ½ feet of finish grade. If the trench is in rock, the backfill shall be compacted to 95 percent relative compaction the entire depth of the trench. The backfill material shall be placed in horizontal, uniform layers not exceeding eight (8) inches in thickness before compaction, and shall be brought up uniformly on all sides of the facility and the trench. Compaction must be accomplished by mechanical methods only. No ponding, jetting or use of excessive amounts of water will be allowed.

DRAINAGE

Drainage provisions and structures shall be installed in accordance with the approved Plans and Profiles, the County of Napa typical sections and applicable provisions of ~~the CALTRANS Standard Specifications~~Caltrans Standard Specs.

In lieu of reinforced concrete pipe, storm drains may be installed outside of the street areas as shown on the approved Plans and Profiles. All such storm drains shall conform to ~~the CALTRANS Standard Specifications~~Caltrans Standard Specs.

Sacked Portland Cement Concrete or Light Stone Rip-Rap conforming to Section 72 of ~~said Standard Specifications~~Caltrans Standard Specs shall be placed at the locations indicated on the approved Plans and Profiles or at the locations specified by the County Engineer or his authorized representative. Sufficient rip-rap shall be placed at each location to insure adequate protection for the facilities involved.

MONUMENTS

Napa County Standard Street Monuments consisting of cast-in-place "Class A" Portland Cement Concrete, six (6) inches in diameter, thirty-six (36) inches in depth, twelve and one quarter (12 ¼) inches below grade and covered with a standard cast iron monument cover, shall be installed in the streets as shown on the approved Plans and Profiles.

Formatted: Underline

Formatted: Heading 2, Adjust space between Latin and Asian text, Adjust space between Asian text and numbers

Formatted: Underline

Formatted: Heading 2, Adjust space between Latin and Asian text, Adjust space between Asian text and numbers

The monuments shall have the exact point marked by cross on a brass disk bearing the license number of the Engineer or Surveyor making the survey. The copper plate shall be flush with the top of the monument and securely fastened by a copper rod or dowel, extending not less than three (3) inches into the concrete.

In lieu of the above type monument, on the exterior boundary angle and curve points not in the street area, the following type monuments will be allowed: A three quarter (3/4) inch minimum interior diameter galvanized pipe at least three (3) feet long projecting one (1) inch above ground, filled with mortar, and with the exact point marked on a tag to be permanently set in the mortar by means of a dowel extending not less than two (2) inches into the mortar, or a three quarter (3/4) by three quarter (3/4) inch steel T-bar at least three (3) feet long projecting one (1) inch above ground, treated with a corrosion resisting coating and fitted with a one (1) inch minimum diameter brass cap attached to the stake by means of a drive screw.

Following the setting of all monuments and the completion of all other improvements required hereunder, the street monuments and exterior boundary monuments may be field checked and the measurements obtained will be compared with the dimensions shown on the Parcel Map or Final Map. Any discovered errors in excess of the allowable error as specified in the Napa County standards shall be corrected prior to the acceptance of the subdivision improvements by the County of Napa. After discovered errors have been corrected, the County will make one re-check at no cost. Any additional checks required by the County will be at the expense of the Subdivider or Developer, and a cash deposit for the monument checking will be posted with the County prior to field work by County Crews.

General

The subdivider shall notify the County Engineer of the County of Napa, in writing at least three (3) days in advance of the commencement of any part of the work. In addition, the Subdivider's contractor and subcontractor shall contact the County Engineer's office to arrange a pre-project conference for the purpose of reviewing job requirements and County procedures. It is the Subdivider's responsibility to supply the contractor with a copy of this document prior to construction. Upon completion of all work, including the setting of all monuments, the Subdivider shall request a final inspection in writing.

No variation in the corrected and approved Plans, Conditions, Specifications and Provisions will be allowed without first obtaining approval for each variation from the County Engineer. Any request for variation shall be submitted in writing to the County Engineer. No work shall be done on the portion of the work on which the variation is requested until written approval is obtained from the County Engineer.

27. PERMITS

The Department of Public Works shall, upon request of the County agencies and departments, make comments and recommendations in response to various applications and

Formatted: Heading 2

permit requests. The Department shall review such applications for the same purposes and in the same manner as a subdivision and shall liken the anticipated traffic generation of the requested facility to a subdivision and at the discretion of the ~~Director of Public Works~~County Engineer make recommendations consistent with the subdivision road and street standards.

STANDARD DETAILS

P-1 ON LOT PARKING DETAIL

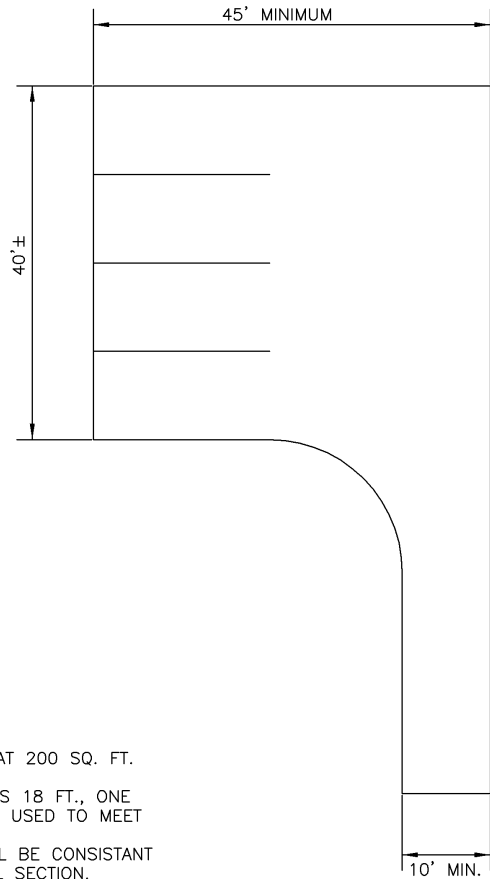

NOTE:

1. 2 TO 4 SPACES PER LOT AT 200 SQ. FT. PER SPACE.
2. IF DRIVEWAY WIDTH EXCEEDS 18 FT., ONE HALF OF DRIVEWAY MAY BE USED TO MEET PARKING REQUIREMENTS.
3. STRUCTURAL SECTION SHALL BE CONSISTANT WITH DRIVEWAY STRUCTURAL SECTION. ALTERNATE STRUCTURAL SECTION MAY BE USED UPON APPROVAL BY COUNTY ENGINEER,
4. MUST BE DUST FREE ALL WEATHER SURFACES.
5. GEOMETRIC DESIGN MAY BE VARIED.

NOT TO SCALE

COUNTY OF NAPA DEPT. OF PUBLIC WORKS	
ON LOT PARKING DETAIL (LOW DENSITY AREA)	
<i>Kenneth N. Johnson</i> COUNTY ENGINEER	RCE 17995 JAN 1999

Formatted: Centered

Formatted: Normal

Formatted: Centered

P-2 DRIVEWAY CONNECTION TO ARTERIAL ROADS – RURAL ROADS

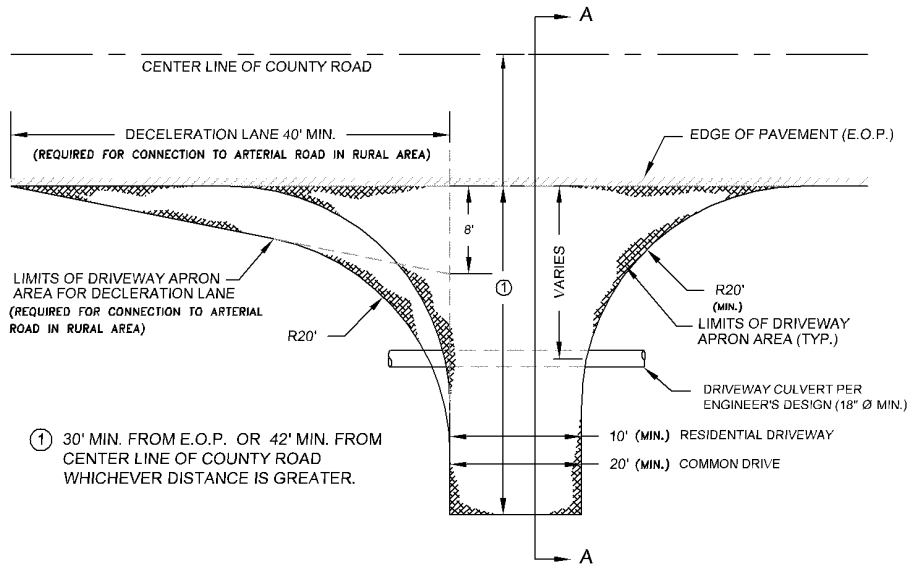

① 30' MIN. FROM E.O.P. OR 42' MIN. FROM CENTER LINE OF COUNTY ROAD WHICHEVER DISTANCE IS GREATER.

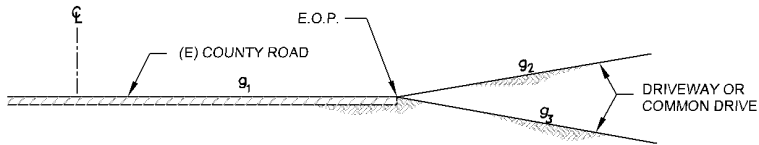

SECTION A-A

PROVIDE A 50' (MIN.) VERTICAL CURVE FOR THE FOLLOWING GRADE DIFFERENTIALS:

IF $|g_2 - g_1| > 10\%$ OR IF $|g_3 - g_1| > 6\%$

NOTES:

1. SEE DETAIL D-11 FOR ENTRY GATE DETAIL.
2. APRON AREA SHALL HAVE A MINIMUM PAVEMENT SECTION OF 2" HMA OVER 5" CL. 2 AB.
3. CULVERT MATERIAL MAY BE STEEL, ALLUMINUM, RCP, OR HDPE. MINIMUM COVER OVER CULVERT SHALL BE IN ACCORDANCE WITH THE MANUFACTURER'S SPECIFICATIONS FOR H20-44 LOADING OR AS DIRECTED BY COUNTY ENGINEER.

NOT TO SCALE

COUNTY OF NAPA DEPT. OF PUBLIC WORKS	
DRIVEWAY / COMMON DRIVE CONNECTION TO ARTERIAL ROADS IN RURAL AREAS	
<i>[Signature]</i> COUNTY ENGINEER	RCE 51790
JUNE 2011	

P-3 RESIDENTIAL DRIVEWAY AND ADJOINING SIDEWALK

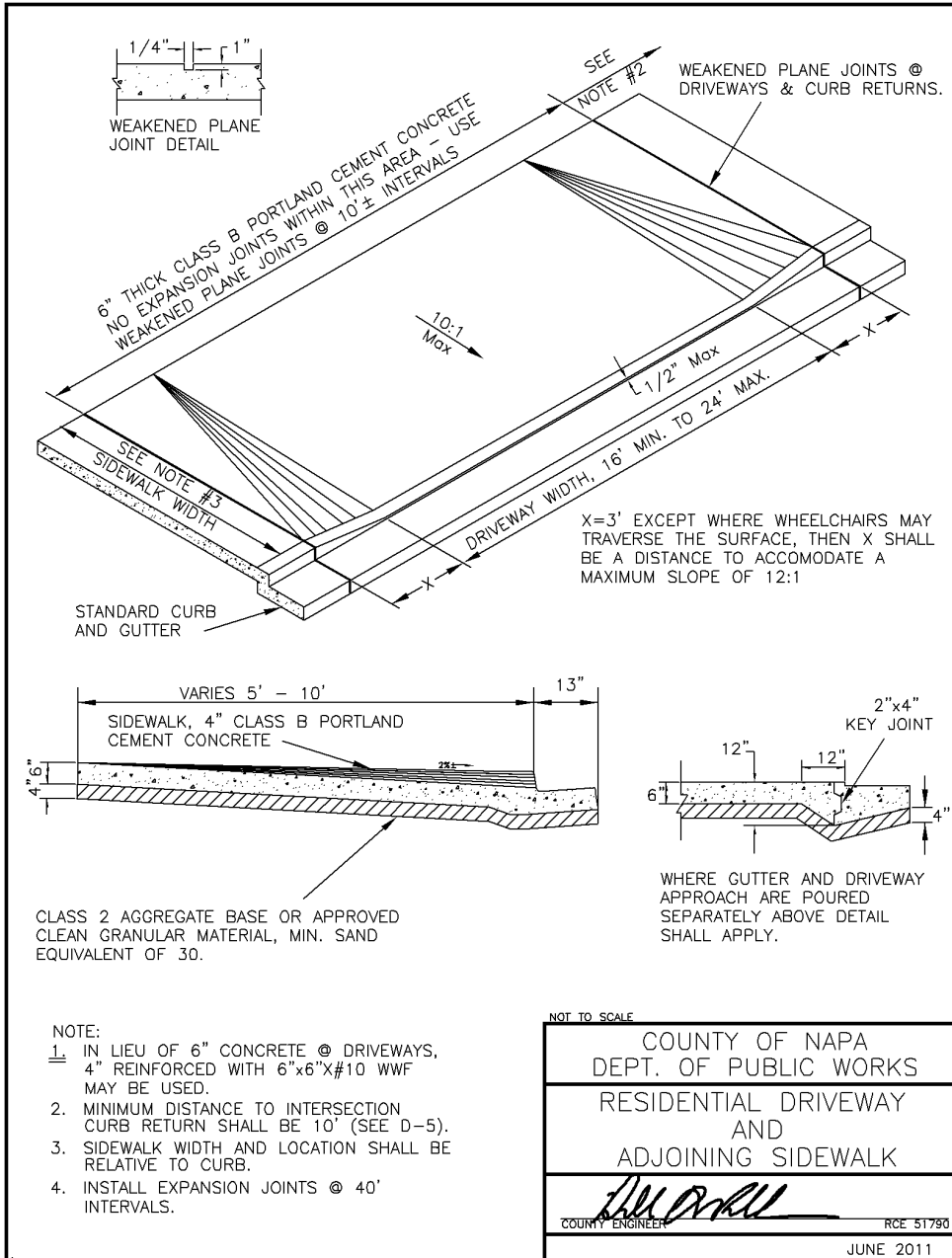

P-4 COMMERCIAL & INDUSTRIAL DRIVEWAY & ADJOINING SIDEWALK

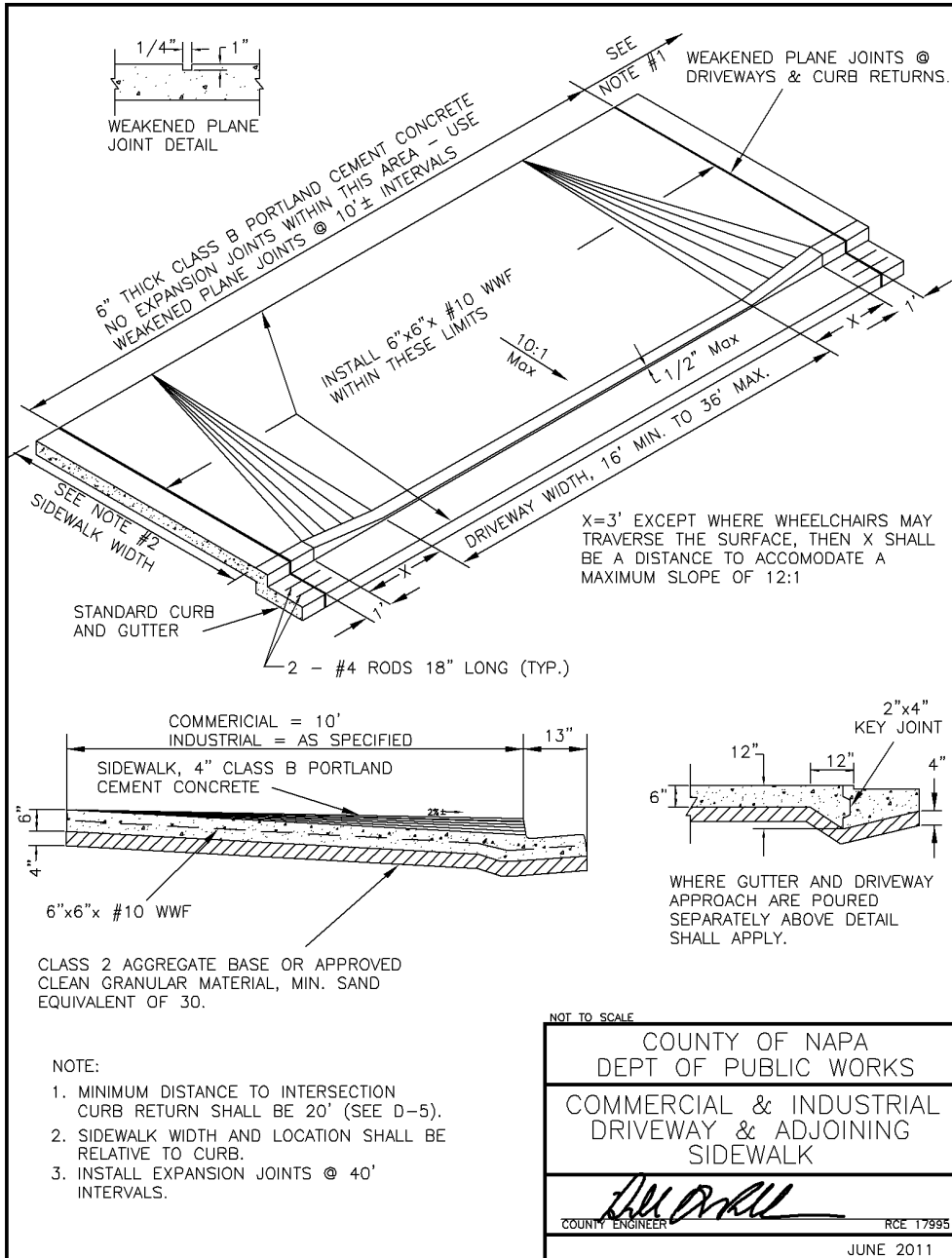

P-5 STANDARD VERTICAL CURB & GUTTER

Formatted: Centered

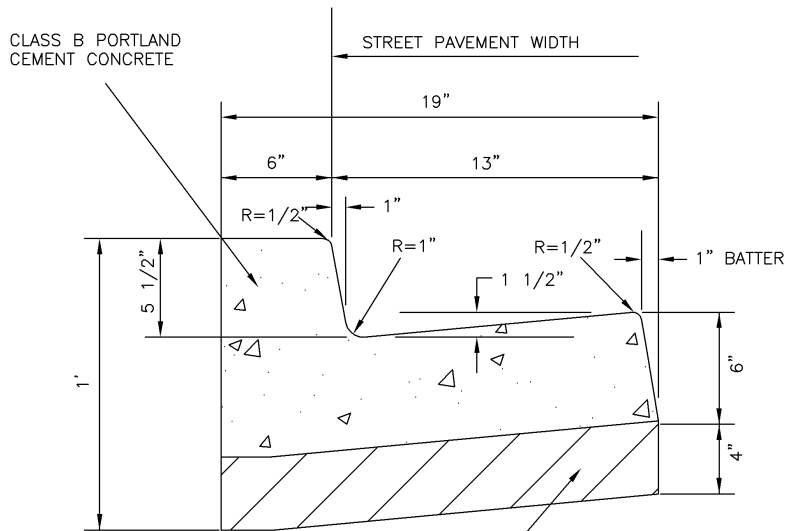

BASE FOR ALL CURBS AND MONOLITHIC CURB AND GUTTERS SHALL BE CLASS 2 AGGREGATE BASE OR APPROVED CLEAN GRANULAR MATERIAL, MIN. SAND EQUIVALENT OF 30.

NOTE:

1. INSTALL WEAKENED PLANE JOINTS @ 10' INTERVALS.
2. INSTALL EXPANSION JOINTS @ 40' INTERVALS.

NOT TO SCALE

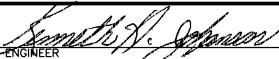
COUNTY OF NAPA DEPT OF PUBLIC WORKS	
STANDARD VERTICAL CURB AND GUTTER	
 COUNTY ENGINEER	RCE 17995
JAN 1999	

P-6 MOUNTABLE CURB

Formatted: Centered

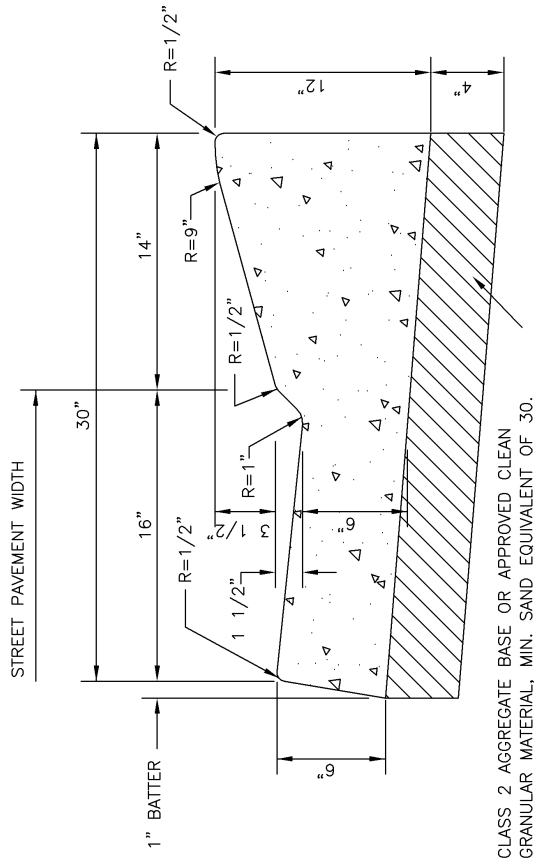
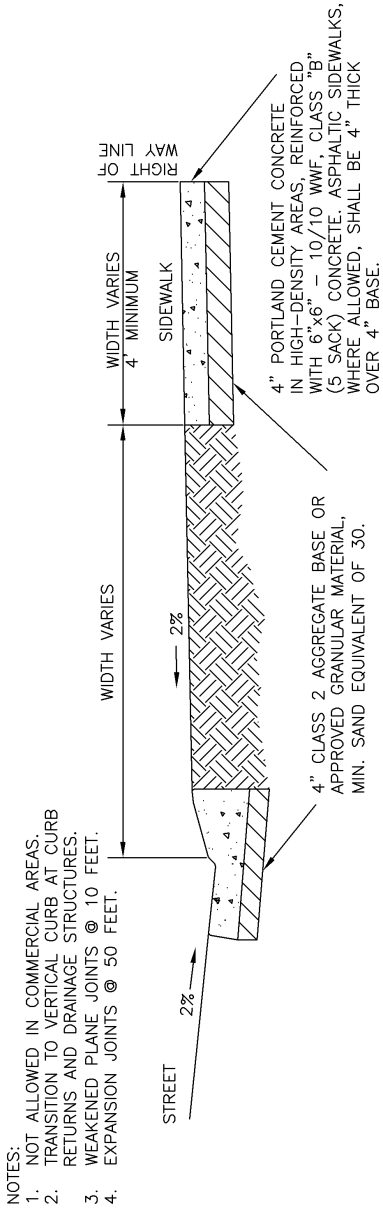

NOT TO SCALE

COUNTY OF NAPA
DEPT. OF PUBLIC WORKS

MOUNTABLE CURB

COUNTY ENGINEER *Samuel N. Johnson* RCE 17995
JAN 1999

P-7 P.C.C. CROSS GUTTER

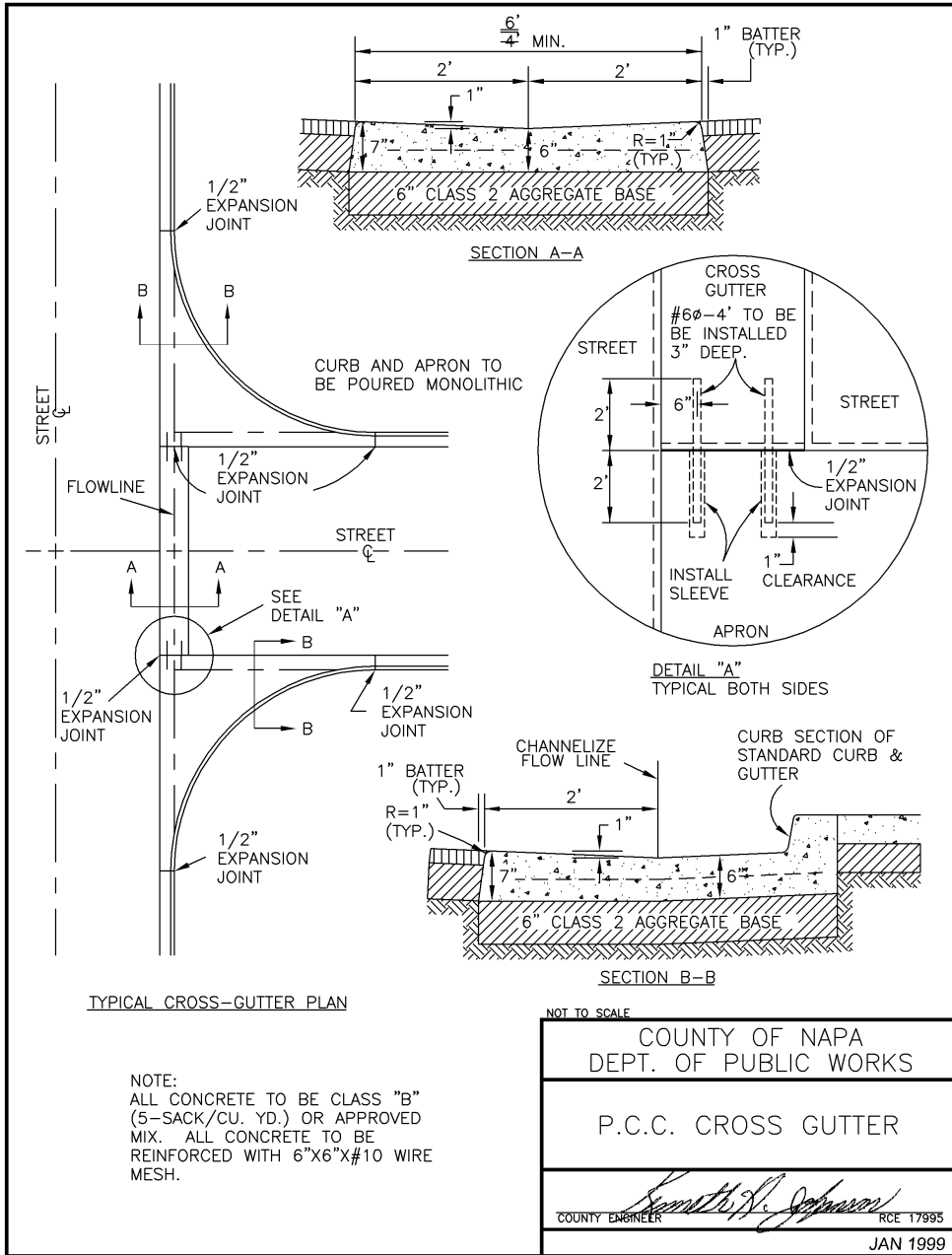

P-8 STANDARD ASPHALT DIKE

Formatted: Centered

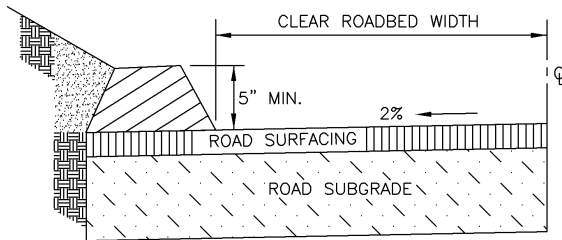
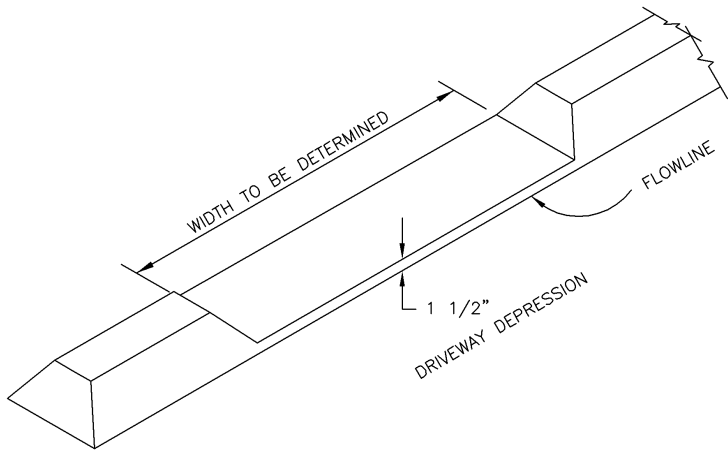

NOTE:
 DRIVEWAY APPROACHES ON DOWNHILL SIDE
 SHALL MATCH TOP OF BERM ELEVATION
 WITHIN THE ROAD RIGHT OF WAY.

NOT TO SCALE

COUNTY OF NAPA DEPT. OF PUBLIC WORKS	
STANDARD ASPHALT DIKE	
COUNTY ENGINEER <i>Samuel H. Johnson</i>	RCE 17995
JAN 1999	

P-9 TYPICAL DIKE INSTALLATION

Formatted: Centered

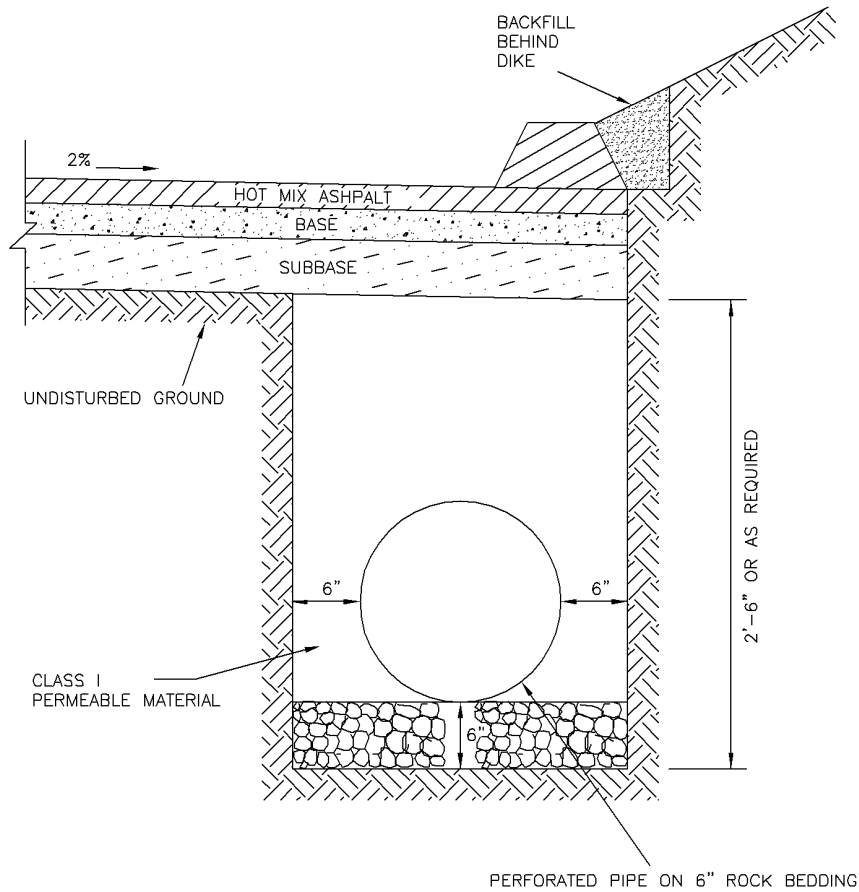

NOTE: SUBDRAINS TO BE INSTALLED AS REQUIRED BY THE COUNTY ENGINEER. TRENCH MAY BE LOCATED 2' FROM EDGE OF PAVEMENT TO FACILITATE CONSTRUCTION. ASPHALT PLUGS SHALL BE PLACED BEHIND THE DIKE AT 50' INTERVALS WHEN ROAD GRADE EXCEEDS 5% OR AS DIRECTED BY THE COUNTY ENGINEER.

NOT TO SCALE

COUNTY OF NAPA
DEPT. OF PUBLIC WORKS

TYPICAL DIKE AND
SUBDRAIN INSTALLATION

Samuel A. Johnson
COUNTY ENGINEER RCE 17995

DATE: JANUARY 1999

P-10 TRENCH BACKFILL TYPICAL SECTION

Formatted: Centered

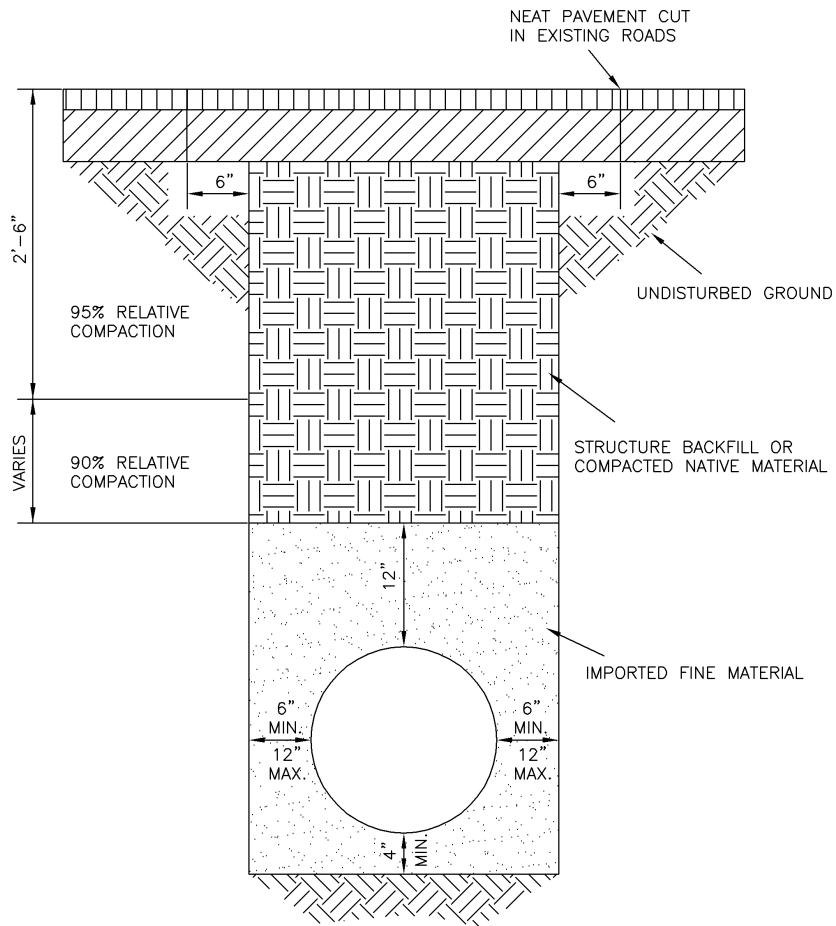

NOT TO SCALE

COUNTY OF NAPA
DEPT. OF PUBLIC WORKS

TRENCH BACKFILL
TYPICAL SECTION

Kenneth H. Johnson
COUNTY ENGINEER RCE 17995

JAN 1999

P-11 DRAINAGE OUTLET

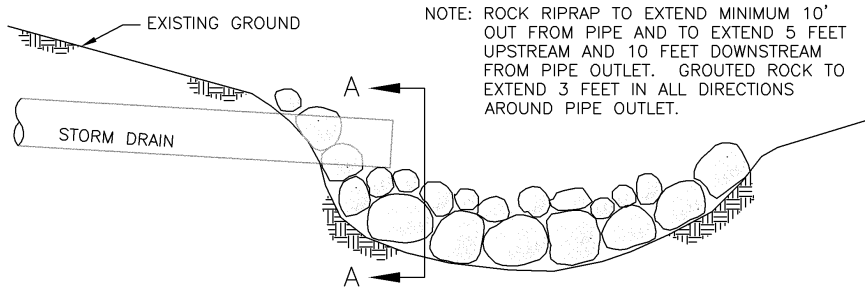

OUTLET (flush type, subcritical flow only)

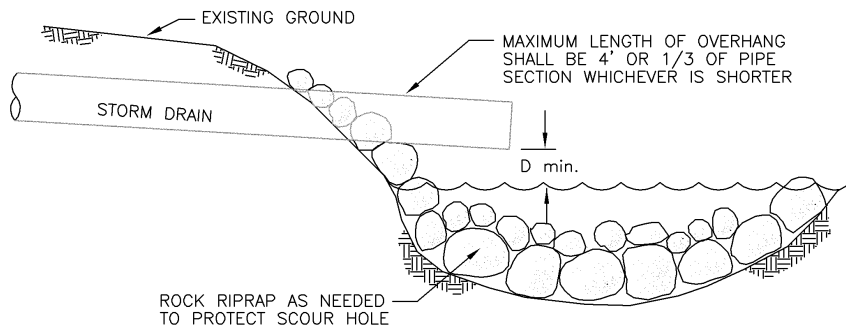

OUTLET (drop type)

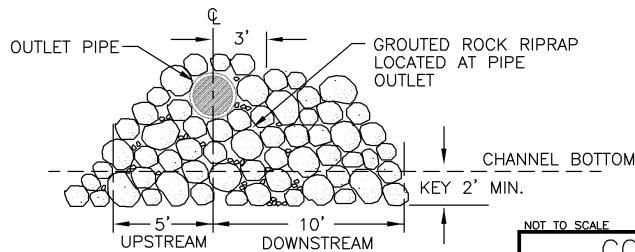

SECTION A-A

NOTE: INSTALL FLAP GATE ANIMAL GUARDS ON DRAINLINE OUTLET PIPES 15" AND SMALLER
ADDITIONAL INFORMATION AVAILABLE AT PUBLIC WORKS OFFICE

COUNTY OF NAPA DEPT. OF PUBLIC WORKS	
DRAINLINE OUTLET	
COUNTY ENGINEER <i>Kenneth H. Johnson</i>	RCE 17995
JAN 1999	

D-1 STORM DRAIN INLET TYPE "A"

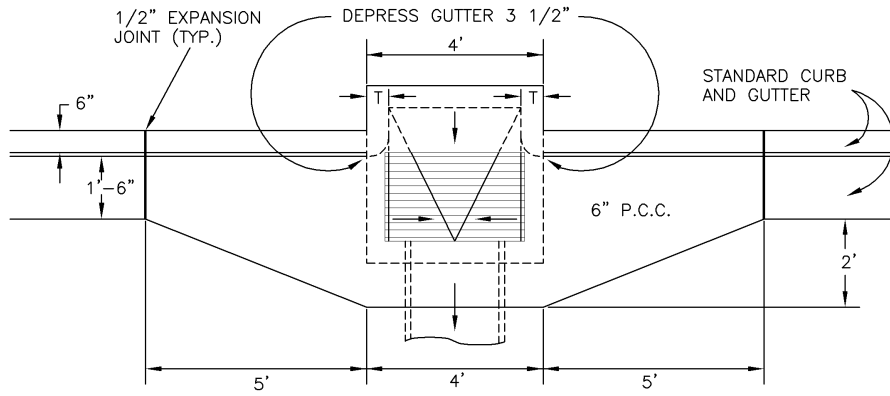

PLAN VIEW

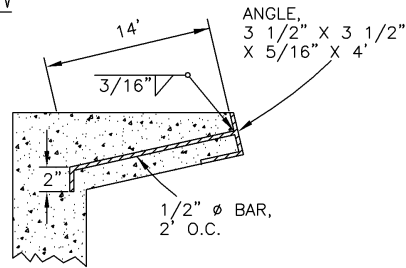

FACE ANGLE ANCHOR DETAIL

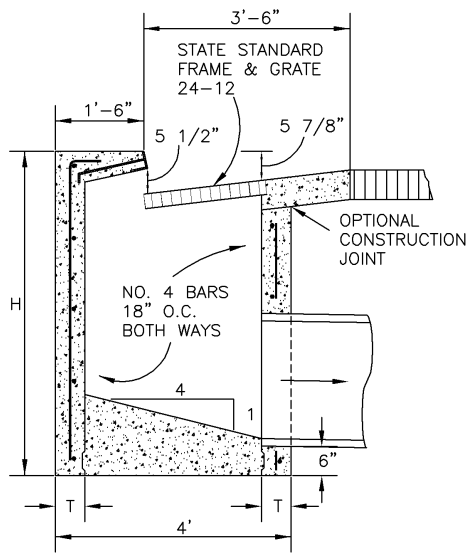

SECTION

NOTE:
T = 6" WHEN H < 8'
T = 8" WHEN H > 8'
NORMALLY USED IN SUMP CONDITION

NOT TO SCALE

COUNTY OF NAPA
DEPT. OF PUBLIC WORKS

STORM DRAIN INLET
TYPE "A"

Samuel D. Johnson
COUNTY ENGINEER RCE 17995

JAN 1999

D-2 STORM DRAIN INLET TYPE "B"

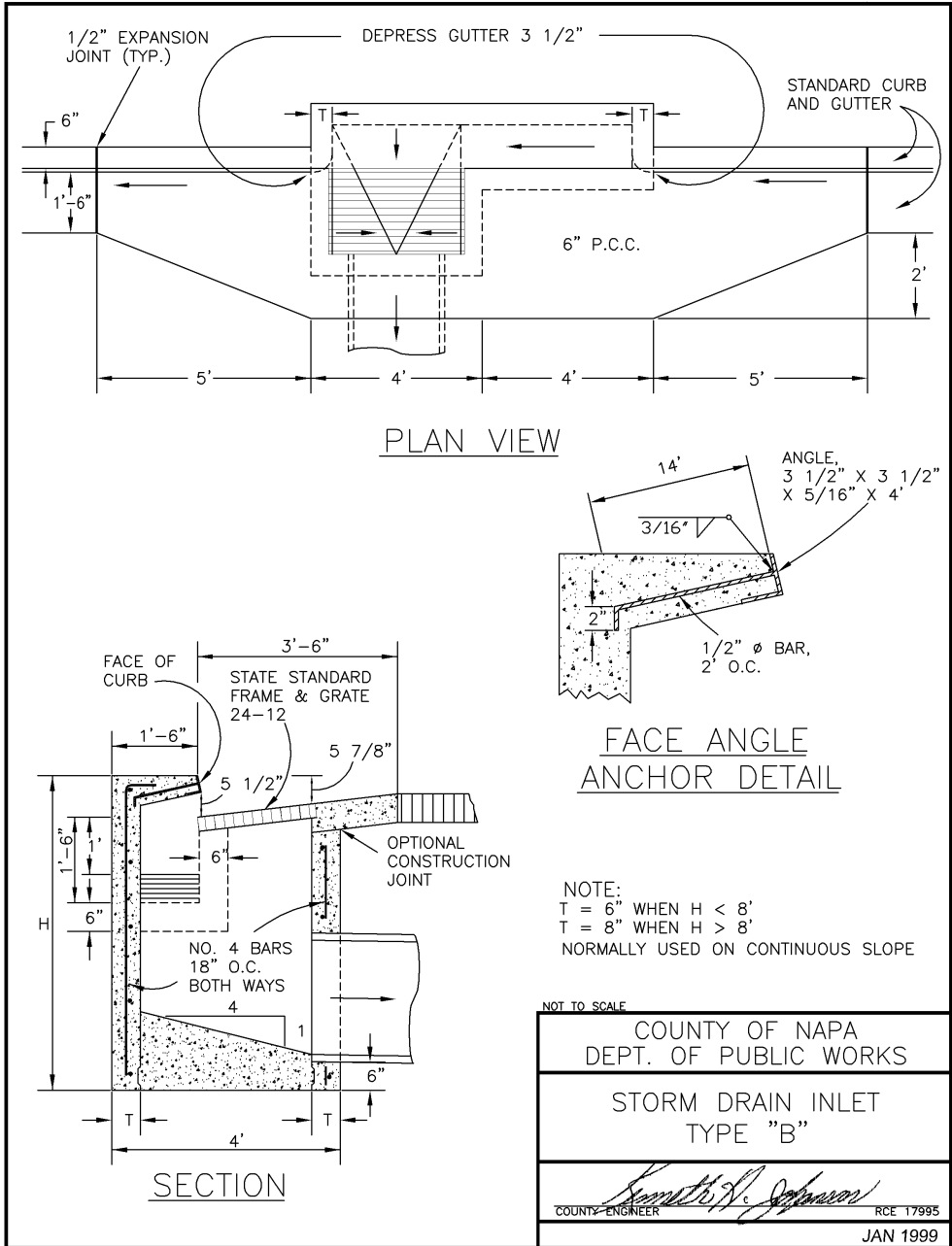

D-3 STORM DRAIN INLET TYPE "C"

Formatted: Centered

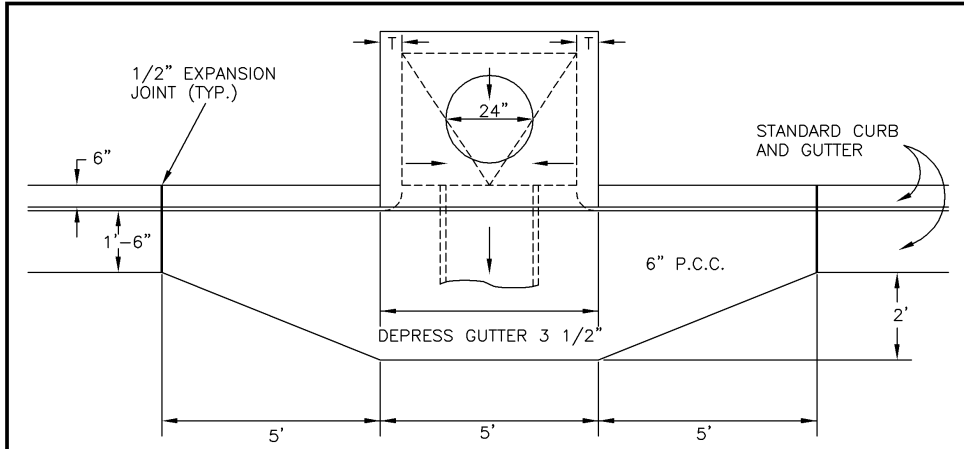

PLAN VIEW

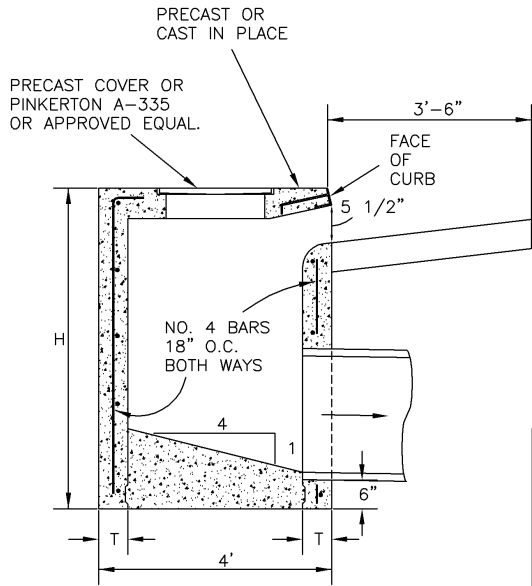

SECTION

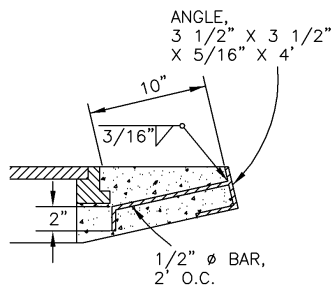

FACE ANGLE ANCHOR DETAIL

NOTE:
 T = 6" WHEN H < 8'
 T = 8" WHEN H > 8'
 NORMALLY USED IN SUMP CONDITION

NOT TO SCALE

COUNTY OF NAPA DEPT. OF PUBLIC WORKS
STORM DRAIN INLET TYPE "C"
<i>Samuel H. Johnson</i> COUNTY ENGINEER RCE 17995
JAN 1999

D-4 STANDARD BARRICADE

Formatted: Centered

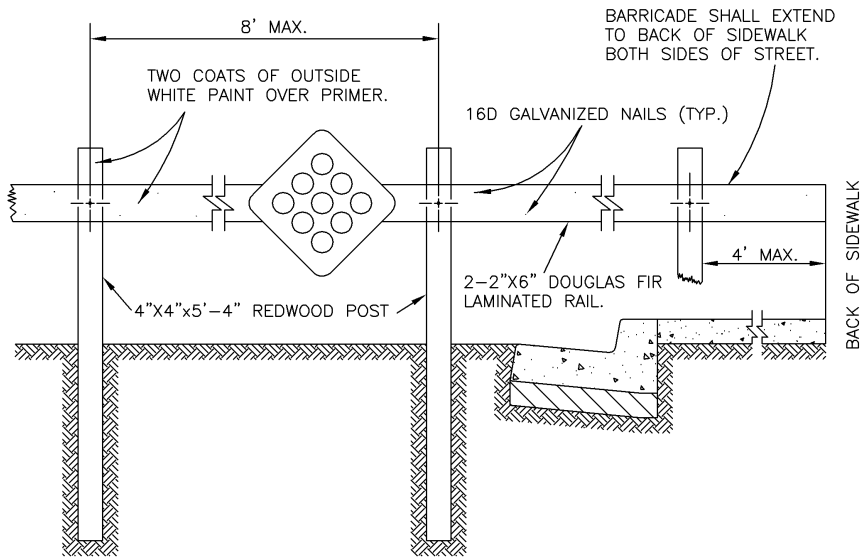

1/2"Ø CARRIAGE BOLTS WITH CUT WASHER. BOLTS SHALL BE GALVANIZED. BURR THREADS TO PREVENT REMOVAL.

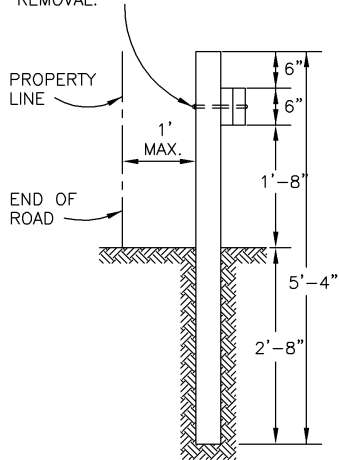

NOTE:
1-TYPE "N" MARKER SIGN TO BE MOUNTED ON BARRICADE FACING ONCOMING TRAFFIC.

NOT TO SCALE

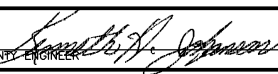
COUNTY OF NAPA DEPT. OF PUBLIC WORKS	
STANDARD BARRICADE	
 COUNTY ENGINEER	RCE 17995
JAN 1999	

D-5 DRIVEWAY SETBACK

Formatted: Centered

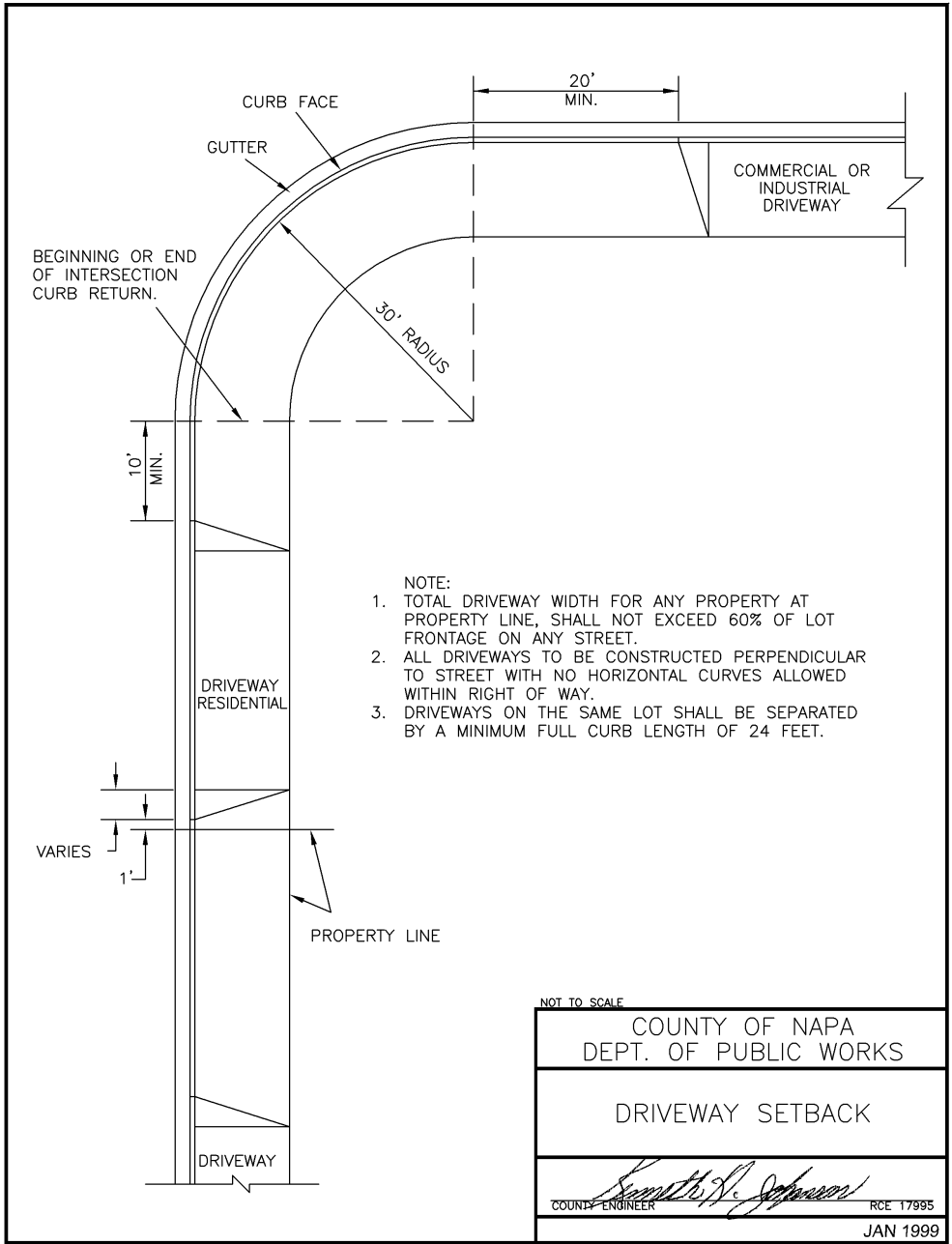

D-6 STANDARD STREET SIGN

Formatted: Centered

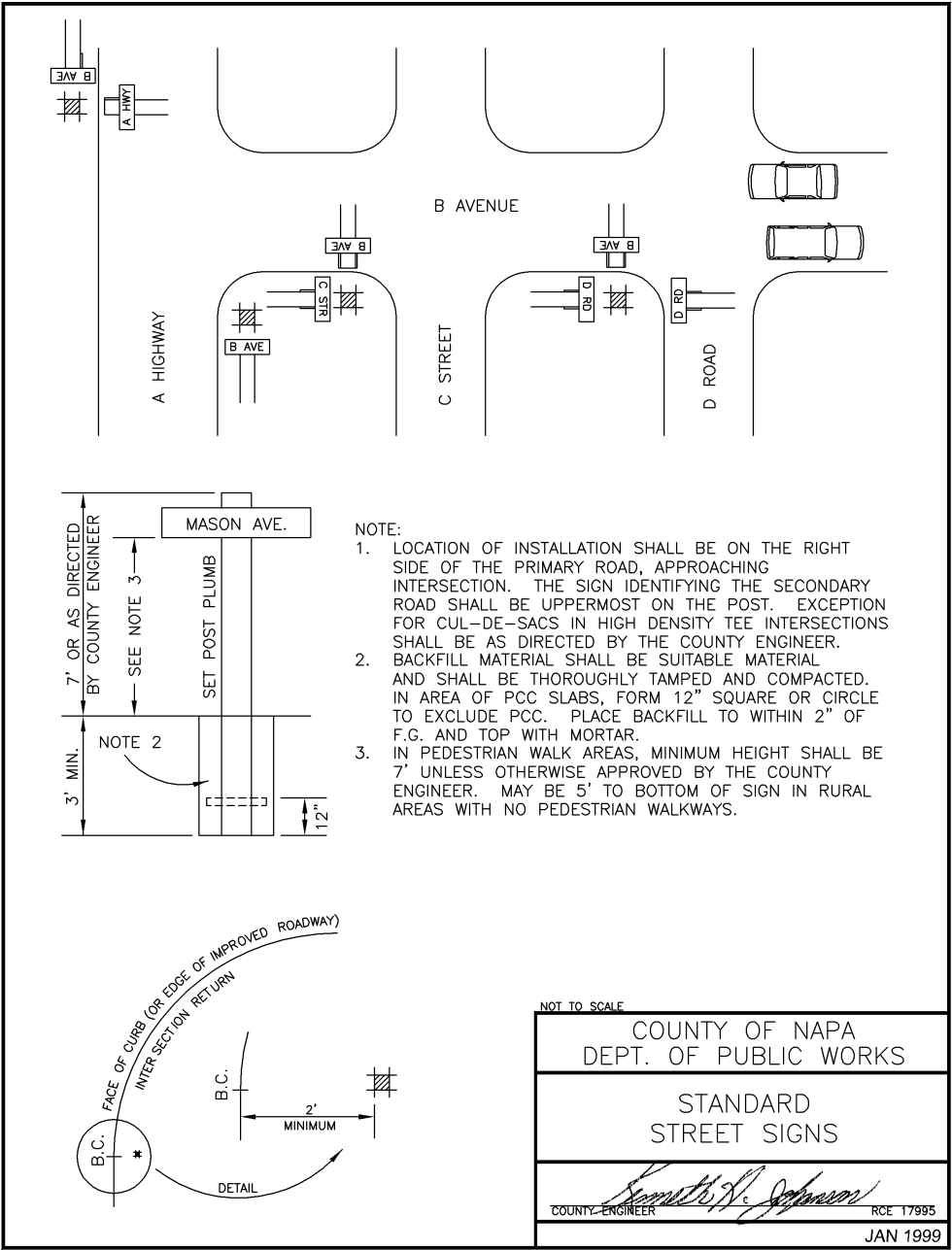

NOT TO SCALE

COUNTY OF NAPA
DEPT. OF PUBLIC WORKS

STANDARD
STREET SIGNS

Samuel H. Johnson
COUNTY ENGINEER RCE 17995

JAN 1999

D-6A STANDARD STREET SIGNS, TYPE 'A' AND TYPE 'B'

Formatted: Centered

STANDARD STREET SIGNS

Street Sign Type A

- Size: 30"x9" (36"x9" may be used where additional length is required due to length of copy. If 36" is not sufficient, copy shall be on two lines and size shall be 30" x 18" and 36"x18" may be used if necessary.) If directional arrow is necessary, size shall be as specified for State of California Department of Transportation Type G-7 "Street Name" sign.
- Material: .125 gage thickness sheet aluminum 6061-T6 alloy or 5052-H38, State of California "Interstate Green" high intensity wide angle retroreflective sheeting.
- Copy: All copy to be in 6" Series C upper case letters, and 4 ½" Series C lower case letters, nomenclature for street, road, avenue, etc.
- Borders: All borders to be ½" wide with radiused comers die cut white high intensity wide angle retroreflective sheeting.
- Layout: Letter spacing and copy layout to be similar to State of California Department of Transportation Type C 1-7 "Street Name Sign"
- Fabrication: Blanks to be cut to size with approximately ½" rounding of the comers; two (2) holes drilled for ¾" bolt mountings, ½" inset on center of blanks: face to be of State of California specification "Interstate Green" high intensity wide angle retroreflective sheeting prior to the application of the copy and borders. All copy, borders and sheeting to be applied by the thermo-vacuum process. Copy shall be edge sealed when applied.
- Installation: Signs to be mounted on 4" x 4" S4S Redwood or 4" x 4" S4S pressure treated Douglas Fir posts of length necessitated by physical conditions, per State of California Standard Specifications. ¾" dia. Carriage bolts with nuts and 1" dia. Washers (all galvanized) for fasteners. Alternate post material and installation will be considered but approval must be obtained prior to installation.

Street Sign Type B

(For installation on State Highways, County Major Arterial Highways and County Major Roads).

- Size: 30"x24" (36" x 24" may be used where additional length is required due to length of copy. If 36" is not sufficient, copy shall be on two lines and size shall be 42"x30" and, 42"x36" with full back framing.
- Copy: All copy to be in 8" Series C upper case letters and 6" lower case letters. An arrow 17.25" total length denoting left or right or both ways as may be required, to appear below the road name. Copy and arrow to be die cut from white high intensity wide angel retroreflective sheeting.
- Layout: Letter spacing and copy layout to be similar to State of California Department of Transportation Type G-8-22 Street Name Sign.

Material, fabrication and Installation: Same as Type A.

SUBDIVISION STREET MONUMENTS ACCURACY

**NAPA COUNTY ENGINEERING AND
ROAD DEPARTMENT**

SUBDIVISIONS STREET MONUMENTS

Following is the current established policy of this department for allowable error for subdivision street monuments:

<u>Slope of 75% Of Land</u>	<u>Distance Between Monuments</u>	<u>Angle Between Tangents and/or Chord</u>
0 < 8%	1 / 50,000	4 seconds
8 < 15%	1 / 25,000	8 seconds
15% <	1 / 15,000	14 seconds

D-7 SURVEY MONUMENT

Formatted: Centered

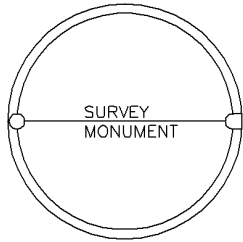

COVER PLAN

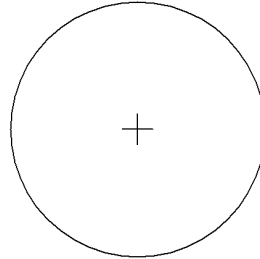

CAP PLAN

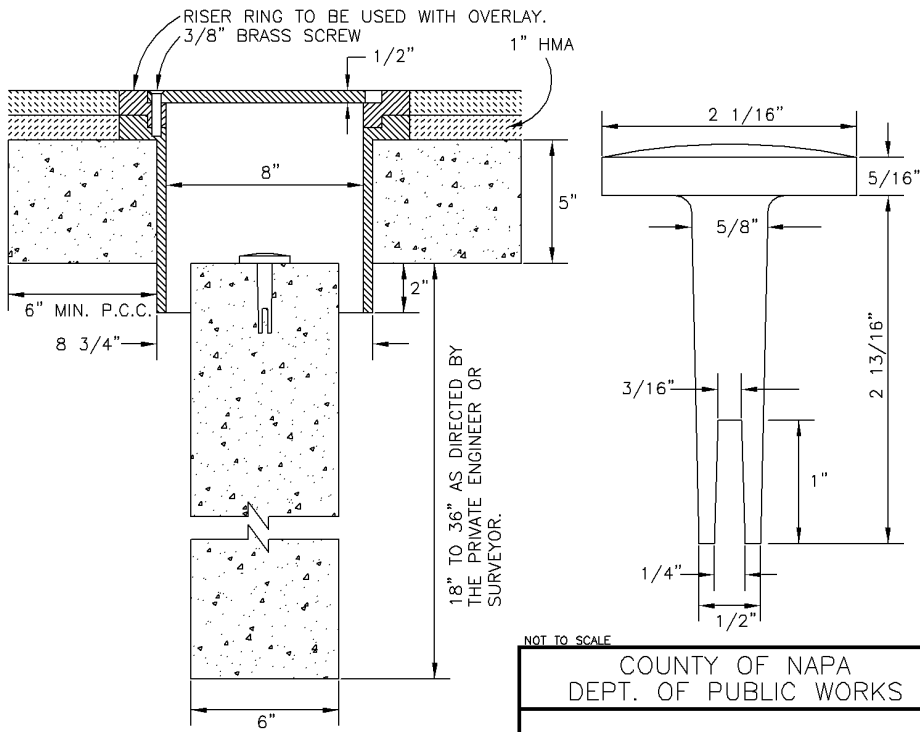

NOTE:
THE PRIVATE ENGINEER OR SURVEYOR SETTING
THE MONUMENT SHALL INDICATE THE EXACT POINT
BY MARKING A CROSS ON THE CAP. HE SHALL
STAMP HIS LICENSE TYPE AND NUMBER.

NOT TO SCALE

COUNTY OF NAPA
DEPT. OF PUBLIC WORKS

SURVEY MONUMENT

COUNTY ENGINEER

RCE 17995

DATE: JANUARY 1999

D-8 OFF STREET PARKING

Formatted: Centered

NOTES

1. ALL PARKING AREAS AND DRIVEWAY ACCESS THERETO SHALL BE IMPROVED TO A DUST FREE ALL WEATHER SURFACE - A MINIMUM OF 5 INCHES OF CLASS 2 AGGREGATE BASE AND EITHER 2 INCHES OF ASPHALT CONCRETE OR A DOUBLE SEALCOAT. (THE OPTION SHALL BE THE CHOICE OF THE COUNTY ENGINEER.)
2. WHERE PUBLIC PARKING STALLS ARE ADJACENT TO PUBLIC RIGHTS OF WAY OR PEDESTRIAN PATHS, AN ACCEPTABLE BARRIER SHALL BE INSTALLED TO PREVENT ENCROACHMENT.
3. PARKING STALLS SHALL BE DELINEATED TO THE SATISFACTION OF THE COUNTY ENGINEER.
4. THE NUMBER OF STALLS NECESSARY SHALL BE DETERMINED BY THE CONSERVATION DEVELOPMENT AND PLANNING DEPARTMENT IN CONFORMANCE WITH COUNTY ORDINANCES.
5. ALTERNATE CONFIGURATION AND PAVEMENT SECTION MAY BE CONSIDERED BY THE COUNTY ENGINEER.
6. WHERE THROUGH CIRCULATION DOES NOT EXIST, PROVISIONS FOR TURN AROUND SHALL BE PROVIDED.
7. THE FRONT TWO FEET OF REQUIRED PARKING LENGTH MAY BE USED TO ENLARGE ADJACENT LANDSCAPING BUT NOT USED TO MEET MIN. LANDSCAPING REQUIREMENTS. LANDSCAPING WITHIN OVERHANG SHALL BE LIMITED TO LOW-LYING SHRUBS AND GROUND COVER.
8. A MAXIMUM OF 35% OF THE STALLS IN PARKING LOTS OF MORE THAN TWENTY SPACES MAY BE DESIGNATED FOR COMPACT CARS. THE STALL WIDTH MAY BE REDUCED BY ONE FOOT AND THE STALL LENGTH MAY BE REDUCED BY THREE FEET.
9. STALLS FOR COMPACT CARS SHALL BE CLEARLY DESIGNATED EITHER BY "COMPACT CARS ONLY" STENCILED ON THE PAVEMENT OR AN 18" BY 18" SIGN STANDING SEVEN FEET HIGH WITH THREE INCH LETTERING.
10. PARALLEL PARKING SPACES SHALL BE 8' X 22' WITH THE FOLLOWING EXCEPTIONS:
 - A. PARALLEL SPACES ALONG A WALL, FENCE OR HEDGE SHALL BE 10 FEET WIDE.
 - B. PARALLEL SPACES HAVING NO OBSTRUCTION OR ADJACENT PARKING SPACE WITHIN TEN FEET OF ONE END MAY REDUCE THE LENGTH TO 20 FEET. IF BOTH ENDS ARE SIMILARLY CLEAR, THE SPACE MAY BE REDUCED TO 18 FEET.

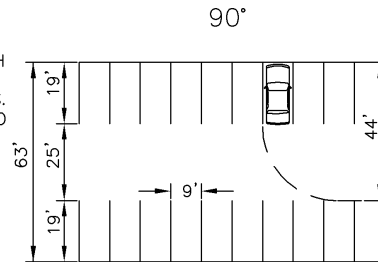
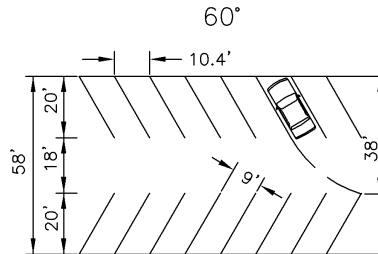
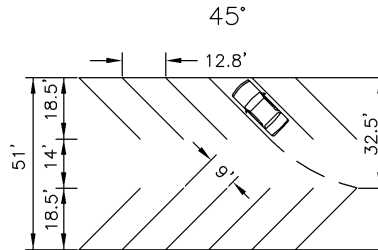

NOT TO SCALE

COUNTY OF NAPA
DEPT. OF PUBLIC WORKS

OFF STREET PARKING

Samuel H. Johnson
COUNTY ENGINEER RCE 17995

JAN 1999

D-9 HANDICAP SYMBOL

Notes:

Location goal: On shortest accessible route to accessible entrance(s).
 Placement goal: Persons with disabilities must not be compelled to wheel or walk behind parked cars other than their own.

Dimensions:

Van: Min 9 feet wide with min 8 feet side loading & unloading *passenger side aisle*, min 18 feet length.

Auto: Min 9 feet wide with min 5 feet wide loading and unloading *passenger side aisle*, min 18 feet long. Two spaces may share the same 5 feet aisle.

Slope: Max 1 vertical to 50 horizontal in any direction.

Signage:

"Van Accessible" for van spaces. Reflectorized International Symbol of Accessibility at each space, min 70 inches sq., min 80 inches high if in path of travel, and unobscured by a parked vehicle. (see symbol below). Tow away sign with telephone number at each entrance to parking area or adjacent to accessible spaces, min size: 17 inches by 22 inches, 1 inch high letters.

Surface Marking: Painted or outlined space in blue and outlined profile view depicting wheelchair with occupant, or 36 inch by 36 inch outlined profile view of wheelchair with occupant in white on blue background visible to traffic enforcement officer when vehicle occupies space.

Curb Ramps: Ramps shall be provided wherever an accessible route crosses a curb. Maximum slope shall be 1:12. Minimum width, exclusive of flares shall be 36 inches. See current California Title 24, Sections 3105A(n) & 3107A of the California Code of Regulations for further information.

Total Number of Parking Spaces	Handicaped Accessible Spaces
1 - 25	1 van accessible space
26 - 50	2 including 1 van accessible space
51 - 75	3 including 1 van accessible space
76 - 100	4 including 1 van accessible space
101 - 150	5 including 1 van accessible space
151 - 200	6 including 1 van accessible space
201 - 300	7 including 1 van accessible space
301 - 400	8 including 1 van accessible space
401 - 500	9 including 2 van accessible spaces
500 - 1000	2% including 3 van accessible spaces
1001 +	20 + 1 per 100 or fraction, including min 1 van accessible space per 8 accessible spaces or fraction thereof.



International Symbol of Accessibility

NOT TO SCALE

COUNTY OF NAPA
 DEPT. OF PUBLIC WORKS

HANDICAP PARKING

[Signature]
 COUNTY ENGINEER

RCE 51790

JUNE 2011

Formatted: Centered

D-10 WHEEL CHAIR RAMP

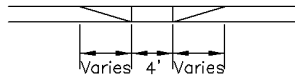
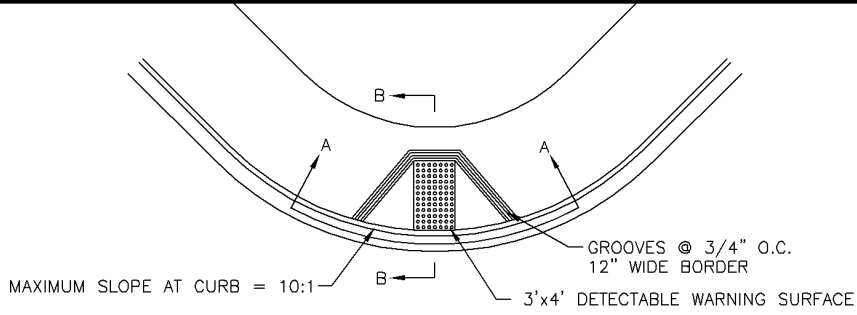

SECTION A-A

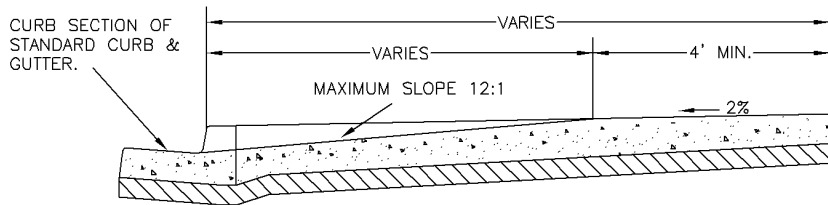

SECTION B-B

1.67"-2.35" CENTER TO CENTER SPACING

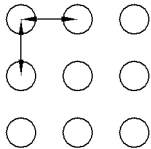

DETECTABLE WARNING

SURFACE DETAIL

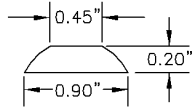

RAISED TRUNCATED DOME DETAIL

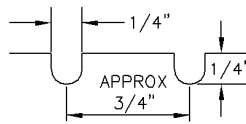

GROOVE DETAIL

NOTES:

1. WHEELCHAIR RAMPS ARE TO BE LOCATED AT THE CENTER OF THE RETURN.
2. RAMP SURFACES THAT ARE NOT GROOVED SHALL BE FINISHED WITH A ROUGHER SURFACE THAN THE SURROUNDING SURFACE.
3. WHEN EXISTING FACILITIES ARE NONCONFORMING OR RIGHT OF WAY LIMITATIONS EXIST, RAMPS MAY BE MODIFIED AS APPROVED BY THE COUNTY ENGINEER. SEE CALTRANS STANDARD PLANS SHEET A88A FOR OPTIONS AND OTHER DETAILS.

NOT TO SCALE

COUNTY OF NAPA DEPT. OF PUBLIC WORKS	
WHEEL CHAIR RAMP	
	RCE 51790
COUNTY ENGINEER	JUNE 2011

D-11 GATED ENTRANCE

① GATE SET BACK SHALL BE 30' MIN. FROM E.O.P. OR 42' MIN. FROM CENTER LINE OF COUNTY ROAD WHICHEVER DISTANCE IS GREATER.

SEE DETAIL P-2 FOR CONNECTION TO COUNTY ROAD IN RURAL AREA

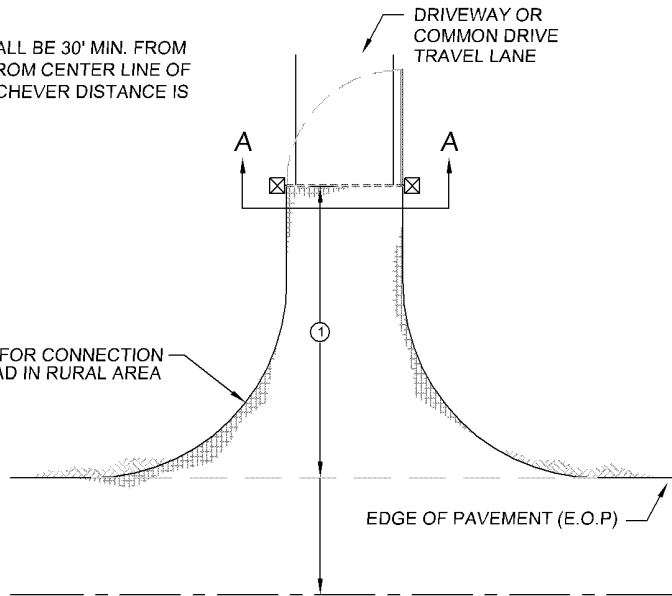

DRIVEWAY OR COMMON DRIVE TRAVEL LANE

EDGE OF PAVEMENT (E.O.P)

NOTES:

1. FOR GATES THAT SWING TOWARD PUBLIC ROADWAY THE MINIMUM SET BACK SHALL BE A TOTAL OF THE SET BACK DISTANCE PLUS THE TOTAL WIDTH OF THE GATE PLUS 2 FEET.

2. ALL GATES SHALL HAVE A CAL FIRE APPROVED KEY ACCESS:

a) ELECTRIC GATES SHALL HAVE A KNOX KEY SWITCH MOUNTED TO ACCESS PANEL.

b) MANUAL GATES SHALL HAVE A KNOX PADLOCK INSTALLED.

3. FOR GATES THAT MEET SET BACK REQUIREMENTS AND ARE STILL IN THE COUNTY RIGHT-OF-WAY, THE PROPERTY OWNER SHALL OBTAIN A RECORDED ENCROACHMENT PERMIT FOR THE GATE STRUCTURE.

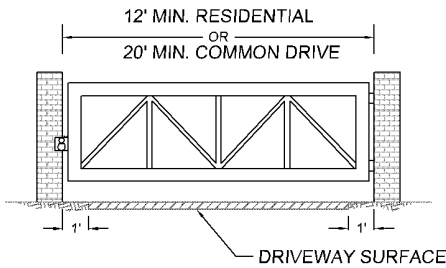

SECTION A-A

NOT TO SCALE

COUNTY OF NAPA DEPT. OF PUBLIC WORKS	
GATED ENTRY	
COUNTY ENGINEER <i>[Signature]</i>	RCE 51790
JUNE 2011	

~~D-12 STANDARD GATE~~

Formatted: Centered